

Free dissemination

(Contract- TREN/D1/40-2005/LOT8/S07.56452)
Preparatory Studies for Eco-design Requirements of EuPs

Final Report

Lot 8: Office lighting

**P. Van Tichelen, B. Jansen , T. Geerken, M. Vanden Bosch (Laborelec),
V. VanHoof, L. Vanhooydonck (Kreios), A. Vercalsteren**

**Study for the European Commission DGTREN unit D3,
contact: Andras Toth**

Contractor



Subcontractors:



2007/ETE/R/115



VITO

April 2007

DISCLAIMER & IMPORTANT NOTE

The authors accept no liability for any material or immaterial direct or indirect damage resulting from the use of this report or its content.

Note: This report contains the results of research by the authors and is not to be perceived as the opinion of the European Commission. In a multi-stakeholder consultation a number of groups and experts provided comments on a preliminary draft of this report prepared by Vito. The report was then revised, benefiting from stakeholder perspectives and input. The views expressed in the report remain those of the authors and do not necessarily reflect the views of the European Commission or the individuals and organisations that participated in the consultation.

TABLE OF CONTENTS

0	EXECUTIVE SUMMARY	13
1	PRODUCT DEFINITION	17
1.1	Product category and performance assessment	17
1.1.1	System boundary and technical product definition.....	17
1.1.2	Prodcom classification of office luminaires, lamps and ballasts.....	21
1.1.3	Performance requirements for office lighting.....	22
1.1.4	Segmentation of luminaires.....	24
1.1.5	Segmentation of ballasts	27
1.1.6	Segmentation of lamps	30
1.1.7	Functional unit for office lighting.....	33
1.2	Lighting test standards or guidelines	34
1.2.1	Standards and guidelines related to the functional unit	34
1.2.2	Other test standards and guidelines not related to the functional unit.....	39
1.3	Existing legislation	44
1.3.1	Legislation and Agreements at European Community level.....	44
1.3.2	Legislation at Member State level.....	48
1.3.3	Third Country Legislation	48
2	ECONOMIC AND MARKET ANALYSIS	53
2.1	Generic economic data	53
2.1.1	Data retrieval	53
2.1.2	Generic economic data lamps	54
2.1.3	Generic economic data ballasts.....	56
2.1.4	Generic economic data luminaires.....	58
2.1.5	Overview and conclusions	59
2.2	Market and stock data.....	60
2.2.1	Data retrieval	61
2.2.2	Current sales lamps	62
2.2.3	Current sales office luminaires	67
2.2.4	Current sales ballasts	67
2.2.5	Current stock lamps in offices.....	69
2.2.6	Current stock of ballasts in offices	72
2.2.7	Current installed base: lighting control.....	73
2.2.8	Current stock luminaires in offices.....	75
2.2.9	Past and future stock of office luminaires.....	76
2.3	Market trends	83
2.3.1	General trends in product design and features from marketing point of view	83
2.3.2	Description of market and production structure and identification of major players.....	85
2.3.3	Duration of redesign cycle of the EuP.....	86
2.3.4	Latest consumer tests	87
2.4	Consumer expenditure data	88
2.4.1	Product prices	88
2.4.2	Electricity rates	89

2.4.3	Repair, maintenance and installation costs	91
2.4.4	Interest and inflation rate.....	91
3	CONSUMER BEHAVIOUR AND LOCAL INFRASTRUCTURE	93
3.1	Definition of 'consumer'	93
3.2	Real Life Efficiency and quantification of relevant parameters.....	94
3.2.1	Lamp efficacy, lamp efficiency, lamp colour spectra and the sensitivity of the human eye	94
3.2.2	Influence of maintenance factors (LMF, LLMF, RSMF).....	96
3.2.3	User influence on switching schemes (annual operating time).....	98
3.2.4	External factors influencing energy consumption during real use.....	100
3.3	End-of Life behaviour related to consumers	103
3.4	Local infra-structure and facilities	105
3.4.1	Influence of local infrastructure on the lighting installation.....	105
3.4.2	Influence on the number of lamps per ballast.....	108
3.4.3	Impact of the over dimensioning of the task area relative to the surrounding area in real circumstances	108
3.4.4	Lack of interest by the office building owner	109
3.4.5	Lack of knowledge or skilled subcontractors	109
3.4.6	Lack of user acceptance for automatic control systems	109
4	TECHNICAL ANALYSIS EXISTING PRODUCTS.....	111
4.1	Production phase	111
4.1.1	Introduction	111
4.1.2	Lamps production	113
4.1.3	Ballasts (control gear) production.....	114
4.1.4	Luminaires production.....	118
4.2	Distribution phase.....	119
4.3	Use phase (product)	119
4.3.1	Rated annual resources consumption (energy, lamps) during product life according to the test standards defined in chapter 1	120
4.3.2	Assessment of resources consumption (energy, lamps) during product life in off-standard conditions (i.e. at variable load).....	134
4.4	Use phase (system).....	134
4.5	End-of-life phase	139
5	DEFINITION OF THE BASE CASE	141
5.1	Product-specific inputs	143
5.2	Base case Environmental Impact Assessment.....	147
5.3	Life Cycle Costs	152
5.4	EU Totals	153
6	TECHNICAL ANALYSIS BAT AND BNAT.....	157
6.1	BAT State-of the art in applied research.....	157
6.1.1	Luminaires with improved luminaire maintenance factor (LMF).....	157
6.1.2	Luminaires with daylight responsive dimming	158
6.1.3	Luminaires with dimming ballasts that compensate for luminaire pollution or room surface reflection deviations over its lifetime.....	159
6.1.4	Luminaires with presence detection	159

6.1.5	Improved fluorescent lamp types	160
6.1.6	Improved efficiency for electronic ballasts compared to CELMA EEI = A2 & A1	163
6.1.7	Electronic dimmable ballasts.....	165
6.1.8	High reflectance aluminium material	166
6.2	State-of the art of best existing product technology outside the EU	166
6.3	BNAT in applied research.....	167
6.3.1	New luminaires for WLED SSL lamps.....	167
6.3.2	New luminaires for OLED lamps.....	168
6.3.3	WLED SSL lamps.....	168
6.3.4	OLED lamps	170
7	IMPROVEMENT POTENTIAL.....	171
7.1	Improvement options with cost and impact assessment.....	172
7.2	Analysis LLCC and BAT	176
7.3	Long-term targets (BNAT) and system analysis	180
7.3.1	Market introduction of BNAT new LED luminaires.....	180
7.3.2	Market introduction of BNAT new OLED luminaires.....	181
7.3.3	System related improvement potential	181
8	SCENARIO- POLICY- IMPACT- AND SENSITIVITY ANALYSIS	183
	183
8.1	Policy- and scenario analysis.....	183
8.1.1	Eco-design requirements	183
8.1.2	Scenario analysis	197
8.1.3	Sensitivity analysis.....	208
8.1.4	Suggested additional requirements for the appropriate putting into service.....	216
8.1.5	Required new or updated measurement or product standards.....	217
8.1.6	Suggested additional research.....	217
8.2	Impact analysis industry and consumers.....	217
8.2.1	Potential application of the ecodesign requirements outside the defined product category.....	217
8.2.2	Warnings for avoiding negative impact on consumers outside the defined product category.....	221
8.2.3	Warnings and additional measures for avoiding potential negative impact on industry from products in the defined product category.....	221
8.2.4	Overall impact and conclusion when implementing the BAT scenario	222
9	REFERENCES.....	223
10	ABBREVIATIONS AND ACRONYMS	227
ANNEX A: PRODCOM CATEGORIES OF RELEVANT LIGHTING		
	PARTS APPLICABLE IN OFFICE LIGHTING	233
ANNEX B: EUROPROMS RESULTS FOR THE TWO MOST RELEVANT LAMP TYPES APPLICABLE IN OFFICE LIGHTING		235
ANNEX C: OVERVIEW OF PRODUCTION, TRADE AND CONSUMPTION DATA FOR LAMP TYPES APPLICABLE IN OFFICE LIGHTING		237

ANNEX D: EUROPROMS RESULTS FOR BALLAST AND BALLAST PARTS APPLICABLE IN OFFICE LIGHTING	239
ANNEX E: OVERVIEW OF PRODUCTION, TRADE AND CONSUMPTION DATA FOR BALLAST AND BALLAST PARTS APPLICABLE IN OFFICE LIGHTING.....	241
ANNEX F: EUROPROMS RESULTS FOR CATEGORIES OF LUMINAIRES IN OFFICE LIGHTING.....	243
ANNEX G: OVERVIEW OF LAMP AND BALLAST PRODUCTION, TRADE AND CONSUMPTION IN EU-25 IN 2004.....	248
ANNEX H: EU-25 LAMP SALES	252
ANNEX I: CHARACTERIZATION OF THE EUROPEAN BUILDING STOCK.....	254
ANNEX J: OFFICE STOCK PROJECTIONS TO 2030: FROM EMPLOYMENT TO OFFICE DEMAND	256
ANNEX K: EXPERT INQUIRY	258
ANNEX L: STAKEHOLDER LIST ON 19TH JUNE 2007.	265

LIST OF TABLES

Table 1: Performance requirements for office work on task areas with “high demand” (Source: EN 12464-1).....	23
Table 2: Uniformities and relationship of illuminance of immediate surrounding areas to task area.....	23
Table 3: Example for the CELMA ballast labelling system-Maximum input power requirements for linear T8 fluorescent ballast lamp circuits in Watt.....	29
Table 4: Overview of lamp types with acronyms and related standards	31
Table 5 Characteristic letter for luminaire light distribution classes.	35
Table 6 Characteristic numbers for luminaire light distribution classes.	36
Table 7 Minimum luminaire efficacy values according to light distribution.....	37
Table 8 Best practice luminaire efficacy values according to light distribution.....	37
Table 9: Mandatory Label for Ballasts (Electronic).....	49
Table 10: Voluntary Label for Ballasts (Electronic).....	49
Table 11: Minimum Energy Performance Standard - Mandatory for Ballasts (Electronic)	50
Table 12: Mandatory Label for Ballasts (Magnetic).....	50
Table 13: Voluntary Label for Ballasts (Magnetic)	50
Table 14: Minimum Energy Performance Standard - Mandatory for Ballasts (Magnetic)	51
Table 15: Minimum standards and labelling programs applied worldwide for CFL (source www.apec-esis.org).	52
Table 16 : Office Lighting categories.....	58
Table 17: Europroms results of 4 office lighting categories according to lamp technology: EU-15 production volume and value (1995, 2000-2002).....	58
Table 18: Overview of generic economic data for lamps and ballasts	59
Table 19: input data required for EU25 totals.....	61
Table 20: Volume of EU-25 lamp sales, 1999-2004	63
Table 21: Volume of EU-25 LFL and CFL lamp sales, 1999-2004	64
Table 22: Lamp types used for new office lighting, in particular task area (Expert Inquiry)....	67
Table 23: Derivation of lamp sales for new luminaires	67
Table 24: Number of new installed lamps driven by different types of ballast and derived ballast sales in 2000-2005	68
Table 25: Lamp types used in office lighting in PACA region, France.....	70
Table 26: Lamp types used in office lighting in 6 EU Member States (DEFU)	72
Table 27: Light sources used for existing office lighting, in particular task area (Expert Inquiry)	72
Table 28: Use of ballast technology in percentage for the public and private office buildings..	73
Table 29: Penetration rate of different lighting control techniques in office lighting.....	74
Table 30: Penetration rate of different lighting control techniques in office lighting in Belgium and Spain (Source: Expert inquiry).....	74
Table 31: Use of lighting technology in percentage for the public and private office buildings (Source: DEFU, 2001).....	76
Table 32: Illuminance levels in lux.....	78
Table 33: Area of new commercial buildings (000’s m ²): 1990-2002 (UNECE).....	80
Table 34: Derivation of office building stock in EU-25 (Novem and Ecofys)	81
Table 35: Recommended and best practice values according to US DOE.	88
Table 36: Electricity prices for household and industry consumers.....	90

Table 37: Estimation of maintenance and installation cost related parameters used for LCC calculations in this study.....	91
Table 38: Lamp efficacy for technological similar lamp types with different colour spectra	95
Table 39: Frequency of inclusion of cleaning of luminaries during maintenance.....	96
Table 40: RSMF and LMF values used in this study	97
Table 41: LLMF and LSF data for selected lamps	98
Table 42: Typical occupancy dependency factors (Foc) (source: prEN15193-1 table D1).....	99
Table 43: Operating hours used in this study	100
Table 44: BMF values for power factor and harmonic current related losses used in this study.	103
Table 45 : Countries with a recycling infrastructure for EoL gas discharge lamps in Europe	104
Table 46: Overview of recovered materials and their customers.....	104
Table 47: Office dimensions for cellular offices used in this study.	105
Table 48: Office dimensions for open plan offices used in this study.	106
Table 49: Reflectance values used in this study.....	106
Table 50: Reflectance values used in SIA 380-4.	107
Table 51: BGF values for daylight savings used in this study.	107
Table 52: LPI values	108
Table 53: BGF values for fine tuning the task area	108
Table 54: Compromising motivating factors of the 'putting into service consumer'.....	109
Table 55: Overview of selected lamps	111
Table 56: Input data for the materials extraction and production of the lamps (expressed in g)	114
Table 57: Input data for the materials extraction and production of the electromagnetic gear (expressed in g).....	116
Table 58: Input data for the materials extraction and production of the electronic ballasts (expressed in g).....	117
Table 59: Input data for the materials extraction and production of the luminaires (expressed in g).....	118
Table 60: Input data for the environmental assessment of the distribution of the lamps and control gear.....	119
Table 61: Input data for the environmental assessment of the distribution of the luminaires..	119
Table 62: Selected lamp efficacy and cost data	124
Table 63: Ballast losses according to CELMA class label	125
Table 64: Performance and cost data for magnetic ballasts with capacitor and starter	126
Table 65: Performance and cost data for electronic ballasts	126
Table 66: UF, performance and cost data for category A1 (direct lighting) in a cellular office	129
Table 67: UF, for category A1 (direct lighting) in an open plan office (the same luminaires as in cellular office).	130
Table 68: UF luminaire performance and cost data for category A2 (direct/indirect lighting) in a cellular office.....	131
Table 69: UF luminaire performance and cost data for category A2 (direct/indirect lighting) in an open plan office	132
Table 70: Minimum , maximum, average and median UFr	133
Table 71: Office reflection values used in this study.....	135
Table 72: UF luminaire performance for category A1 (direct lighting) in a cellular office for room with very dark, typical and bright surface reflectance.....	135

Table 73: UF luminaire performance for category A1 (direct lighting) in an open plan office for room with very dark, typical and bright surface reflectance.....	136
Table 74: UF, UFsoftware, UFb and UFu luminaire performance and cost data for category A2 (direct/indirect lighting) in a cellular office.....	136
Table 75: UF, UFsoftware, UFb and UFu luminaire performance and cost data for category A2 (direct/indirect lighting) in an open plan office.....	137
Table 76: Input data for the environmental assessment of the end of life processing of the lamps, gear and luminaires.....	140
Table 77: input parameters base cases (technical, costs)	144
Table 78: output parameters base cases (technical, costs).....	145
Table 79: non-product specific input parameters LCC	146
Table 80: input parameters for EU25 totals, 2005	146
Table 81: Life Cycle Impact (per unit) of Base case Luminaire A1, A2 and aggregated.....	148
Table 82: comparison of A1 and A2 Base cases per 1000 functional lumen output for open plan and cellular offices	149
Table 83: distribution of impacts over life cycle phases A1 (similar for A2)	150
Table 84: Life Cycle Costs (per unit) luminaire for reference year 2005.....	152
Table 85: EU Total Impact of STOCK of base case Luminaires in 2005 (produced, in use, discarded)	155
Table 86: total annual expenditure in EU25.....	156
Table 87: Overview BAT values EEI-class A1 & A2 ballasts (catalogue research).	164
Table 88: BGF data for dimming options.....	165
Table 89: LMF data for option 6.....	174
Table 90: Control methods considered for options 7 and 9 to 12	175
Table 91: Data for option 8.....	175
Table 92: Proposal for new lighting distribution classes.....	186
Table 93 Proposal for LERc reference values related to lighting distribution classes for luminaires with total lamp luminous flux ($\Phi@25\text{ }^{\circ}\text{C} \geq 2000\text{ lm}$).....	187
Table 94: Proposal for LERc reference values related to lighting distribution classes for luminaires with total lamp luminous flux ($\Phi@25\text{ }^{\circ}\text{C} < 2000\text{ lm}$).....	187
Table 95: Typical model for LMF value specification according to CIE 97	188
Table 96: MEPs proposal for LFL type T8.....	191
Table 97: MEPs proposal for LFL type T5, High Efficiency	192
Table 98: MEPs proposal for LFL type T5, High Output	192
Table 99: MEPs proposal for CFL-ni @ optimum temperature (25°C)	193
Table 100: Minimum LLMF proposal for fluorescent lamps.	193
Table 101 Scenario parameters	197
Table 102: References to data in report for BAT scenarios.....	198
Table 103: Average ballast EEI-class in the installed base and derived correction factors.....	200
Table 104. Aggregated results, Scenario BAU	201
Table 105 Aggregated results, Worst Case Scenario (halophosphate).....	203
Table 106 Aggregated results, Scenario Minimum BAT (MiniBat).....	204
Table 107 Aggregated results, Best Case Scenario (BAT).....	206
Table 108: functional lumen output per luminaire (kWh/1000lm per year)	209
Table 109: LCC under base case assumptions, except luminaire life set to 15 years	211
Table 110: LCC under base case assumptions, except luminaire life set to 15 years and electricity rate set to 0,14 €/kWh.....	211
Table 111: Maintenance costs under 2 different maintenance schemes	212

Table 112: Total EU25 Energy Use (PJ primary)	213
Table 113: Total annual EU25 expenditure (mln.€)	213
Table 114: influence of lowering the average luminaire life to 15 years on EU25 energy use	215
Table 115 Leverage factor for fluorescent lighting applications	219
Table 116 Typical annual operating hours (burning hours) according to CIE 97(2005)	220
Table 117 Typical annual operating hours (burning hours) according to prEN 15193 (annex F).	221
Table 118: Two most relevant lamp types applicable for office lighting.....	233
Table 119: Ballast and ballast parts	233
Table 120 : Office lighting luminaires categories.....	234
Table 121: Fluorescent hot cathode discharge lamps, with double ended cap (excluding ultraviolet lamps): Europroms results	236
Table 122: Fluorescent hot cathode discharge lamps (excluding ultraviolet lamps, with double ended cap): Europroms results	236
Table 123: Overview of ‘Fluorescent hot cathode discharge lamps, with double ended cap (excluding ultraviolet lamps)’ production, trade and consumption data: 2001-2004 (Source: Europroms).....	237
Table 124: Overview of ‘Fluorescent hot cathode discharge lamps (excluding ultraviolet lamps, with double ended cap)’ production, trade and consumption data: 2001-2004 (Source: Europroms).....	238
Table 125: Inductors for discharge lamps or tubes: Europroms results.....	239
Table 126: Ballasts for discharge lamps or tubes (excluding inductors): Europroms results..	240
Table 127: Overview of ‘Inductors for discharge lamps or tubes-ferromagnetic ballasts’ production, trade and consumption data, 2001-2004 (Source: Europroms).....	241
Table 128: Overview of ‘Ballasts for discharge lamps or tubes (excluding inductors)-electronic ballasts’ production, trade and consumption data, 2001-2004 (Source: Europroms)	242
Table 129: Office lighting (task lighting): for incandescent lamps : Europroms results	243
Table 130: Office lighting (task lighting): for compact fluorescent lamps : Europroms results	245
Table 131: Office lighting (task lighting): for other fluorescent lamps : Europroms results...	246
Table 132: Office lighting (task lighting): for other lamps : Europroms results.....	247
Table 133: EU-25 lamp sales, 1999-2004 (Source: rescaled based on population from original ELC sales data for the Western EU market)	252
Table 134: Current floor area of European Office Buildings (Source: Novem, 1999 – SAVE project)	254
Table 135: Characterization of the “new-8” building stock	255
Table 136: Effect of growth of employment on office use in coropregions, 1989-1999	257

LIST OF FIGURES

Figure 1: Typical office luminaires.....	18
Figure 2: Spot lights with halogen lamps at a reception desk (outside the scope of this study)	19
Figure 3 : Standard (floor) luminaire (Inside the scope of this study when they are a special design case of suspended office luminaries using the same technology)	19
Figure 4 : Table lamp (outside the scope of this study)	20
Figure 5 : Emergency lighting (outside the scope of this study)	20
Figure 6: Building management lighting control system components (outside the scope of this study).....	20
Figure 7 : Typical category A2 luminaire when intended for use in offices.	24
Figure 8: Typical category B luminaire when intended for use in office corridors (outside the product boundary).....	25
Figure 9: Category C examples: design luminaire (left) and RGB adaptable color luminaire (right)	25
Figure 10 : Classification of ballast lamp circuit for energy efficiency in lighting.(Source: CELMA Ballast Guide).....	28
Figure 11: Examples of three important lamp types used in this study (left LFL, middle LED, right CFL).....	30
Figure 12 Standard room according to DIN 5040-2.	36
Figure 13: Photorealistic visualization of office lighting	38
Figure 14: Volume of production, trade and sales of lamps for EU25	54
Figure 15: Value of production, trade and sales of lamps for EU25	55
Figure 16: Volume of production, trade and sales of ballasts for EU25.....	56
Figure 17: Value of production, trade and sales of ballasts for EU25	57
Figure 18: Volume of EU-25 lamp sales, 1999-2004	63
Figure 19: Evolution of penetration rate of LFL in EU-25, 1999-2004	65
Figure 20: Evolution of penetration rate of CFL in EU-25, 1999-2004	66
Figure 21: Market share (1997 to 2004) and expected markets hare (2005 to 2010) of the ballasts sales developments in Europe based on operated lamps	69
Figure 22: Likely pattern of change in office space demand due to demographic pressures	82
Figure 23: Energy-efficiency of luminaires according to SIA 380/4.....	87
Figure 24: Best practice contractual relationship between 'Building owner' and 'Producer or importer'.	94
Figure 25: Normalised eye sensitivity for scotopic and photopic vision.	95
Figure 26 Cold spot location for LFL T5 and T8 lamps	101
Figure 27: Luminous flux of T8 LFL in function of ambient temperatures.....	101
Figure 28: Luminous flux of T5 LFL in function of ambient temperatures.....	102
Figure 29: Luminaires fitted with 3 lamps (left) and 1 lamp (right).....	108
Figure 30: Luminous efficacy range of lamp technology (source: Laborelec)	122
Figure 31: Typical lifespan of lamp technology (source: Laborelec).....	122
Figure 32: Downward and upward zones for the calculation of accumulated luminous fluxes	127
Figure 33: UF luminaire data for category A1 (direct lighting) in a cellular office.	130
Figure 34: UF luminaire data for category A1 (direct lighting) in an open plan office.....	130
Figure 35 Comparison of UF values for cellular versus open plan office in category A1 luminaires.....	131

Figure 36 UF luminaire data for category A2 (direct/indirect lighting) in a cellular office	132
Figure 37 UF luminaires data for category A2 (direct/indirect lighting) in a cellular office....	132
Figure 38 Comparison UF values cellular versus open plan office for category A2 luminaires	133
Figure 39 UF luminaire performance for category A1 (direct lighting) in a cellular office for room with very dark, typical and bright surface reflectance.....	135
Figure 40 UF luminaire performance for category A1 (direct lighting) in an open plan office for room with very dark, typical and bright surface reflectance.....	136
Figure 41 UF luminaire performance for category A2 (direct/indirect lighting) in a cellular office for room with very dark, typical and bright surface reflectance.....	137
Figure 42 UF luminaire performance for category A2 (direct/indirect lighting) in an open plan office for room with very dark, typical and bright surface reflectance.....	137
Figure 43: distribution of impacts over luminaire, ballast use, lamp use, electricity use A1 (similar for A2)	149
Figure 44: Luminaire with micro-optic refractor.....	158
Figure 45: Luminaire with daylight responsive sensor.....	158
Figure 46: Luminaire with presence detector incorporated(left) and typical passive infra-red motion detector (right).....	160
Figure 47: Influence of ambient temperature on luminous flux of T5 HO constant lamps, compared to T5 standard lamps.....	162
Figure 48: Multi-layer structure of high reflective aluminium.....	166
Figure 49: Office lighting luminaire with LEDs.....	167
Figure 50: Typical WLED.....	168
Figure 51: OLED prototype (Picture courtesy of OLLA project).....	170
Figure 52: Ranking of options for type A1 luminaires in cellular offices.....	177
Figure 53: Ranking of options for type A1 luminaires in open plan offices	177
Figure 54: Ranking of options for type A2 luminaires in cellular offices.....	179
Figure 55: Ranking of options for type A2 luminaires in open plan offices	179
Figure 56: Ranking of options for type A2 luminaires in cellular offices (2 highly efficient T5 lamps per luminaire for option 14).....	180
Figure 57: Downward and upward zones for the calculation of accumulated luminous fluxes	186
Figure 58: principle that real saving potential is between ‘a’ (relative to worst case) and ‘b’ (relative to standard base case).....	199
Figure 59: Scenario’s Total Energy (GER).....	207
Figure 60: Scenario’s Total Annual Expenditure	207
Figure 61: Total EU25 Energy Use (PJ primary) when changing UF-values.....	209
Figure 62: Ranking of options for type A1 luminaires (cellular offices) when base case UFr is set at the UFr 25% of technically assessed luminaires.	210
Figure 63: Total EU25 Energy Use (PJ primary)	213
Figure 64: Total annual EU25 expenditure (mln.€).....	214
Figure 65: influence of lowering the average luminaire life to 15 years on EU25 energy use	215
Figure 66: Lamp production, trade and consumption volume in EU-25, 2004.....	248
Figure 67: Value of lamp production, trade and consumption in EU-25, 2004	249
Figure 68: Ballast production, trade and consumption volume in EU-25, 2004	250
Figure 69: Value of ballast production, trade and consumption in EU-25, 2004.....	251

0 EXECUTIVE SUMMARY

The aim of this preparatory study is to provide information on whether and which eco-design requirements could be set for office lighting products in order to improve their environmental performance in the framework of Directive 2005/32/EC on eco-design requirements for energy-using products. The structure of this study is according to the MEEUP methodology and contains the typical 8 chapters. In a multi-stakeholder consultation, a number of groups and experts provided comments on a preliminary draft of this report. The report was then revised, benefiting from stakeholder perspectives and input. The views expressed in the report remain those of the authors, and do not necessarily reflect the views of the European Commission or the individuals and organisations that participated in the consultation. A list of stakeholders that participated in this consultation is included in the appendix.

The MEEUP methodology report structure distinguishes 8 product specific chapters:

1. Product Definition;
2. Market and economic analysis;
3. Consumer Behaviour & Local Infrastructure;
4. Technical Analysis Existing Products;
5. Definition of Base Case(s);
6. Technical Analysis of Best Available Technology(BAT) and BNAT;
7. Improvement Potential;
8. Scenario, Policy, Impact and Sensitivity Analyses.

A project report is published together with this study, providing more background on how the preparatory study was conceived and the process to arrive at the results.

Lighting equipment is without doubt an important energy using product that has been installed in office buildings of the tertiary and industrial sector for many decades. It is common practice to install task oriented lighting according to specified technical requirements in indoor work areas of the tertiary and industrial sector in accordance with technical standards or guidelines (e.g. EN 12464-1(2002)). For reasons mentioned in chapter 1, this report has an important focus on the fixed lighting products that are installed in the office task area intended to perform visual tasks. The lighting requirements for this office task area are included in standard EN 12464-1(2002) called 'Lighting of work places- Part 1: Indoor work places' and the typical required illuminance on the task area is 500 lux. This standard EN 12464-1(2002) also includes other comfort requirements on glare and colour rendering. The fixed lighting equipment installed during the last decades to fulfil these requirements is almost without exception based on fluorescent lamp technology and it is expected that this technology will be the base case for another decade. Fluorescent lamp technology and the related ballast and luminaire technology did still make significant performance progress in the last two decades. A broad range of performance levels of these products is installed in buildings and is put on the market nowadays; therefore implementing measures are recommended. For example, old halophosphate fluorescent lamp technology cannot satisfy the colour rendering requirements of EN 12464-1 (2002) and has a poor lamp efficiency. Nevertheless halophosphate lamp sales are still considerable, probably either as replacement lamp or in applications where no technical lighting requirements are imposed (e.g. domestic).

Fluorescent lamps and ballasts can be bought separately. Luminaires for fluorescent lamps are sold including a ballast with or without a lamp.

Please note that the related directive 2000/55/EC on energy efficiency requirements for ballasts for fluorescent lighting is already in force and will be reconsidered in this study. Please note also that estimating the total lighting energy consumption in office buildings is part of directive 2002/91/EC on the energy performance of buildings. The directive 2002/95/EC on Restriction of the use of certain Hazardous Substances in electrical and electronic equipment (RoHS) contains exceptions on mercury content for fluorescent lamps, recommendations are given for a revision of this directive too.

Identical lighting technology is used in other professional indoor lighting applications as mentioned in chapter 8. The eco-design study is performed for the most typical office application environment and did allow to perform a clear functional analysis according to the MEEUP methodology. The EU25 total environmental impact is therefore assessed for the office task area application in the first place but based on total sales numbers a leverage factor can be estimated for extrapolation to other applications of identical products. This leverage factor for non office task area fluorescent lighting applications is estimated about a factor 6.

This study points out that the largest environmental impact comes from the use of electricity according to the MEEUP methodology applied to all quantified parameters (see chapter 5). If products placed on the market relied on the latest best available technology, a significant reduction on environmental impact could be realised as pointed out in this study.

Finally, the following eco-design options are recommended for further consultation (see chapter 8) by the EC on the implementation of Directive 2005/32/EC:

- Generic Eco-design requirements for the supply of information for fluorescent lamps, luminaires and ballasts including the labelling of luminaires;
- Specific ecodesign requirements for increasing the fluorescent lamp efficacy and reducing lamp mercury, having for effect a.o. the phasing out of inefficient halophosphate fluorescent lamps;
- Specific ecodesign requirements for increasing the fluorescent lamp ballast efficiency and increasing the use of dimmable ballasts for high power fluorescent lamps by updating the existing directive 2000/55/EC on energy efficiency requirements for ballasts for fluorescent lighting;
- Specific eco-design requirements for maximum stand by losses;
- Specific ecodesign requirements for increasing the luminaire maintenance factor for open indoor luminaires with fluorescent lamps;
- Specific ecodesign requirements for increasing the optic efficiency by increasing the luminaire efficacy for open luminaires with fluorescent lamps;

Complementary to this study, calculation spreadsheets are published that include the MEEUP EcoReports and input data.

There are also additional recommendations in chapter 8 for the appropriate putting into service of office lighting luminaires.

There is also a specific recommendation for additional research on a fast and easy market surveillance technique that is compatible with the suggested simple generic luminaire information requirements on light output and light distribution.

The scenarios in chapter 8 point out that implementing BAT requirements in 2010, would require in 2020 an estimated energy saving of 26.5 TWh electricity use compared to 34.7 TWh for BAU in 2020 and a total expenditure saving of 10 % for BAT compared to BAU. Also a worst case (WC) scenario has been calculated that assumes the use of halophosphate lamps in new calculated installations; the estimated energy in 2020 is 38.7 TWh (WC) with a total expenditure increase of 25 %. The reality is probably in between WC and the BAU scenario, especially when considering fluorescent lighting in non professional lighting applications (e.g. domestic). The impact on global warming potential (GWP) is almost proportional, wherein 34.7 TWh electricity use (Business as Usual scenario) is equivalent to 15.6 Mt CO₂ eq (GWP). The estimated energy consumption in 2005 is 26.5 TWh; this is the same value as for BAT in 2020. The first reason for this status quo is that the BAU scenario assumed a continuous increase of office space in EU27 and that from 2005 on, there was an important driver for specifying higher illuminance requirements for office lighting when the new EN 12464-1 (2004) standard was introduced. It should also be noted that not all energy saving is realised in 2020 with an implementing measure introduced in 2010 because the service life of luminaires was estimated on 20 years.

Also a miniBAT scenario is calculated that assumes no application of dimming in luminaires; this corresponds with 31.2 TWh in 2020. Dimming provides not only daylight related saving but also allows to fine tune illuminance to the real task requirements and can allow compensation for luminaire and lamp performance decrease over time.

Excluding inefficient halophosphate fluorescent lamps is also beneficial for reducing mercury in the environment. This could also be achieved by a revision of the exceptions for fluorescent lamps in the RoHS directive.

1 PRODUCT DEFINITION

The goal of this task is to define the product category and define the system boundaries of the ‘playing field’ for eco-design. It is important for a realistic definition of design options and improvement potential and it is also relevant in the context of technically defining any implementing legislation or voluntary measures (if any).

In this study, the product definition and classification is derived from existing European standards and official classification schemes. This is discussed in section 1.1 and the existing standards are described in section 1.2. The most broadly accepted definition for office lighting tasks and performance criteria can be found in the standard EN 12464-1 *Lighting of indoor work places*. ‘Lighting equipment parts’ comprising ‘luminaires’, ‘ballasts’ and ‘lamps’ are defined in standard EN 12665 *Light and lighting- Basic terms for specifying lighting requirements*. To our knowledge there exists no other specific definition for ‘office lighting equipment’ in standards or legislation. The main reason is that these products can also be used for other indoor lighting applications, e.g. the same luminaire or lamp can also be used in schools or hospitals. A Prodcom classification for office lighting luminaires exists, and also lamp categories are distinguished in Prodcom. All types of ballasts are subdivided into two Prodcom categories. Prodcom classification is very aggregate and therefore less useful for this specific office lighting study. Further and different segmentation compared to Prodcom is required. The approach in this study is therefore to use the task-based definition for office lighting ‘luminaires’ in line with the standard EN 12464-1 completed with a more detailed functional segmentation compliant with standard EN 13032 *Lighting applications — Measurement and presentation of photometric data of lamps and luminaires*. The main lamp type used in office lighting is the ‘fluorescent lamp’. For lamps and ballasts, a further segmentation is used in accordance with Directive 2000/55/EC and the compliant CELMA labelling system on ‘energy efficiency requirements for ballasts for fluorescent lighting’ that will be extended with a more detailed control system related segmentation.

1.1 Product category and performance assessment

1.1.1 System boundary and technical product definition

The following definition of office lighting equipment is derived from EN 12464-1:

Products for fixed installation for office work intended to “*enable people to perform visual tasks efficiently and accurately, adequate and appropriate*”.

An office lighting product system can more generally be considered a 'lighting equipment' as defined in standard EN 12665 *Light and lighting - Basic terms and criteria for specifying lighting requirements*, containing:

1. A “lamp” as “source made in order to produce an optical radiation, usually visible”;
2. A “ballast” as “device connected between the supply and one or more discharge lamps which serves mainly to limit the current of the lamp(s) to the required value”
Note that a ballast may also include means for transforming the supply voltage, correcting the power factor and, either alone or in combination with a starting device, provide the necessary conditions for starting the lamp(s);
3. A “luminaire” (Figure 1) as “apparatus which distributes, filters or transforms the light transmitted from one or more lamps and which includes, except the lamps themselves, all parts necessary for fixing and protecting the lamps and, where necessary, circuit auxiliaries together with the means for connecting the lamps to the electric supply”.



Figure 1: Typical office luminaires

In this study; ballasts, lamps and luminaires are considered the main products within office lighting equipment. It is important to notice that most luminaires, lamps and ballasts defined in this study are not exclusively used for office lighting. They could for example also be used in schools and hospitals and any other building that has areas for ‘office work’.

It is important for this eco-design study that the definition of office lighting covers products with similar characteristics in order to be able to derive meaningful conclusions regarding design options, improvement potential and finally potential policy options. The above definition of office lighting serves right for this study as according to the MEEuP Methodology Report (VHK, 2005) product groups that are functionally similar are envisaged. Consequently, a similar group of design options will apply to improve the environmental performance of these products. This study focuses on lighting equipment for ‘office work’ areas as they are functionally similar. Many other types of ‘office building’ indoor lighting can be thought of, such as lighting for circulation areas, toilets or the reception desk (Figure 2) located in office buildings. The luminaires and lamp types used for these “non-office work” building areas are not in the scope of the EuP study because they could have a different functionality (e.g. spot illumination at reception desk) and also can use other lamp types (e.g. halogen lamps). Products that fall out of the scope of this EuP office lighting study ‘may’ also benefit from the conclusions of this study, but it is suggested that these should also be studied and evaluated for their own functional application after the completion of this study.



Figure 2: Spot lights with halogen lamps at a reception desk (outside the scope of this study)

Following the previous product definition for office lighting, the products below are not in the scope of this study:

- In this study the product scope was limited to 'products for fixed installation for office work areas'. Because the standard EN 12464-1 specifies in the definition of 'task area' that 'for places where the size and/or location of the task area is unknown, the area where the task may occur shall be taken as the task area'. Therefore the task area and its requirements are 'fixed' with reference to the office rooms in the building and it can be deduced that therefore a 'fixed lighting installation' is required.
- 'Floor lamps' (Figure 3) are a special case. We assume that they can be used for functional office lighting as a special design case of suspended office luminaires when they are using the same technology. In this case, they are within the scope of the study. Please note that there are severe technical requirements for these 'floor lamps' when they are intended for functional office lighting (e.g. according to EN 12464-1). As a consequence they are seldom used for this purpose. In brief, the first requirement is that the task area must be clearly defined when the office construction project is setup. This implies a.o. that the office space should be fully equipped with 'fixed' furniture. The second requirement is that the appropriate electrical supply circuit must be installed to fulfil the electrical installation code requirements. Most electrical installation codes will require a separate electrical distribution line for the lighting circuit with its own fuse. An underlying reason for this requirement is that a short circuit in the electrical distribution line of the wall plugs (e.g. connected with PCs, ..) may not switch off light. Most of the 'floor lamps' on the market do not fulfil these requirements and consequently fall outside the scope of this study. Please note that many floor lamps are used in the domestic market and use another low cost technology (e.g. halogen lamps).

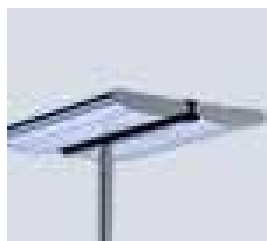

Figure 3 : Standard (floor) luminaire (Inside the scope of this study when they are a special design case of suspended office luminaires using the same technology)

- Displaceable table lamps (Figure 4) are considered complementary lighting, not intended for fulfilling the basic office illumination requirements and are outside the product boundary. This,

for the same reasons as mentioned before for 'floor lamps' and also because they are functionally different and use very different technology. The technology used in these office lamps is similar to table lamps for domestic lighting.



Figure 4 : Table lamp (outside the scope of this study)

- Emergency lighting (Figure 5) and signs in office buildings are not considered in this study. Their function is different from that of office lighting (“to enable people to perform visual tasks”). The required lighting levels for this application are very low and these products run mainly on rechargeable batteries (battery chargers are part of another eco-design study).

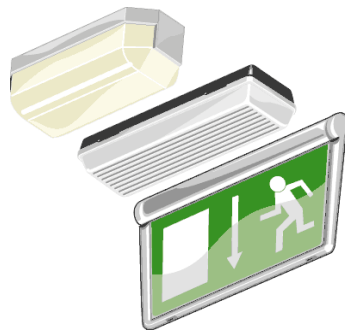

Figure 5 : Emergency lighting (outside the scope of this study)

- Building management lighting control system components (e.g. photocell, timers, switches, wiring, presence detectors, ..) (Figure 6) are not within the product scope of this study when they are not integrated into the luminaire. They will be regarded as part of the 'local infrastructure' (see chapter 3).



Figure 6: Building management lighting control system components (outside the scope of this study)

1.1.2 Prodcop classification of office luminaires, lamps and ballasts

In Eurostat's product-specific statistics for trade and production (the so-called Europroms¹-Prodcop² statistics) office lighting luminaires can be reported in two manners:

1. According to lamp technology
2. According to the material from which the luminaires are made.

1.1.2.1 Luminaires applicable in office lighting

The following 'luminaire' categories are defined in Prodcop:

First under heading 31.50.25 "Chandeliers and other electric ceiling or wall lighting lamps" 4 categories of office lighting (task lighting) luminaires can be distinguished, according to the lamp technology used.

- for incandescent lamps (31.50.25.63)
- for compact fluorescent lamps (31.50.25.65)
- for other fluorescent lamps (31.50.25.67)
- for other lamps (31.50.25.69)

Besides these relevant Prodcop headings, the lighting industry can obviously also report their products (office lighting luminaires) under the following CN-8³ headings:

- Electric lamps and lighting fittings, of plastic, of a kind used for tubular fluorescent lamps" (94.05.40.35)
- Electric lamps and lighting fittings (with the exception of those of plastic), of a kind used for tubular fluorescent lamps (94.05.40.95)
- Electric lamps and lighting fittings (with the exception of those of plastic) (94.05.40.99)

These 3 CN-8 categories form together with "Electric lamps and lighting fittings, of plastic, of a kind used for incandescent lamps. (94.05.40.31)", "Electric lamps and lighting fittings, of plastic (94.05.40.39)" and "Electric lamps and lighting fittings (with the exception of those of plastic), of a kind used for incandescent lamps (94.05.40.91)" the Prodcop heading 31.50.34.30 "Electric lamps and lighting fittings, of plastic and other materials, of a kind used for filament lamps and tubular fluorescent lamps".

1.1.2.2 Lamps applicable in office lighting

The for this office lighting study defined relevant 'lamps' are included in the following two Prodcop categories (please note that these lamps are also used in other applications):

- Fluorescent hot cathode discharge lamps, with double ended cap (excluding ultraviolet lamps⁴ (31.50.15.10)

¹ Europroms is the name given to published Prodcop data. It differs from Prodcop in that it combines production data from Prodcop with import and export data from the Foreign Trade database.

² Prodcop originates from the French "PRODUCTION COMMUNAUTAIRE"

³ Combined Nomenclature. This Combined Nomenclature contains the goods classification prescribed by the European Union for international trade statistics. The CN is an 8-digit classification consisting of a further specification of the 6-digit Harmonised System

- Fluorescent hot cathode discharge lamps (excluding ultraviolet lamps, with double ended cap)⁵ (31.50.15.30)

1.1.2.3 Ballasts applicable in office lighting

The defined 'ballasts' are included in two relevant categories (please note that these ballasts are also used with other lamp types and in other applications):

- Inductors for discharge lamps or tubes⁶ (31.10.50.13), corresponds to 'magnetic ballasts' as defined later in this chapter.
- Ballasts for discharge lamps or tubes (excluding inductors)⁷ (31.10.50.15), mainly including 'electronic ballasts' as defined later in this chapter.

1.1.3 Performance requirements for office lighting

Performance requirements for new office lighting installations are drawn up by CEN TC 169/WG 2 in the European standard EN 12464-1 (2002) called 'Lighting of work places- Part 1: Indoor work places'. This standard specifies requirements for lighting systems for most indoor work places and their associated areas in terms of quantity and quality of illumination. It is important to remark that in office lighting installations these performance requirements are most often met (only) through a combination of several luminaires. Note also that the installed base of office lighting does not necessarily meet these performance requirements. Determination of real-life performance versus standard performance is part of this study (see chapter 3).

The following terms and definitions are used:

- *Task area*: The partial area in the work place in which the visual task is carried out. For places where the size and/or location of the task area is unknown, the area where the task might occur shall be taken as the task area.
- *Immediate surrounding area*: A band width of at least 0,5 m surrounding the task area within the field of vision.
- *Maintained illuminance (\bar{E}_m)*: Value below which the average illuminance on the specified surface is not allowed to fall.
- *Glare* is the sensation produced by bright areas within the field of view and may be experienced either as discomfort glare or disability glare. Glare caused by reflections in specular surfaces is usually known as veiling reflections or reflected glare. In interior work places, discomfort glare may arise directly from bright luminaires or windows. If discomfort glare limits are met, disability glare is usually not a major problem. Discomfort glare limits are set with the CIE Unified Glare Rating (UGR-) tabular method: the lower the better.

⁴ Linear Fluorescent lamps (LFL)

⁵ Compact Fluorescent lamps (CFL)

⁶ The Prodcom category 'Inductors for discharge lamps or tubes' corresponds to ferromagnetic ballasts

⁷ The Prodcom category 'Ballasts for discharge lamps or tubes (excluding inductors)' corresponds to electronic ballasts

- *Colour rendering.* To provide an objective indication of the *colour rendering* properties of a light source the general colour rendering index R_a is used. The maximum value of R_a is 100. This figure decreases with decreasing colour rendering quality.

The relevant performance requirements for office work on task areas (Table 1) with 'high demand' are:

Table 1: Performance requirements for office work on task areas with “high demand” (Source: EN 12464-1)

Office work				
Type of interior, task or activity	\bar{E}_m	UGR _L	R_a	Remarks
Filing, copying, etc.	300	19	80	
Communication zones in work rooms	500	19	80	
Writing, typing, reading, data processing	500	19	80	DSE-work: see clause 4.11.
CAD work stations	500	19	80	DSE-work: see clause 4.11.
Conference and meeting rooms	500	19	80	Lighting should be controllable.
Reception desk	300	22	80	
Archives	200	25	80	

From this table it is clear that an illuminance between 300 and 500 lx is a default value for illuminance of the majority of office work activities.

Table 2 shows that the requirements for the immediate surrounding areas (area with width of at least 0.5 m surrounding the task area) are lower:

Table 2: Uniformities and relationship of illuminance of immediate surrounding areas to task area

Task illuminance	Illuminance of immediate surrounding areas
lx	lx
≥ 750	500
500	300
300	200
≤ 200	E_{task}
Uniformity: ≥ 0,7	Uniformity: ≥ 0,5

Because office desks and chairs are displaceable the “surrounding area” in an office room is usually low/limited, (e.g. mainly around the door entrance because this is the only place where evidently no office tasks (such as reading and data processing) can be performed).

Some studies have shown that the performance requirements for office lighting should be more than just the right amount of light for workplace tasks as defined in the EN 12464-1 standard.

These studies suggest that a close link exists between the quality of lighting on the one hand and productivity, motivation and well-being on the other hand.

This concept of lighting is also promoted by the lighting industry and is replacing the conventional (only functional) office lighting. The extent or pace in which this trend is evolving is discussed in chapter 2 on market analysis. With regard to standardization, no standards currently exist that define or measure these type of performance requirements.

1.1.4 Segmentation of luminaires

In order to have a realistic approach for the eco-design analysis in this study we will use the following functional classes for installed office luminaires according to light distribution. This segmentation is introduced in line with standards EN 13032-1&2 (Measurement and presentation of photometric data of lamps and luminaires). A sub-categorisation is used for 'ceiling mounted' and 'suspended' luminaires in line with these standards.

- **Category A 'Office lighting for areas with high illuminance requirements' (≥ 500 lux):**

- Subcategory A1 : Direct lighting (e.g.: ceiling mounted luminaires)

This subcategory is probably the most commonly known and installed office luminaire (see Figure 1). In most cases they have louvers or a special diffuser to prevent glare. Rectangular designs are also often used with 3 linear fluorescent lamps that fit in rectangular ceiling tiles.

- Subcategory A2 : Direct/indirect lighting (suspended, wall-mounted, floor-standing, other...luminaires)

This category of 'direct/indirect' lighting luminaires creates more indirect light by reflection on the ceiling and therefore reduces shading effects and needs another optic assessment.

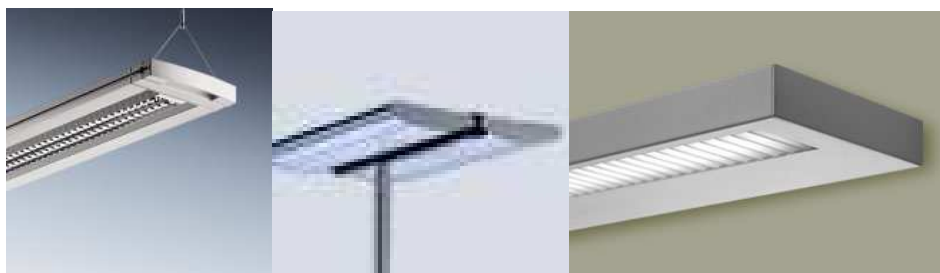

Figure 7 : Typical category A2 luminaire when intended for use in offices.

The following category is introduced in order to perform a more realistic market and installed base analysis.

- **Category B: 'Office building installed lighting for areas with medium and low illuminance requirements' (<500 lux) (outside the product boundary)**



Figure 8: Typical category B luminaire when intended for use in office corridors (outside the product boundary).

This category (Figure 8) is related to lighting installed in 'office buildings' but not in areas for 'office tasks'. This category will be treated in this study on a reduced scale in chapter 2 (analysis of installed lighting stock in office buildings) and in chapter 8 (improvement options).

- **Category C: 'Speciality mood and design office luminaires' (outside the product boundary):**

Finally category C is introduced because of an upcoming trend '*well being*'. These are luminaires with special functions -not only "*to enable people to perform visual tasks efficiently and accurately, adequate and appropriate*"(according to EN 16464-1)- but they have the additional functionality to influence circadian rhythm, mood and motivation of office workers (see chapter 3).

The performance of this additional 'well being' functionality is very difficult to quantify and no performance standards exist so far. Also, this category (Figure 9) is related to lighting installed in 'office buildings' generally, but is less relevant as lighting for performing 'office tasks'. For these reasons, this category is included in the scope of this project to the extent possible, mainly depending on data retrieval (chapter 2).

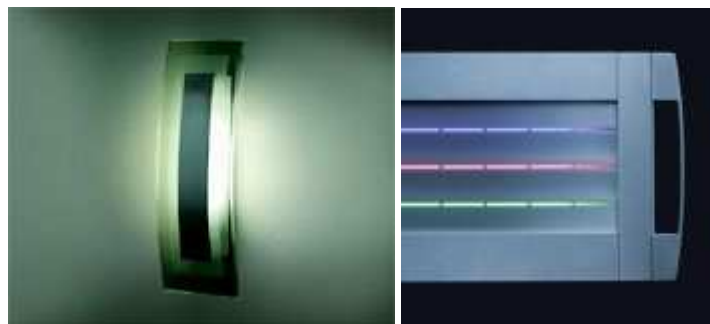

Figure 9: Category C examples: design luminaire (left) and RGB⁸ adaptable color luminaire (right)

⁸ Red Green Blue

Because of the upcoming trend it would be incorrect not to mention this category in this eco-design office lighting study. The eco-design options for this category are also more generic and could be formulated in chapter 8.

1.1.4.1 General luminaire performance specification parameters:

Each luminaire has its own specific characteristics. The important performance assessment parameters are (EN 12665(2002)):

- *Light Output Ratio (LOR)*: ratio of the total flux of the luminaire, measured under specified practical conditions with its own lamps and equipment, to the sum of the individual luminous fluxes of the same lamps when operated outside the luminaire with the same equipment, under specified conditions (see IEC 50 (845/CIE 17.4). Please note that lamp and ballast are generally measured at 25°C environmental temperature as standard conditions but that the lamp efficacy might increase when its temperature rises when installed in the luminaire; this is especially the case with T5 lamps as explained in chapter 3 and 4. This means that the lamp efficacy increases due to the temperature increase in the luminaire; this efficacy increase is generally included in the LOR.
- *Downward Light Output Ratio (DLOR)*: ratio of the downward flux of the luminaire, measured under specified practical conditions with its own lamps and equipment, to the sum of the individual luminous fluxes of the same lamps when operated outside the luminaire with the same equipment, under specified conditions (see IEC 50 (845/CIE 17.4).
- *Upward Light Output Ratio (ULOR)*: ratio of the upward flux of the luminaire, measured under specified practical conditions with its own lamps and equipment, to the sum of the individual luminous fluxes of the same lamps when operated outside the luminaire with the same equipment, under specified conditions (see IEC 50 (845/CIE 17.4).
- *Utilance (of an installation, for a reference surface)(U)*: ratio of the luminous flux received by the reference surface to the sum of the individual total fluxes of the luminaires of the installation (IEC 50/CIE 17.4).
- *Utilization Factor (of an installation, for a reference surface)(UF=UxLOR* ratio of the luminous flux received by the reference surface to the sum of the individual total fluxes of the lamps of the installation (IEC 50/CIE 17.4).

These parameters are defined in the context of this study:

- *Luminaire Efficacy Rating (LER)*: is the Light Output Ratio of the luminaire multiplied with the ballast efficiency and the lamp efficacy.

$$LER = LOR \times \eta_{ballast} \times \eta_{lamp}$$

with LOR in luminaire standard working conditions (ambient temperature 25°) and η_{lamp} at 25°C. Please note that η_{lamp} (lm/W) at 25°C is lower for T5 compared to T8 LFL lamps because T5 lamps are designed for higher operation temperatures.

- *Luminaire Efficacy Rating corrected (LERc)*: is the Light Output Ratio of the luminaire wherein the upward light flux fraction (UFF) is only accounted for 50 % in order to model indirect light as accurate as possible for functional lighting requirements.

$$LERc = LOR \times (DFF + 0.5UFF) \times \eta_{ballast} \times \eta_{lamp},$$

with LOR in luminaire standard working conditions (ambient temperature 25°) and η_{lamp} at 25°C.

1.1.4.2 General luminaire performance segmentation provided by the sector according to CIE 97 (2005)⁹ :

During the life of a lighting installation, the light available for the task progressively decreases due to accumulation of dirt on the surface and aging of the equipment. The rate of reduction is influenced by the equipment choice and the external and operating conditions. In lighting scheme design one must take into account this decrease by the use of a maintenance factor¹⁰ and one must plan suitable maintenance schedules to limit this decay. Lighting standard "ISO 8995/CIE S 008-2001 Lighting of Indoor Workplaces" Section 4.8, recommends a minimum maintenance factor. It states that "The lighting scheme should be designed with overall maintenance factor calculated for the selected lighting equipment, space environment and specified maintenance schedule". A high maintenance factor together with an effective maintenance programme promotes energy efficient design of lighting schemes and limits the installed lighting power requirements.

Luminaire segmentation:

There are 5 luminaire types defined in this standard:

- Bare lamp Batten
- Open Top Reflector (ventilated 'self cleaning')
- Closed Top Reflector (unventilated)
- Enclosed IP2X
- F-indirect upright

1.1.4.3 General luminaire performance segmentation provided by the sector according to DIN 5040:

This is a very detailed segmentation according to light distribution and is much more elaborated compared to category A1 and A2 as defined in this study. More info is included in the standard description in section 1.2.1.

1.1.5 Segmentation of ballasts

In offices almost exclusively fluorescent lamps are installed due to their low cost and high light output. For many applications fluorescent lamps give the highest efficiency and are aimed to replace incandescent or halogen lamps wherever possible. HID lamps also require a ballast but are not commonly used for office lighting as they are more expensive and the glare reduction requirements for office work are more difficult to meet.

The existing Directive 2000/55/EC on 'energy efficiency requirements for ballasts for fluorescent lighting' is applicable for office lighting and directly related to the EuP Directive. The purpose of this Ballast-Directive is to improve the efficiency of the lighting systems by limiting the ballast losses. For this purpose, CELMA developed a classification system that takes both the lamp and the ballast into account, which is compliant with the Ballast Directive. Ballasts are classified according to their Energy Efficiency Index (EEI).

⁹ Guide on the Maintenance of Indoor Electric Lighting Systems

¹⁰ The Luminaire Maintenance Factors (LMF) will be further explained and used in chapter 4

The ‘Energy Efficiency Index’ (EEI) of the ballast-lamp combination is defined as the corrected total input power of the lamp-ballast circuit. The grading consists of 7 classes of efficiency defined by a limiting value of total input power related to the corresponding ballast lumen factor (BLF). The label on the product will indicate the class defined through the Energy Efficiency Index.

The classes are A1, A2, A3, B1, B2, C and D (Figure 10).

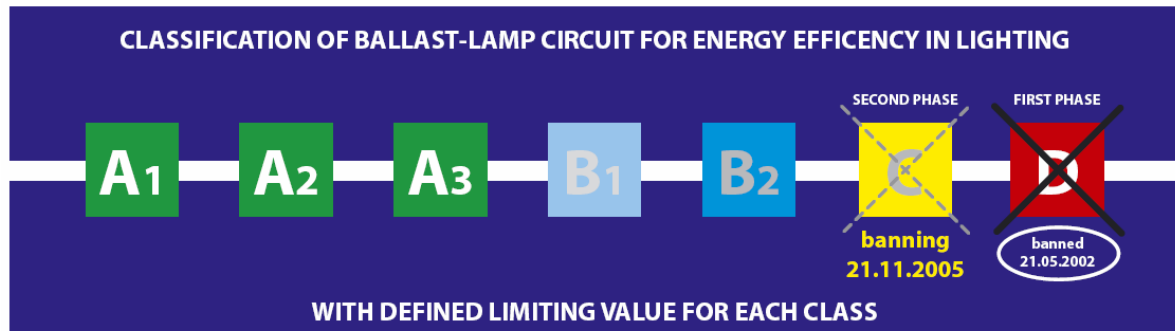

Figure 10 : Classification of ballast lamp circuit for energy efficiency in lighting.(Source: CELMA Ballast Guide)

Every class is defined by a limiting value of total input power when referenced with a BLF 1.00 for high frequency operated ballasts and 0.95 for magnetic ballasts. The Energy Efficiency Index (EEI) is compared to the corresponding table to obtain the relevant energy class of the ballast-lamp combination.

For fluorescent ballasts two main ballast technologies are distinguished that are linked to two series of CELMA ballast classes:

- 'Magnetic ballast' for fluorescent lamps (CELMA classes: D, C, B2, B1), generally containing up to 3 parts: ballast coil, igniters(optional), power factor capacitor. 'Magnetic ballasts are also called 'electromagnetic ballast' or 'conventional ballast' and operate the lamp at grid frequency 50 Hz (60 Hz). In the directive 2000/55/EC they are called 'ballast for lamp at 50 Hz'. In the directive there is no reference to technology.
- 'Electronic ballasts' for fluorescent lamps (CELMA classes: A1, A2, A3) operate the lamp at high Frequency (HF). These ballasts require a lower system power, mainly due to the 10% efficacy gain of the lamp, when it is operated at high frequencies. In the directive 2000/55/EC they are called 'ballast for lamp at HF (High Frequency)'. In the directive there is no reference to technology. Category A1 is intended for dimmable ballast able to operate the lamp at lower power. Electronic ballasts are also often called electronic control gear.
- For the purpose of this study CELMA class A1(dimming) ballasts will be further segmented according to the complementary control system when incorporated in the luminaire:
 - A1 daylight when equipped with a daylight responsive dimming control system.
 - A1 digital when a digital dimming control interface is available.
 - A1 digital+ when a digital dimming control interface is available and the maximum power can be fine tuned.
 - A1- fine tune when the maximum power can be fine tuned through a local setting.

- For the purpose of this study CELMA class A1, A2 and A3 ballasts will be further segmented according to the complementary presence detection control system when incorporated in the luminaire:
A1-3 presence for on/off switching interface with presence detection.
- Electronic power supply for solid state lamps (SSL) or LEDs will also be used in the context of the Best Not yet Available Technology in chapter 6.

As example for the CELMA ballast labelling system Table 3 contains the maximum input power requirements for linear T8 fluorescent ballast lamp circuits in Watt.

Table 3: Example for the CELMA ballast labelling system-Maximum input power requirements for linear T8 fluorescent ballast lamp circuits in Watt

Lamp type	Icos code	Lamp power		CLASS						
		50Hz	HF	A1	A2	A3	B1	B2	C	D
	FD-15-E-G13-26/450	15W	13.5W	9W	16W	18W	21W	23W	25W	> 25W
	FD-18-E-G13-26/600	18W	16W	10,5W	19W	21W	24W	26W	28W	> 28W
	FD-30-E-G13-26/900	30W	24W	16,5W	31W	33W	36W	38W	40W	> 40W
	FD-36-E-G13-26/1200	36W	32W	19W	36W	38W	41W	43W	45W	> 45W
	FD-38-E-G13-26/1047	38W	32W	20W	38W	40W	43W	45W	47W	> 47W
	FD-58-E-G13-26/1500	58W	50W	29,5W	55W	59W	64W	67W	70W	> 70W
	FD-70-E-G13-26/1800	70W	60W	36W	68W	72W	77W	80W	83W	> 83W

It is important to notice that operated on a conventional ballast, most lamp wattages need one ballast per lamp. The main exception is the 18W T8 lamp where 2 lamps can be operated at one 36 W ballast as tandem operation. Based on a different technology, electronic ballasts are often designed to operate several lamps at the same time which allows the use of only one ballast per luminaire, irrespective of the number of lamps.

1.1.5.1 General ballast performance specification parameters:

According to existing standards:

- *Ballast lumen factor (BLF)*: ratio of the luminous flux emitted by a reference lamp when operated with a particular production ballast (at the rated voltage of the ballast) to the luminous flux emitted by the same lamp when operated with its reference ballast (EN 12665 & CIE 121 (1996)).
- *Total input power of ballast-lamp circuit (P_{ballast})*: (see EN 50294).

Then next three parameters are defined in the context of this study:

- *Ballast efficiency (η_{ballast})*: ratio between the nominal lamp power (P_{lamp}) and the total input power of ballast-lamp circuit in standard conditions (see EN 50294).
Please note that CELMA standard conditions require BLF =0.95 for magnetic ballast circuits and BLF =1 for electronic ballast circuits. This means that it is assumed in this study that magnetic ballast circuits dim the lamp power to 0.95 and should be taken into account when interpreting CELMA ballast classes losses data (Table 3)..

- *Ballast Maintenance Factor (BMF)*: the ratio of the worst ballast efficiency at a given time in its life to the initial ballast efficiency in standard conditions at maximum power without lamp dimming (more information see chapter 3)
- *Ballast Gain Factor (BGF)*: the ratio of the average power consumption with lamp dimming to the maximum power consumption without lamp dimming (more information see chapter 3).

1.1.6 Segmentation of lamps

The main lamp categories (Figure 11) that are used in the office task area are:

- Linear fluorescent lamps (LFL),
- Compact fluorescent Lamps with non integrated ballast 'CFL-ni' in this study,

The lamp category that is used in this study when discussing Best Not yet Available Technology (see chapter 6) is:

- Light Emitting Diodes (LED's).



Figure 11: Examples of three important lamp types used in this study (left LFL, middle LED, right CFL)

Lamp categories that are used occasionally in office buildings (see chapter 2) are:

- Compact Fluorescent Lamps with integrated ballast ('CFL-i' in this study) or also commonly called 'energy-saving lamps' in the domestic market. Please note that this does not exclude that other lamp types can be 'energy-saving'.
- Tungsten Halogen Lamps or Halogen Lamps.
- Incandescent lamp or General Lighting Service lamp (GLS).







General remarks:

- LED's are at present rarely applied in office lighting for general illumination of the task area. They will be considered and discussed as Best Not yet Available Technique (BNAT) in chapter 6.
- Compact fluorescent lamps with integrated ballast (CFL-i) or so called 'energy saving lamps' are seldom used in offices and will be not treated in this study. The main reason is that light output is low compared to the requirements for office work. They are for example used in domestic applications.
- None of the above mentioned lamp categories are exclusively used for office lighting.

- In each category, several lamp power ratings, socket type (e.g. plug or screw), outer glass envelope, colour blend, .. exist.
- In this study simplified acronyms are used that are widely adopted in the field
- Lamp manufacturers use proprietary brand names and abbreviations in their catalogues.
- In order to provide compatibility between manufacturers brands, the ILCOS-code is created which defines exactly the lamp category, type, wattage, socket, dimensions,... This code is quite complicated and therefore seldom used by end users and in literature.

An overview of lamp types with acronyms and related standards is included in the following table.

Table 4: Overview of lamp types with acronyms and related standards

Acronym in this study	ILCOS-code	Other Literature and manufacturers	Full name	Related Standard
LFL 	FDH-35/30/1B-L/P-G5-16/1449, ...	TL, T8, T5, TL8, TL5, T5 HE, T5 HO, Lumilux, Master TL5, ..etc.	Linear Fluorescent Lamp	EN60081
CFL-ni 	FSD-24/L/30/1B-E-2G11 FSD-36/30/1B-E-2G11 etc.	CFL-ni, DULUX L SP, .PL-L, .Lynx-L, Biax etc.	Compact Fluorescent lamp (for use on external ballast)	EN 60901
CFL-i 	FBT-11/27/1B-220/240-E27 etc.	CFL-i, CFL, Dulux EL, PL-E, Mini-Lynx, Biax etc.	Compact Fluorescent lamp with integrated ballast or 'energy saving lamp'	EN 60901
Halogen Lamp 	HRGS/UB-20-12-GU5,3-51/10 etc.	Halopar, Brilliantline, Tru-Aim, Precise etc.	Tungsten Halogen Lamp or Halogen Lamp	EN 60357
GLS 		GLS	Incandescent lamp or General Lighting Service lamp	EN 60064
LED 		LED, OLED, SSL, ..	Light Emitting Diode or Solid State Lamp	

1.1.6.1 **General lamp performance specification parameters (according to EN 12665):**

Each lamp has his its own specific characteristics. The important performance assessment parameters are (EN 12665(2002)):

- rated luminous flux (Φ) unit: lumen (lm) (in standard conditions, see corresponding standard in table 6, important that this is measured after 100 h operation). Please note that LFL lamps are temperature-sensitive and that $\Phi@25^{\circ}\text{C}$ can differ from $\Phi@35^{\circ}\text{C}$; lamp nominal *luminous flux* is measured at 25°C according to EN 60081. More info is included in chapter 3.
- Lamp Survival Factor (LSF) (see also CIE 97): fraction of the total number of lamps which continue to operate at a given time under defined conditions and switching frequency.
- Lamp Lumen Maintenance Factor (LLMF) (see also CIE 97): ratio of the luminous flux emitted by the lamp at a given time in its life to the initial luminous flux.
- general colour rendering index (Ra): effect of a light source on the colour appearance of objects, compared with their colour appearance under a reference light source (CIE 13.3)
- The nominal lamp Power (P_{lamp}): the nominal power consumed by the lamp, unit Watt [W].
- luminous efficacy of a source (η_{lamp}): quotient luminous flux emitted by the power consumed by the source, unit (lm/W) ($=\Phi/P_{\text{lamp}}$). Please note that LFL lamps are temperature sensitive and that $\eta_{\text{lamp}}@25^{\circ}\text{C}$ can differ from $\eta_{\text{lamp}}@35^{\circ}\text{C}$. Lamp *lumen output* is always given at 25°C . Lamp *efficacy* in catalogues is given at optimum temperature i.e. for T8 LFL-lamps at 25°C and for T5-lamps at 35°C , according to EN 60081 to allow efficacy measurements at maximum efficacy. More info is included in chapter 3.
- Lamp Gain Factor (LGF): parameter defined in the context of this study as the ratio between lamp efficacy at 25°C and lamp efficacy at 35°C .
- Ballast Lumen Factor (BLF): ratio of the luminous flux emitted by a reference lamp when operated with a particular production ballast to the luminous flux emitted by the same lamp when operated with its reference ballast (CIE 17.4 / IEC 50 845)

1.1.6.2 **General lamp performance assessment provided by the sector according to CIE 97 (2005)¹¹ :**

During the life of a lighting installation, the light available for the task progressively decreases due to accumulation of dust and dirt on all exposed surfaces of lamps, luminaires and room surfaces and also due to the ageing of lamps and electrical equipment. The rate of reduction is influenced by the equipment choice and operating conditions. Lighting standard "ISO 8995/CIE S 008-2001 Lighting of Indoor Workplaces" Section 4.8 recommends a minimum maintenance factor. It states that "The lighting scheme should be designed with overall maintenance factor calculated for the selected lighting equipment, space environment and specified maintenance schedule". A high maintenance factor together with an effective maintenance programme promotes energy-efficient design of lighting schemes and limits the installed lighting power requirements.

Remark:

- The provided LLMF and LSF values are average sector values according to lamp type.

¹¹ Guide on the Maintenance of Indoor Electric Lighting Systems

- Individual lamp manufacturers can bring products with deviate LLMF and LSF on the market.

1.1.7 Functional unit for office lighting

Knowing the functional product segmentation used in this study for office lighting and the related performance requirements, we now further explain what is called the “functional unit” for office lighting. In standard 14040 on life cycle assessment (LCA) the functional unit is defined as “the quantified performance of a product system for use as a reference unit in life cycle assessment study”. The primary purpose of the functional unit in this study is to provide a calculation reference to which environmental impacts (such as energy use), costs,... can be related and to allow for comparison between functionally equal office lighting luminaires with and without options for improvement. Reducing the functional unit to light output alone would reduce the perspective mainly to parts (lamp and ballast) which cannot be individually assessed for office lighting alone.

The functional unit (FU) for office lighting in this study can be defined as:

“The maximum maintained useful luminous flux (lumen) from the luminaire according to the performance requirements for the office lighting task as set out in EN12464-1. ‘Maintained’ means that performance depreciation parameters are taken into account (e.g. the luminaire maintenance factor LMF, lamp lumen maintenance factor LLMF, ballast maintenance factor BMF, ...) and ‘useful’ means that only the luminous flux received by the office task area and immediate surrounding area is taken into account. ‘Maximum’ means that it is the luminous flux in non dimming conditions.”

Remarks:

- This approach allows comparing equal performing office lighting luminaires.
- In chapter 4 the corresponding formulas will be further elaborated but the relationship with illuminance is obvious when the space between the luminaires is known: illuminance (lx) = luminous flux (lm)/surface(m²)
- There is a link with installation requirements and also scenarios on substitution to energy-efficient lamp types or altering luminaire spacing can be simulated (system analysis). This link also allows to take into account and simulate that in lighting installations the performance requirements are often achieved by two or more light sources (mainly because the lighting uniformity requirements). It would be incomplete to look only at luminous flux because many luminaire optics have a negative impact on 'total luminous flux' and 'glare' but serve through a better light distribution with its anti-glare louvers to satisfy the installation requirements.
- This approach will allow to evaluate policy options at four levels in office lighting (installation, luminaire, ballast, lamp).
- An advantage of using this functional unit is that it can be directly linked to office floor space statistics expressed in m² and from which total EU energy consumption, environmental impacts and costs can be calculated. This is discussed in more detail in chapter 2 on economic and market analysis.

1.2 Lighting test standards or guidelines

This paragraph identifies and shortly describes the 'test standards or guidelines' that are related to the functional unit, resource use (energy, materials, ..), safety and other lighting product specific standards.

A “test standard or guideline” is defined in the context of this study as a standard or guideline that sets out a test method, but that does not indicate what result is required when performing that test. Therefore, strictly speaking, a test standard can be different from a “technical standard”. Especially 'technical standards' that are a specification against which all others may be measured are not discussed hereafter (e.g. the measurement of power, luminous flux, ..). In addition to “official” test standards, there are other sector specific procedures for product testing that are compiled by industry associations or other stakeholders for specific purposes included in this chapter. Also ongoing work for the development of new standards or guidelines is discussed together with recommendations for new ones.

The following references are made to:

- EN, European standard ratified by either CEN (European Committee for Standardization) or CENELEC (European Committee for Electro technical Standardization),
- IEC, International Electro technical Commission,
- CIE, International Commission on Illumination.

1.2.1 Standards and guidelines related to the functional unit

- *EN 13032-1 (2004), Lighting applications — Measurement and presentation of photometric data of lamps and luminaires — Part 1: Measurement and file format*

Scope:

This European Standard establishes general principles for the measurement of basic photometric data for lighting application purposes. It establishes the measurement criteria needed for the standardisation of basic photometric data and details of the CEN file format for electronic data transfer. This is part 1 of a multi part standard. Part 1 deals with the basic photometric measurement and file format. Other parts deal with lamps and luminaires data depending on the applications.

Status:

Recently adopted; manufacturers do not yet have data available according to this format.

Identified gaps:

In practice the sector often uses a sector specific file format (EULUMDAT, IES, ..).

- *EN 13032-2(2004): Light and lighting. Measurement and presentation of photometric data of lamps and luminaires. Part 2: Presentation of data for indoor and outdoor work places*

Scope:

This document specifies the required data for lamps and luminaires for the verification of conformity to the requirements of EN 12464-1 and prEN 12464-2. It also specifies data that are commonly used for lighting of indoor and outdoor work places. When these data are provided, they should conform to this document

When the room parameters, the luminaire data (according to EN 13032-1(2004)) are known this method allows to calculate the defined functional unit.

Status:

Recently adopted; manufacturers do not yet have data available according to this format.

- *DIN 5040-1(1976): 'Luminaires for general lighting applications'(Leuchten für Beleuchtungszwecke) Part 1:*

Scope:

This document specifies classes of luminaires according to light distribution characteristics for the upward (UFF) and downward light flux fraction (DFF) (Lichtverteilklasse, LVK).

Status:

German standard.

Each class has a specific letter (Table 5). For the definition of DFF & UFF please refer to EN 13032-1.

Table 5 Characteristic letter for luminaire light distribution classes.

Class	DFF	UFF
A	$0.9 \leq DFF \leq 1$	$0 \leq UFF \leq 0.1$
B	$0.6 \leq DFF < 0.9$	$0.1 < UFF \leq 0.4$
C	$0.4 \leq DFF < 0.6$	$0.4 < UFF \leq 0.6$
D	$0.1 \leq DFF < 0.4$	$0.6 < UFF \leq 0.9$
E	$0.9 \leq DFF < 0.1$	$0.9 < UFF \leq 1$

- *DIN 5040-2 (1976): 'Luminaires for general lighting applications'(Leuchten für Beleuchtungszwecke) Part 2:*

Scope:

This document specifies classes of luminaires according to light distribution characteristics for the direct illumination of the task area and the ceiling in a standard room (Lichtverteilklasse, LVK).

Status:

German standard.

Luminaires are characterized with two numbers (according to the direct light flux fraction on the task area (φ_{su}) and the direct flux fraction on the ceiling (φ_{so}) in a standard room (Figure 12)).

Please note that in Figure 12 'Leuchtenebene' means 'luminaire plane' and 'Bezugsebene' means 'task plane'.

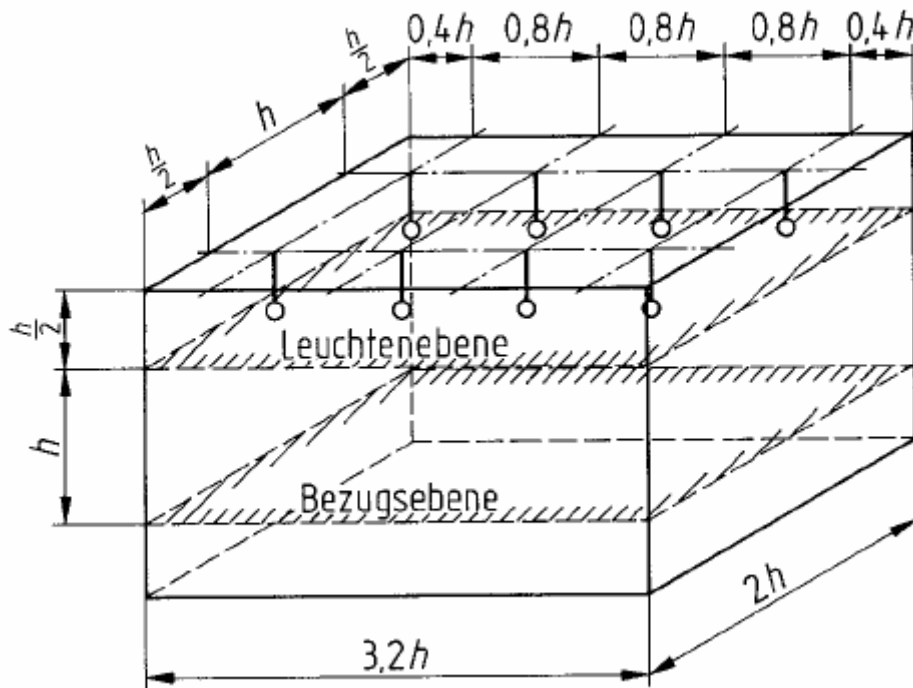

Figure 12 Standard room according to DIN 5040-2.

Table 6 Characteristic numbers for luminaire light distribution classes.

First characteristic number	φ_{su}	Second characteristic number	φ_{so}
1	$0\% < \varphi_{su} \leq 30\%$	1	$0\% < \varphi_{so} \leq 50\%$
2	$30\% < \varphi_{su} \leq 40\%$	2	$50\% < \varphi_{so} \leq 70\%$
3	$40\% < \varphi_{su} \leq 50\%$	3	$70\% < \varphi_{so} \leq 90\%$
4	$50\% < \varphi_{su} \leq 60\%$	4	$90\% < \varphi_{so} \leq 100\%$
5	$60\% < \varphi_{su} \leq 70\%$		
6	$70\% < \varphi_{su} \leq 100\%$		

- SN 520 380/4(2006): 'Electrical Energy in large Buildings' (Elektrische Energie im Hochbau):

Scope:

The purpose of this standard is rational use of electrical energy in new and renovated buildings. It contains amongst others minimum and best practice values for luminaires according to light distribution classes (DIN 5040) and lamp technology.

Status:

Swiss standard.

Reference values (are in Luminaire efficacy:

$$\eta_{\text{luminaire}} = \eta_{\text{lamp}} \times \eta_{\text{ballast}} \times \text{LOR}$$

Table 7 Minimum luminaire efficacy values according to light distribution

LVK class	example	beam	$\Phi_{su} + \Phi_{so}$	η luminaire LFL lamp [lm/W]	η luminaire CFL-i lamp [lm/W]	η luminaire HID lamp [lm/W]
A10-A32	ceiling mounted lum.	wide	100%	60	30	40
A40-A44	ceiling mounted lum.	medium	100%	55	35	40
A50-A80	ceiling mounted lum.	narrow	100%	55	35	40
B21-B22	suspended lum.	wide	75%	70	50	40
B31-B33	suspended lum.	normal	75%	65	50	40
B41-B63	suspended lum.	narrow	75%	60	50	40
C11-C33	suspended lum.	wide	50%	70	50	40
C42-C63	suspended lum.	normal	50%	70	50	40
D11-D63	floor lamp	all	25%	65	50	40
E02-E73	indirect lamp	wide	0%	55	50	40

Table 8 Best practice luminaire efficacy values according to light distribution

LVK class	example	beam	$\Phi_{su} + \Phi_{so}$	η luminaire LFL lamp [lm/W]	η luminaire CFL-i lamp [lm/W]	η luminaire HID lamp [lm/W]
A10-A32	ceiling mounted lum.	wide	100%	75	45	45
A40-A44	ceiling mounted lum.	medium	100%	70	50	50
A50-A80	ceiling mounted lum.	narrow	100%	65	50	60
B21-B22	suspended lum.	wide	75%	80	60	60
B31-B33	suspended lum.	normal	75%	80	60	60
B41-B63	suspended lum.	narrow	75%	75	60	60
C11-C33	suspended lum.	wide	50%	80	60	60
C42-C63	suspended lum.	normal	50%	75	60	60
D11-D63	floor lamp	all	25%	75	60	60
E02-E73	indirect lamp	wide	0%	70	60	60

- *NEMA LE 5-2001: 'Procedure for Determining Luminaire Efficacy Ratings for Fluorescent Luminaires'*

Scope:

Establishes a luminaire efficacy rating based on rated lumens per watt and organizes the types of luminaires into categories which will reasonably represent the characteristics of high volume luminaires. Serves as the basis for the National Voluntary Information and Rating Program required by the federal Energy Policy Act of 1992 (Public Law 102-486) for widely-used luminaires.

Status:

US free standard.

The codes for linear fluorescent products in this standard are:

- FL - Lensed
- FP - Parabolic Louver
- FW - Wraparound
- FS - Strip
- FI - Industrial

LER is a single figure that expresses 'luminaire efficacy', the luminaires light output divided by the input power. The formula is:

$LER = \text{Lamp lumens} \times \text{LOR} \times \text{Ballast factor} / \text{input power}$

- *Sector specific standard method: Professional light planning, calculation and visualisation software*

Sources (free downloads), e.g.:

<http://www.dialux.com>

<http://www.relux.biz>

<http://www.oxytech.it>

Scope:

This software is intended for light planning, calculation and visualization of indoor (and outdoor) lighting systems. Some software programs are free and some have the ability to import from and export to CAD programs and include photorealistic visualization with an integrated ray tracer.

Most software programs aim to take the latest standards into consideration as well as planning regulations and customs of the specific country.

Many large manufacturers provide free luminaire data to users.



Figure 13: Photorealistic visualization of office lighting

Identified gaps:

Calculation grid is not defined.

The compliance with the new EN 13032-1&2 standard data files is not yet implemented.

At this moment, different file formats for luminaire data are used, but most of the programmes (free download) cannot calculate with all formats. As there is actually a standardized format, the CEN-file format, it would be preferable that every programme could use this file format. Most common file formats are:

- EULUMDAT
- IES
- CIBSE
- CEN

1.2.2 Other test standards and guidelines not related to the functional unit

Other CEN documents concerning office lighting

- *EN 12464-1 (2004): 'Light and Lighting Lighting of indoor work places.'*

Scope:

This European standard specifies lighting requirements for indoor work places, which meet the needs for visual comfort and performance. All usual visual tasks are considered, including Display Screen Equipment (DSE).

This European standard does not specify lighting requirements with respect to the safety and health of workers at work and has not been prepared in the field of application of Article 137 of the EC treaty, although the lighting requirements, as specified in this standard, usually fulfil safety needs. Lighting requirements with respect to the safety and health of workers at work may be contained in Directives based on Article 137 of the EC treaty, in national legislation of member states implementing these directives or in other national legislation of member states.

This standard neither provides specific solutions, nor restricts the designers freedom from exploring new techniques nor restricts the use of innovative equipment.

This standard is not applicable for the lighting of outdoor work places and underground mining.

- *EN 12665 (2002): 'Light and lighting - Basic terms and criteria for specifying lighting requirements'*

Scope:

This standard defines basic terms for use in all lighting applications; specialist terms with limited applications are given in individual standards. This standard also sets out a framework for the specification of lighting requirements, giving details of aspects which shall be considered when setting those requirements.

- *prEN 15193 (2006): 'Energy performance of buildings - Energy requirements for lighting'*

Scope:

See section 1.3.1.3.

Non-limitative list of CENELEC documents concerning office lighting

- *EN 60598-1 : 'Luminaires Part 1 : General requirements and tests'*

Scope:

This Part 1 specifies general requirements for luminaires, incorporating electric light sources for operation from supply voltages up to 1 000 V. The requirements and related tests of this standard cover: classification, marking, mechanical construction and electrical construction.

- *EN 60598-2: 'Luminaires - Part 2: Particular requirements - Chapter 1: Fixed general purpose luminaires'.*

Scope:

This chapter of Part 2 of IEC Publication 598 specifies requirements for fixed general purpose luminaires for use with tungsten filament, tubular fluorescent and other discharge lamps on supply voltages not exceeding 1000 V. It is to be read in conjunction with those chapters of Part 1 to which reference is made.

- *EN 60598-2: 'Luminaires - Part 2: Particular requirements - Chapter 2: Recessed luminaires'.*

Scope:

Specifies requirements for recessed luminaires for use with tungsten filament, tubular fluorescent and other discharge lamps on supply voltages not exceeding 1000 V. This chapter does not cover air-handling luminaires.

Non-limitative list of CENELEC documents concerning lamps and ballasts

- *EN 60081 : 'Double-capped fluorescent lamps - Performance specifications'.*

Scope:

This International Standard specifies the performance requirements for double-capped fluorescent lamps for general lighting service.

The requirements of this standard relate only to type testing. Conditions of compliance, including methods of statistical assessment, are under consideration.

The following lamp types and modes of operation are included:

- a) lamps having preheated cathodes, designed for operation on a.c. mains frequencies with the use of a starter, and additionally operating on high frequency;
- b) lamps having preheated high-resistance cathodes, designed for operation on a.c. mains frequencies without the use of a starter (starter less), and additionally operating on high frequency;
- c) lamps having preheated low-resistance cathodes, designed for operation on a.c. mains frequencies without the use of a starter (starter less), and additionally operating on high frequency;
- d) lamps having preheated cathodes, designed for operation on high frequency;
- e) lamps having non-preheated cathodes, designed for operation on a.c. mains frequencies;
- f) lamps having non-preheated cathodes, designed for operation on high frequency.

For some of the requirements given in this standard, reference is made to "the relevant lamp data sheet". For some lamps these data sheets are contained in this standard. For other lamps, falling under the scope of this standard, the relevant data are supplied by the lamp manufacturer or responsible vendor.

- *EN 60901: ‘Single-capped fluorescent lamps – Performance specifications’.*

Scope:

This International Standard specifies the performance requirements for single-capped fluorescent lamps for general lighting service.

The requirements of this standard relate only to type testing. Conditions of compliance, including methods of statistical assessment, are under consideration.

The following lamp types and modes of operation with external ballasts are included:

- a) lamps operated with an internal means of starting, having preheated cathodes, for operation on a.c. mains frequencies;
- b) lamps operated with an external means of starting, having preheated cathodes, for operation on a.c. mains frequencies with the use of a starter, and additionally operating on high frequency;
- c) lamps operated with an external means of starting, having preheated cathodes, for operation on a.c. mains frequencies without the use of a starter (starter less), and additionally operating on high frequency;
- d) lamps operated with an external means of starting, having preheated cathodes, for operation on high frequency;
- e) lamps operated with an external means of starting, having non-preheated cathodes, for operation on high frequency.

- *EN 60921: ‘Ballasts for tubular fluorescent lamps – Performance requirements’.*

Scope:

This standard specifies performance requirements for ballasts, excluding resistance types, for use on a.c. supplies up to 1 000 V at 50 Hz or 60 Hz, associated with tubular fluorescent lamps with pre-heated cathodes operated with or without a starter or starting device and having rated wattages, dimensions and characteristics as specified in IEC 60081 and 60901. It applies to complete ballasts and their component parts such as resistors, transformers and capacitors. (It only applies to ferromagnetic ballasts; electronic ballasts are covered under IEC60929.)

- *EN 50294 : ‘Measurement Method of Total Input Power of Ballast-Lamp Circuits’.*

Scope:

This Standard gives the measurement method of the total input power for ballast-lamp circuits when operating with their associated fluorescent lamp(s). This standard applies to electrical ballast-lamp circuits comprised solely of the ballast and of the lamp(s). NOTE: Requirements for testing individual ballasts during production are not included. It specifies the measurement method for the total input power for all ballasts sold for domestic and normal commercial purposes operating with the following fluorescent lamps: linear lamps with power equal to or greater than 15 W; single ended (compact) lamps with power equal to or greater than 18 W; other general purpose lamps. This standard does not apply to: ballasts which form an integral part of the lamp; ballast-lamp circuits with capacitors connected in series; controllable

wire-wound magnetic ballasts; luminaires which rely on additional optical performance aspects.

The standard mandates that a ballast lumen factor be declared by the manufacturer - this has to be in the range 0.925 to 1.0 for magnetic ballasts and between 0.925 and 1.075 for electronic ballasts.

The test method for ferromagnetic and electronic ballasts is quite different and each is described below:

For magnetic ballasts, the test ballast is operated with a reference lamp. In addition the reference lamp is operated with a reference ballast. The total input power and the lamp power are measured for each circuit in parallel. Finally, the total input power for the test ballast/lamp circuit is corrected for the ballast lumen factor (BLF), this correction is done by measurement of the lamp power compared to the reference lamp. Please note that for the reference ballast a normalized ballast lumen factor of 0.95 has been chosen (this suggests that manufacturers tend to under-run lamps on average on magnetic ballasts). A similar method exists for electronic ballasts, in this case a reference ballast lumen factor of 1 is chosen. The total input power for the test ballast/lamp circuit is corrected for the ballast lumen factor (BLF), this correction is done by measurement of the lamp luminous flux compared to the reference lamp. Please note that for T5 fluorescent lamps no magnetic reference ballast exists, therefore an electronic reference ballast with known BLF needs to be obtained (Klinger (2006)), e.g. from a lamp manufacturer.

It is important to realize that in this approach the losses of the lamp filament preheating are accounted as ballast losses, because magnetic ballasts have switch-off lamp filament preheating enforced by the principle and also the most advanced T5 ballasts that are used as reference ballast do so.

- *EN 60927: 'Specification for auxiliaries for lamps. Starting devices (other than glow starters). Performance requirements'.*

Scope:

Specifies performance requirements for starting devices (starters and igniters) for tubular fluorescent and other discharge lamps for use on a.c. supplies up to 1 000 V at 50 Hz or 60 Hz which produce starting pulses not greater than 5 kV. Should be read in conjunction with IEC 60926.

- *EN 60929: 'AC-supplied electronic ballasts for tubular fluorescent lamps – Performance requirements'.*

Scope :

This International Standard specifies performance requirements for electronic ballasts for use on a.c. supplies up to 1 000 V at 50 Hz or 60 Hz with operating frequencies deviating from the supply frequency, associated with tubular fluorescent lamps as specified in IEC 60081 and IEC 60901 and other tubular fluorescent lamps for high frequency operation. (It only applies to electronic ballasts; ferromagnetic ballasts are covered under IEC60921.)

- *EN 61048 : ‘Auxiliaries for Lamps - Capacitors for Use in Tubular Fluorescent and Other Discharge Lamp Circuits - General and Safety Requirements’.*

Scope :

This International Standard states the requirements for both self-healing and non-self-healing continuously rated a.c. capacitors of up to and including 2,5 kVAr, and not less than 0,1 μ F, having a rated voltage not exceeding 1 000 V, which are intended for use in discharge lamp circuits operating at 50 Hz or 60 Hz and at altitudes up to 3000m.

- *EN 61049 : ‘Capacitors for Use in Tubular Fluorescent and Other Discharge Lamp Circuits Performance Requirements’.*

Scope :

Specifies the requirements for both self-healing and non-self-healing continuously rated a.c. capacitors of up to and including 2,5 kVAr, and not less than 0,1 F, having a rated voltage not exceeding 1 000 V, which are intended for use in discharge lamp circuits operating at 50 Hz or 60 Hz and at altitudes up to 3 000 m. Does not cover radio-interference suppressor capacitors, the requirements for which are given in IEC 60384-14. This publication supersedes IEC 60566.

- *IEC/TS 61231 : ‘International lamp coding system (ILCOS)’.*

Scope :

This technical specification gives the rules for the international lamp coding system and covers all lamp categories, excluding vehicle lamps. Coding for the main lamp types is specified and, for the others, will follow by amendments to this technical specification as appropriate.

The object of the international lamp coding system is:

- to improve communication about the different types of lamps;
- to help in discussions concerning interchangeability and compatibility of products;
- to create a closer relationship between international standards and manufacturers’ literature (for example the code could be given in future in the relevant parts of a standard);
- to enable correct replacements of lamps;
- to be used as a complementary marking on the luminaire;
- to replace national and regional coding systems.

The following non- limitative list summarises the CIE documents concerning office lighting (for a scope please consult CIE website on www.cie.co.at):

CIE 13.3-1995: Method of measuring and specifying colour rendering of light sources New edition (including Disk D008).

CIE 17.4-1987: International lighting vocabulary, 4th ed. (Joint publication IEC/CIE).

- CIE 19.21-1981: An analytic model for describing the influence of lighting parameters upon visual performance, 2nd ed., Vol.1.: Technical foundations.
- CIE 19.22-1981: An analytic model for describing the influence of lighting parameters upon visual performance, 2nd ed., Vol.2.: Summary and application guidelines.
- CIE 40-1978: Calculations for interior lighting: Basic method.
- CIE 52-1982: Calculations for interior lighting: Applied method.
- CIE 55-1983: Discomfort glare in the interior working environment.
- CIE 60-1984: Vision and the visual display unit work station.
- CIE 63-1984: The spectroradiometric measurement of light sources.
- CIE 69-1987: Methods of characterizing illuminance meters and luminance meters: Performance, characteristics and specifications.
- CIE 70-1987: The measurement of absolute luminous intensity distributions.
- CIE 77-1988: Electric light sources: State of the art – 1987.
- CIE 84-1989: Measurement of luminous flux.
- CIE 96-1992: Electric light sources - State of the art – 1991.
- CIE 97-2005 (2nd edition): Maintenance of indoor electric lighting systems
- CIE 102-1993: Recommended file format for electronic transfer of luminaire photometric data.
- CIE 117-1995: Discomfort glare in interior lighting.
- CIE 121-1996: The photometry and goniophotometry of luminaires.
- CIE 158-2004: Ocular lighting effects on human physiology and behaviour.

1.3 Existing legislation

1.3.1 Legislation and Agreements at European Community level

In this section the relevant legislation and EU voluntary agreements are described.

1.3.1.1 *Environmental Directives (RoHS, WEEE)*

- *Directive 2002/95/EC on Restriction of the use of certain Hazardous Substances in electrical and electronic equipment (RoHS)*

Scope:

The RoHS Directive stands for "the restriction of the use of certain hazardous substances in electrical and electronic equipment". This Directive bans the placing on the EU market, from 1 July 2006, of new electrical and electronic equipment containing lead, cadmium, mercury, hexavalent chromium, polybrominated biphenyl (PBB) and polybrominated diphenyl ether (PBDE) flame retardants.

Exemptions:

In annex, the exemptions from these requirements (a.o. for lamps) are listed:

- mercury in compact fluorescent lamps not exceeding 5mg per lamp

- mercury in straight fluorescent lamps for general purposes not exceeding

halophosphate	10mg
triphosphate with normal lifetime	5mg
triphosphate with long lifetime	8mg
- mercury in straight fluorescent lamps for special purposes
- mercury in other lamps not specifically mentioned in this annex
- lead in glass of fluorescent tubes.

There are no exemptions for luminaires and ballasts.

- *Directive 2002/96/EC on waste electrical and electronic equipment (WEEE)*

Scope:

The WEEE Directive aims to:

- reduce waste arising from electrical and electronic equipment (EEE);
- make producers of EEE responsible for the environmental impact of their products, especially when they become waste.
- encourage separate collection and subsequent treatment, reuse, recovery, recycling and sound environmental disposal of EEE .
- improve the environmental performance of all those involved during the lifecycle of EEE.

Exemptions:

In annex I A, all general categories of electric and electronic equipment concerned are mentioned; in annex I B, the subcategories with the exemptions are listed. In the subcategory of luminaires for fluorescent lamps, an exception is made for luminaires in households. Also filament bulbs (incandescent and halogen lamps) are exempt from this directive.

1.3.1.2 Minimum efficiency Directives

- *Directive 2000/55/EC on energy efficiency requirements for ballasts for fluorescent lighting*

Scope:

The purpose of this Directive is to improve the efficiency of the systems by limiting the ballast losses. For this purpose, CELMA developed a classification system that takes both parts of the system into account, the lamp and the ballast and that is compliant with the directive.

Exceptions for lamps: this directive is reviewed in detail in the preparatory study on office lighting.

- *Directive 98/11/EC on Energy labelling of household lamps*

Scope:

This Directive, which was published on 10th March 1998, applies the energy labelling requirements to household electric lamps supplied directly from the mains and to household fluorescent lamps. The Directive sets out the design and content of the label, as well as the colours that may be used.

The label must include the following information:

- the energy efficiency class of the lamp;
- the luminous flux of the lamp in lumens;
- the input power (wattage) of the lamp; and
- the average rated life of the lamp in hours.

The Directive also sets out how the energy efficiency class of a lamp will be determined.

Albeit these lamps are not commonly used for office lighting, this directive can be an example of lamp labelling for office lighting.

- *There is a 'European CFL QUALITY CHARTER'*
see '<http://energyefficiency.jrc.cec.eu.int/CFL/index.htm>'

Scope:

This is dedicated to self ballasted CFL lamps or CFL-I; as a consequence they are out of the scope of this study.

- *Directive 98/11/EC of 27 January 1998 implementing Council Directive 92/75/EEC with regard to energy labelling of household lamps*

Scope:

This Directive shall apply to household electric lamps supplied directly from the mains (filament and integral compact fluorescent lamps), and to household fluorescent lamps (including linear, and non-integral compact fluorescent lamps), even when marketed for non-household use.

1.3.1.3 Luminaire application related directives

- *Directive 2006/32/EC on energy end-use efficiency and energy services (repealing Council Directive 93/76/EEC)*

Scope:

According to the Directive the Member States shall adopt and aim to achieve an overall national indicative energy savings target of 9 % for the ninth year of application of the Directive, to be reached by way of energy services and other energy efficiency improvement measures. Member States shall take cost-effective, practicable and reasonable measures designed to contribute towards achieving this target.

- *Directive 2002/91/EC on the energy performance of buildings*

Scope:

The principal objectives of the Directive are:

- To promote the improvement of the energy performance of buildings within the EU through cost effective measures;
- To promote the convergence of building standards towards those of Member States which already have ambitious levels.

Measures include:

- Methodology for calculating the energy performance of buildings;

- Application of performance standards on new and existing buildings;
- Certification schemes for all buildings;
- Regular inspection and assessment of boilers/heating and cooling installations.

In the framework of this Directive the following relevant European standard is actually under development:

- *prEN 15193 (2006): 'Energy performance of buildings - Energy requirements for lighting'*.

Scope:

This European Standard specifies the calculation methodology for the evaluation of the amount of energy used for indoor lighting inside the building and provides a numeric indicator for lighting energy requirements used for certification purposes. This European Standard can be used for existing buildings and for the design of new or renovated buildings. It also provides reference schemes to base the targets for energy allocated for lighting usage. This European Standard also provides a methodology for the calculation of instantaneous lighting energy use for the estimation of the total energy performance of the building. Parasitic powers not included in the luminaire are excluded.

In this European Standard, the buildings are classified in the following categories: offices, education buildings, hospitals, hotels, restaurants, sports facilities, wholesale and retail services and manufacturing factories.

In some locations outside lighting may be fed with power from the building. This lighting may be used for illumination of the façade, open-air car park lighting, security lighting, garden lighting etc. These lighting systems may consume significant energy and if they are fed from the building, this load will not be included in the Lighting Energy Numeric Indicator or into the values used for heating and cooling load estimate. If metering of the lighting load is employed, these loads may be included in the measured lighting energy.

Status:

For voting.

1.3.1.4 Other product related directives

- *Electromagnetic Compatibility (EMC) Directive 2004/108/EEC*

Scope:

The Council Directive 2004/108/EEC of 15 December 2004 on the approximation of the laws of the Member States relating to electromagnetic compatibility (EMC Directive) governs on the one hand the electromagnetic emissions of this equipment in order to ensure that, in its intended use, such equipment does not disturb radio and telecommunication as well as other equipment. In the other the Directive also governs the immunity of such equipment to interference and seeks to ensure that this equipment is not disturbed by radio emissions normally present used as intended.

- *Low Voltage Directive (LVD) 73/23/EEC*

Scope:

The Low Voltage Directive (LVD) 73/23/EEC seeks to ensure that electrical equipment within certain voltage limits both provides a high level of protection for European citizens and enjoys a Single Market in the European Union. The Directive covers electrical equipment designed for use with a voltage rating of between 50 and 1000 V for alternating current and between 75 and 1500 V for direct current. It should be noted that these voltage ratings refer to the voltage of the electrical input or output, not to voltages that may appear inside the equipment. For most electrical equipment, the health aspects of emissions of Electromagnetic Fields are also under the domain of the Low Voltage Directive

1.3.2 Legislation at Member State level

This section deals with the subjects as above, but now for legislation that has been indicated as being relevant by the Member States.

No specific, country related legislation was found.

1.3.3 Third Country Legislation

This section again deals with the subjects as above, but now for legislation and measures in Third Countries (extra-EU) that have been indicated by stakeholders (NGOs , industry, consumers) as being relevant for the product group

Japan has a ‘Top Runner Programme’ for the efficiency of Energy using Products. For lighting, this programme imposes burdens for fluorescent lighting (see: http://www.eccj.or.jp/top_runner/).

In the next tables (Table 9 to Table 15) existing international legislation on labels and minimum performance related to fluorescent ballasts is included, they are equivalents of the existing EC legislation (source www.apec-esis.org):

Table 9: Mandatory Label for Ballasts (Electronic)

No.	Economy	Title
1.	Argentina	Programa de Calidad de Artefactos Electricos para el Hogar (PROCAEH) - Fluorescent Ballasts (22-12-2003)
2.	Colombia	Programa Colombiano de Normalizaci3n, Acreditaci3n, Certificaci3n y Etiquetado de Equipos de Uso Final de Energ3a (CONOCE) - Ballasts (2002)
3.	Costa Rica	Plaqueo Energetico - Ballasts (1996)
4.	El Salvador	Mandatory Standard (NSO) No. 29.39.01:03, Energy Efficiency of Double-Capped Fluorescent Lamps. Energy Performance and Labelling Requirements - Electronic Ballasts (2004)□
5.	Israel	Energy Label for Ballasts for Fluorescent Lamps - Israel (--)
6.	Philippines	Label for Electronic Ballasts For Fluorescent Lamps (--)
7.	Republic of Korea	Energy Efficiency Rating Labelling Program for Electronic Ballasts (01-07-1994)
8.	USA	EnergyGuide - Electronic Ballasts For Fluorescent Lamps (1994)

Table 10: Voluntary Label for Ballasts (Electronic)

No.	Economy	Title
1.	Canada	Environmental Choice Program (ECP) - Ballasts Electronic (1988)
2.	China	China Energy Conservation Product Certification - Electronic Ballasts For Fluorescent Lamps (--)
3.	Germany	Blue Angel (Umweltzeichen) - Ballasts (--)
4.	Hong Kong, China	The Hong Kong Voluntary Energy Efficiency Labelling Scheme for Electronic Ballasts (23-12-2004)
5.	New Zealand	Electronic Ballasts For Fluorescent Lamps - New Zealand (--)
6.	Republic of Korea	Certification of high energy efficiency appliance program for Electronic Ballasts (1997)
7.	Singapore	Green Labelling Scheme - Electronic Ballasts - Singapore (2000)
8.	Thailand	Green Label Scheme - Electronic Ballasts For Fluorescent Lamps (08-1994)
9.	Viet Nam	Label for Electronic Ballasts - Viet Nam (--)

Table 11: Minimum Energy Performance Standard - Mandatory for Ballasts (Electronic)

No.	Economy	Title
1.	Australia	AS/NZS 4783.2:2002 : Performance of electrical lighting equipment - Ballasts for fluorescent lamps - Energy labelling and minimum energy performance standard requirements (2003)
2.	Canada	Mandatory MEPS for Fluorescent Lamp Ballasts - Electronic (03-02-1995)
3.	China	GB 17896-1999 - The limited values of energy efficiency and evaluating values of energy conservation of ballasts for tubular fluorescent lamps (--)
4.	Colombia	Programme for the Rational and Efficient Use of Energy and Other Non-Conventional Energy Forms (Programa de Uso Racional y Eficiente de la energia y d (1998)
5.	Israel	MEPS for Ballasts for Fluorescent Lamps - Israel (--)
6.	New Zealand	NZHB 4783.2:2001 - Performance of electrical lighting equipment - Ballasts for fluorescent lamps Part2: Energy labelling and minimum energy performanc (01-02-2003)
7.	Republic of Korea	MEPS for Electronic Ballasts - Korea (01-07-1994)
8.	Thailand	Electronic Ballasts For Fluorescent Lamps - Thailand (10-02-2004)
9.	USA	10 CFR Part 430: Energy Conservation Program for Consumer Products: Electronic Ballasts For Fluorescent Lamps (--)
10.	Viet Nam	MEPS for Electronic Ballasts - Viet Nam (--)

Table 12: Mandatory Label for Ballasts (Magnetic)

No.	Economy	Title
1.	Australia	Labeling Program for Fluorescent Lamp Ballasts - Australia (--)
2.	Philippines	Label for Ballasts (Magnetic) - Philippines (2002)
3.	Republic of Korea	Energy Efficiency Rating Labelling Program for Magnetic Ballasts (01-07-1994)

Table 13: Voluntary Label for Ballasts (Magnetic)

No.	Economy	Title
1.	Brazil	Stamp Procel de Economia de Energia (Energy Efficiency Stamp) - Ballasts (1993)
2.	Brazil	INMETRO Brazillian Labeling Program (PBE) for Magnetic p/Sodium Reactors (--)
3.	Canada	Environmental Choice Program (ECP) - Ballasts Magnetic (1988)
4.	China	China Energy Conservation Product Certification - Magnetic Ballasts For Fluorescent Lamps (--)
5.	New Zealand	Magnetic Ballasts For Fluorescent Lamps - New Zealand (--)
6.	Republic of Korea	Certification of high energy efficiency appliance program for Magnetic Ballasts (1997)
7.	Singapore	Green Labelling Scheme - Magnetic Ballasts - Singapore (2000)
8.	Sri Lanka	Labels for Ballasts - Sri Lanka (--)
9.	Thailand	Energy Efficient Ballast Program - Magnetic Ballasts For Fluorescent Lamps (1998)

Table 14: Minimum Energy Performance Standard - Mandatory for Ballasts (Magnetic)

No.	Economy	Title
1.	Australia	AS/NZS 4783.2:2002 : Performance of electrical lighting equipment - Ballasts for fluorescent lamps - Energy labelling and minimum energy performance standard requirements - Ferromagnetic Ballasts (2003)
2.	Canada	Mandatory MEPS for Fluorescent Lamp Ballasts (03-02-1995)
3.	China	GB 17896-1999 - The limited values of energy efficiency and evaluating values of energy conservation of ballasts for tubular fluorescent lamps (Magnetic) (--)
4.	Costa Rica	National Energy Conservation Programme (Programa Nacional de Conservaci3n de Energ3a - PRONACE) - Ballasts (1996) □
5.	EU Member Countries	Directive 2000/55/EC of the European Parliament and of the Council (2004)
6.	Malaysia	Magnetic Ballasts For Fluorescent Lamps - Malaysia (1999)
7.	New Zealand	NZHB 4783.2:2001 - Performance of electrical lighting equipment - Ballasts for fluorescent lamps Part2: Energy labelling and minimum energy performanc (01-02-2003) □
8.	Philippines	PNS 12-3:1999: Lamp and related equipment: Electromagnetic ballasts - Energy standards and labelling requirements (2002)
9.	Republic of Korea	MEPS for Magnetic Ballasts - Korea (01-07-1994)
10.	Thailand	Magnetic Ballasts For Fluorescent Lamps - Thailand (10-02-2004)
11.	USA	10 CFR Part 430: Energy Conservation Program for Consumer Products: Fluorescent Lamp Ballasts Energy Conservation Standards (--)

There are various minimum standards and labelling programs applied worldwide for compact fluorescent lamps (CFL). Please note that they are almost without exception applicable to CFL-i or CFL with integrated ballasts and CFL-i is outside the scope of this study. CFL-i lamps are mainly used in domestic applications and also called 'energy saving lamps'.

Table 15: Minimum standards and labelling programs applied worldwide for CFL
(source www.apec-esis.org).

country	Minimum Standard	Labelling	National test standard	Reference test standard
Argentina		Yv(1)		
Australia	U(1)	Yv(1)		
Brazil	Ym(1)	Yv(2)	PROCEL 01 RESP/010-LUZ	
Canada	Ym(1)	Yv(1)	CAN/CSA-C 861-95	IES LM 66
Chile		Ym(1)	NCh 2695: 2002 NCh 3020: 2006	
China	Ym(1)	Yv(1)	GB/T 17263-2002 GB 19044-2003	
Colombia	Ym(1)		NTC 5101 NTC 5103 NTC 5102 NTC 5109	
Czech Republic		Yv(1)		
Ghana	Ym(1)	Ym(1)	GS 323:2003	
Hong Kong, China		Yv(1)	CIE 84-1989 IEC 60901 IEC 60969	
Hungary		Yv(1)		
Indonesia		Yv(1)		
Latvia		Yv(1)		
Mexico	Ym(1)	Yv(1)	NOM-017-ENER-1997	
New Zealand	U(1)			
Peru		Yv(1)		
Philippines	Ym(1)	Ym(1) Yv(1)	PNS 603-2-Amd.1:2001	
Poland		Yv(1)		
Republic of Korea	Ym(1)	Ym(1) Yv(1)	KS C 7621-99	
Singapore		Yv(1)	CIE 84-1989	
South Africa		Yv(1)		
Sri Lanka		Yv(1)	SLS 1225:2002	
Thailand	U(1)	Yv(2)	TIS 236-2533	IEC 60081
UK		Yv(1)		
USA	Ym(1)	Yv(1)	10 CFR Part 430 Subpart US Energy Star	IES LM 66
Viet Nam	U(1)	U(1)		

2 ECONOMIC AND MARKET ANALYSIS

The aim of the economic and market analysis is to place the product group office lighting within the total of EU industry and trade policy (section 2.1), to provide market and cost inputs for the EU-wide environmental impact of the product group (section 2.2), to provide insight in the latest market trends so as to indicate the place of possible eco-design measures in the context of the market-structures and ongoing trends in product design (section 2.3), and finally, to provide a practical data set of prices and rates to be used in the Life Cycle Cost calculation (LCC) (section 2.4).

2.1 Generic economic data

2.1.1 Data retrieval

“Generic economic data” gives an overview of production and trade data as reported by Eurostat. It places office lighting products within the total of EU industry and trade and also enables to check whether the product complies with the eligibility criterion of Art. 12., par. 2, sub a, of the EuP Directive.

To investigate the volume of sales and trade of a product group, it makes sense to rely on Eurostat’s product-specific statistics. For trade and production figures, these are the so-called Europroms¹²-Prodcom statistics.

Although we attempt to focus on the specific attributes of the office lighting market, much of our analysis could only be performed at the level of the EU total lighting market, as data were only available for few years and only in an aggregated form. In this report, our comparisons of imports, exports, production and apparent consumption¹³, give the reader a sense of the relative scales within the total lighting market. However, for numerous reasons¹⁴, these data comparisons should be considered only as approximations.

¹² Europroms is the name given to published Prodcom data. It differs from Prodcom in that it combines production data from Prodcom with import and export data from the Foreign Trade database.

¹³ Apparent consumption” is the estimation of the amount of each product consumed based on the amount produced plus the amount imported minus the amount exported. This is the rationale for combining Prodcom and Foreign Trade data in Europroms (Eurostat Data Shop Handbook, part 6.4.2 Europroms-Prodcom data, version 29/08/2003).

¹⁴ The general advantages, flaws and limitations of these official EU statistics are extensively discussed in i) the MEEUP Methodology Report and ii) the Eurostat data shop Handbook (part 6.4.2.) europroms-Prodcom data, version 29/08/2003.

2.1.2 Generic economic data lamps

A query was submitted on the website of Eurostat¹⁵ for extra-EU trade¹⁶ and production of the two most relevant lamp types applicable in office lighting: LFL and CFL lamps¹⁷. The query resulted in generic market data in physical volume and monetary units for several EU-25 Member States, for the years 1995 and 2000 until 2004. Adequate data is available for the years 2003 and 2004 to derive a figure on apparent consumption (total sales within the EU as result of production plus imports minus exports).

Results are presented in Figure 14 and Figure 15. Detailed figures on individual Member State level are presented in Table 121 and Table 122 in Annex B.

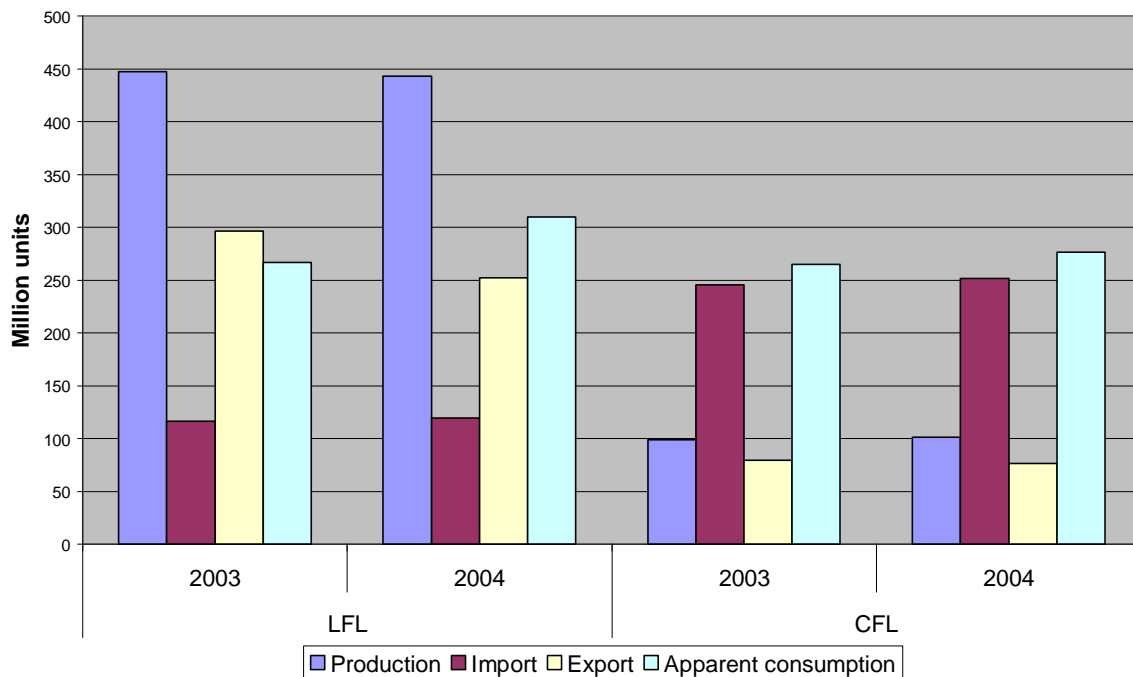

Figure 14: Volume of production, trade and sales of lamps for EU25

¹⁵ <http://epp.eurostat.ec.europa.eu> (Theme “Industry, trade and services”, last consulted 09/10/2006)

¹⁶ Note that for this EU25-study we are only interested in trade leaving and entering the EU25 as a whole region, so only the trade with Extra-EU is displayed.

¹⁷ See Table 118, Annex A for Prodcom category names and codes.

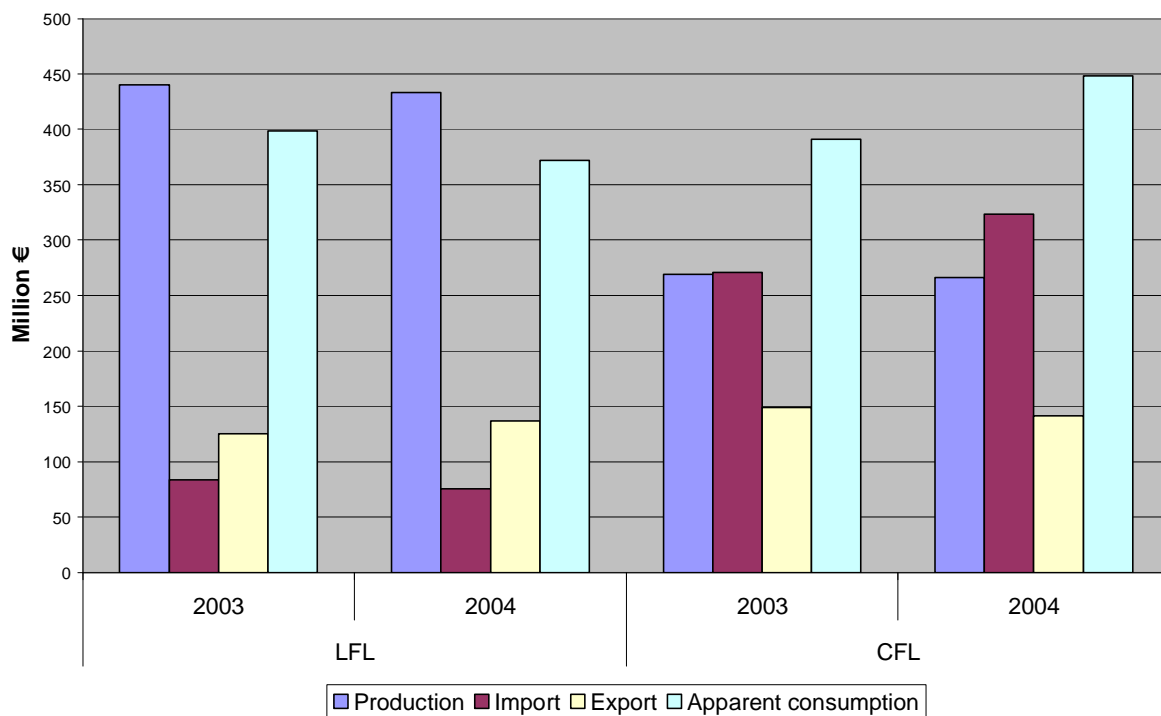

Figure 15: Value of production, trade and sales of lamps for EU25

Figure 14 shows that in 2003 the apparent consumption of LFL's and CFL's is in the same order of magnitude (around 265 mio units), while in 2004 the EU-25 sales of LFL's increases more substantially compared to that of CFL's.

In 2003-2004, the exported volume of LFL lamps is 2,1 to 2,5 times larger than the imported volume¹⁸. By consequence the apparent EU-25 consumption of this lamp type is remarkably smaller than its EU-25 production. For CFL lamps this is the other way around: the imported volume is 3,1 to 3,3 larger than the exported amount. The apparent consumption of CFL's is by consequence almost 2,7 times larger than the own EU-25 production.

While LFL's sold on the EU market are mainly those produced in the EU, CFL's are mainly imported.

In Table 123 (Annex C) export is expressed as the share of EU production, and import as a share of EU apparent consumption. From this figures it can be concluded that in 2001-2002 only a relative small fraction (16-17%) of the EU production of LFL's are exported, implying that the remainder (83-84%) are sold on the EU-25 market. The trend is however that the share of export as percentage of EU production increases (from 16% in 2001 to 32% in 2004). Imports represent only a minor part (12-13%) of EU apparent consumption of LFL's. The trend is that this share of import increases (from 12% in 2001 to 21% in 2004).

¹⁸ Note that this holds for the imports of all CFL lamps. According to ELC, imports are far stronger for CFL integrated lamps (with ballast), which are only used occasionally in offices, versus CFL pinbased lamps (non integrated or retrofit), which is one of the main lamp types used in offices. Unfortunately only aggregated import figures are available.

Compared to linear fluorescent lamps, the share of the EU production of CFL’s that are exported is much higher, ranging from 25% in 2001-2002 up to about 53-56% in 2003-2004 (see Table 124, Annex C). Imported CFL’s represent the majority of the EU apparent consumption and this share increases (57% in 2001 up to 73% in 2004).

One must bear in mind that these results hold for all LFL and CFL lamps (not only office lighting application). In section 2.2 the use of CFL versus LFL in office lighting is studied in more detail.

2.1.3 Generic economic data ballasts

For the two types of ballasts most frequently used in office lighting; ferromagnetic and electronic ballasts¹⁹, generic market data can be found in Eurostat both in physical volume and monetary units for several EU-25 Member States, for the years 1995 and 2000 until 2004. Adequate data is available for the years 2003 and 2004 to derive a figure on apparent consumption.

Results are presented in Figure 16 and Figure 17. Detailed figures on individual Member State level are presented in Table 125 and Table 126 in Annex D.

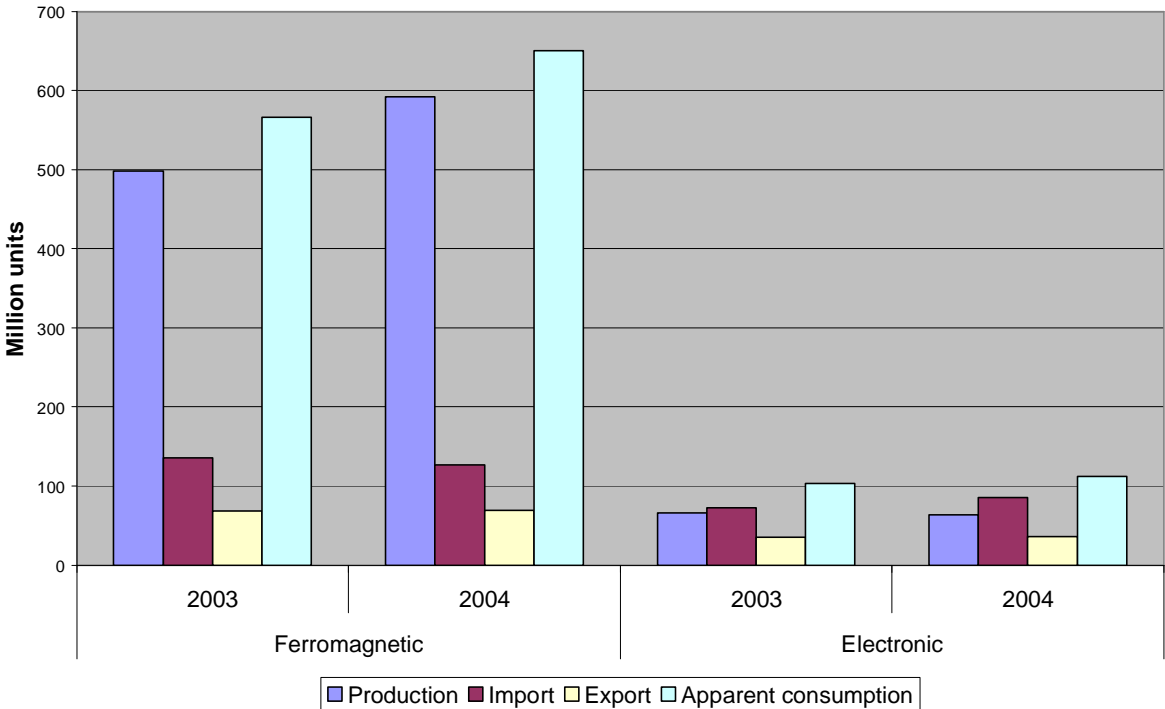

Figure 16: Volume of production, trade and sales of ballasts for EU25

¹⁹ See Table 119, Annex A for Prodcom category names and codes.

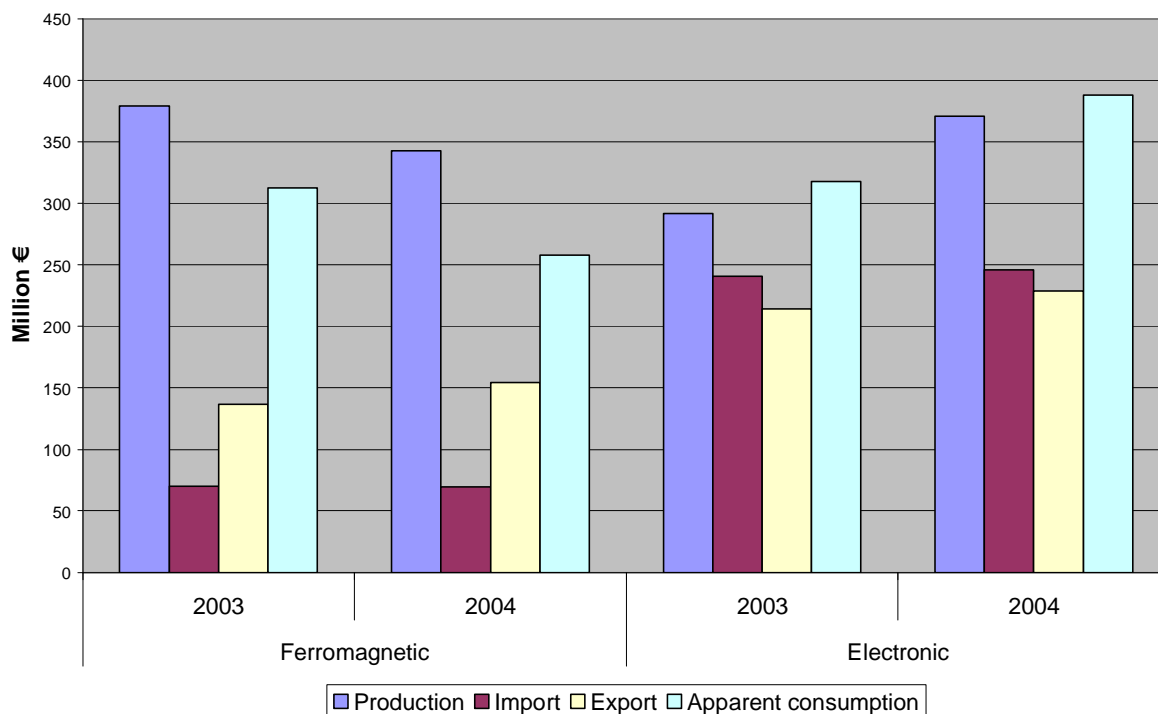

Figure 17: Value of production, trade and sales of ballasts for EU25

Figure 16 shows that the apparent consumption of ferromagnetic ballasts in volume is much higher compared to that of electronic ballasts, giving a ratio of 85% versus 15% for ferromagnetic and electronic ballasts respectively. Figure 17 shows that in terms of value however, sales of electronic ballasts is in the same order of magnitude (2003) or even higher (2004) compared to that of ferromagnetic ballasts.

While ferromagnetic ballasts sold in EU are mainly produced in the EU, electronic ballasts sold on the EU market are mainly imported.

Table 127 (see Annex E) shows that while in 2001 imports of ferromagnetic ballasts represented only 10% of EU apparent consumption, in 2004 approximately 1 out of 4 ferromagnetic ballasts consumed in Europe was imported. The relative share of exported ferromagnetic ballasts from EU production has increased strongly (26% in 2002 to 45% in 2004).

Table 128 (see Annex E) shows a slight different trend for electronic ballasts. In 2001 the share of EU production being exported was well balanced with the share sold on the EU-market (50/50%). After a sharp increase to about 75% of the share of export in 2003, this decreased again from 2003 onwards. The exact same trend is observed with regard to the share of imports (versus share produced in EU) that is apparently consumed on the EU market.

Again, as with the figures on lamps, one must bear in mind that these results hold for all ballasts (not only office lighting application). In section 2.2 the use of ferromagnetic versus electronic ballasts in office lighting is studied in more detail. As globally far more fluorescent

lamps are used than HID lamps in office lighting applications, fluorescent ballasts account for the bulk of the ballast market.

2.1.4 Generic economic data luminaires

As shown in the table below, Eurostat aggregates 4 types of office lighting luminaires according to lamp technology.

Table 16 : Office Lighting categories

PRODUCT GROUP	PRODCOM	DESCRIPTION
Office lighting	31502563	Office lighting (task lighting): for incandescent lamps
Office lighting	31502565	Office lighting (task lighting): for compact fluorescent lamps
Office lighting	31502567	Office lighting (task lighting): for other fluorescent lamps
Office lighting	31502569	Office lighting (task lighting): for other lamps

A search in Eurostat on these categories only resulted in little and fragmented data²⁰ on production. No data is available on trade. Table 17 presents the available figures for EU15 (no data for EU25).

At Member state level, figures are presented in Table 129 to Table 132 (see Annex F).

Table 17: Europroms results of 4 office lighting categories according to lamp technology: EU-15 production volume and value (1995, 2000-2002)

DESCRIPTION	Production (volume)				Production (value)			
	1995	2000	2001	2002	1995	2000	2001	2002
Office lighting (task lighting)								
For incandescent lamps	(1)	(1)	(1)	(1)	(1)	(1)	(1)	(1)
For CFL	(1)	2.897.468 (3)	551.772 (3)	1.328.013 (3)	(1)	56.667.559 (3)	34.106.869 (3)	77.319.486 (3)
For other fluorescent lamps (a.o. LFL)	(1)	17.421.169 (3)	2.108.722 (3)	5.881.166 (3)	(1)	251.838.855 (3)	85.191.105 (3)	341.748.259 (3)
For other lamps	962.485 (3)	(1)	(1)	(1)	10.313.148 (3)	(1)	(1)	(1)

According to Table 17, on average over the period 2000-2002; 1,6 million luminaires for CFL and 8,5 million luminaires for other fluorescent lamps (assuming mainly LFL) were produced in the EU-15. This results in a ratio of 15% CFL versus 85% LFL for about 10 million luminaires produced in the EU-15. No complementary official statistics are available as to indicate whether this ratio also applies for sales in the EU25. Extrapolating this EU-15 sales figure based on population results in 12 million luminaires as approximation for EU-25.

²⁰ For many Member States and some EU aggregates (for different years) the data are confidential (suppressed cells in Table 17, indicated with 1) or are estimated (suppressed cells in Table 17, indicated with 3).

2.1.5 Overview and conclusions

Table 18 presents a generic overview of the information on lamps and ballasts (detailed figures in Annex G).

Conclusions that can be drawn are that:

- For LFL's, the largest portion of EU consumption comes from EU production itself (compared to import).
- For CFL's and electronic ballasts this is the other way around; the portion of EU consumption from EU production is lower compared to the portion coming from import.
- For CFL's, ferromagnetic and electronic ballasts; far more CFL's are imported than exported. This is not true for LFL; the volume exported is about double the volume imported (2004).
- Imported products tend to be less expensive than the ones that are manufactured in the EU (dividing amount by value as indication of unit price, see Table 18).

Table 18: Overview of generic economic data for lamps and ballasts

EU-25 (2004)	Unit	Production	Export	Portion of EU production sold on EU market	Import	Apparent consumption
Lamp types applicable for office lighting						
<u>LFL</u>						
Volume	Millions	443	252	191	119	310
Value	Million €	433	137	296	76	372
Indicative unit price (calculated)	Euro	1	0,5		0,6	
<u>CFL</u>						
Volume	Millions	101	76	25	252	276
Value	Million €	266	142	125	324	448
Indicative unit price (calculated)	Euro	3	2		1	
Ballast types applicable for office lighting						
<u>Ferromagnetic ballasts</u>						
Volume	Millions	592	69	523	127	650
Value	Million €	342	154	188	70	258
Indicative unit price (calculated)	Euro	0,6	2		0,6	
<u>Electronic ballasts</u>						
Volume	Millions	63	37	27	86	112
Value	Million €	371	229	142	246	388
Indicative unit price (calculated)	Euro	6	6		3	

Indicative figures relating to the general lighting and office lighting market that can be derived from these official Eurostat statistics and that are useful for further tasks within this project (mainly chapter 5 on the determination of the office lighting Base cases and chapter 8 on scenario modelling) are:

1. Apparent consumption in volume of LFL's versus CFL's is approximately 50/50 % (see Figure 14);
2. Production in volume of office lighting luminaires "for CFL's" versus "for other fluorescent lamps" (assuming LFL) is approximately 15/85 % (see Table 17), indicating that the previous ratio is mainly valid for the general lighting market, but relatively more LFL compared to CFL is used in particular for the office lighting market;
3. Apparent consumption in volume of ferromagnetic versus electronic ballasts is approximately 85/15 % (see Figure 16);
4. On average (period 2000-2003, for EU-15) about 10 million luminaires for office lighting were produced in the EU-15 (see Table 17). Extrapolation based on population gives 12 million units as an indicative figure for EU-25.

Still, these figures are only to be considered as indicative because data availability is limited and only fragmented statistics are available at the aggregated level of lamps, ballasts (for all lighting applications) and luminaires (particular for office lighting).

For this reason we will have to estimate office lighting market data using other additional sources of information. This is elaborated in the following section 2.2.

2.2 Market and stock data

The purpose of this task is to provide market inputs for the definition of the Base case and the EU-wide environmental impact assessment of the product group 'office lighting' (chapters 5 and 8) and to provide market inputs for scenario analysis up to 2020 (chapter 8).

Market and stock data are required for the following time periods:

- 1990 (Kyoto reference)
- 2003-2005 (most recent real data)
- 2010-2012 (forecast, end of Kyoto phase 1)
- 2020-2020 (forecast, year in which all – or at least substantial share- new ecodesigns of today will be absorbed by the market)

The following gives an overview of the main market data that are required for this modelling, and that are discussed under this section 2.2. These data are essential to calculate EU-25 totals.

It could be said that the EU25-totals market parameters from Table 19:

- 1 to 11 change over the concerned time frame 1990-2020 (trend), but these remain unchanged regardless of what scenario is applied (business as usual, least life cycle cost, best applicable technology, ...);
- 12 to 16 change over the concerned time frame 1990-2020 (trend), but these are also variable and depending on the scenario that is applied.

Table 19: input data required for EU25 totals

Ref.	Table. inputs for EU25-Totals	Unit
1	Share Cellular Offices	% (of floor area)
2	Share Open plan (landscape) Offices	% (of floor area)
3	Share A1 direct lighting	% (of floor area)
4	Share A2 direct+indirect lighting	% (of floor area)
5	EU25 total office space	m2 floor area
6	Annual increase office space (before2005, after 2005)	%
7	Annual increase office space	m2 floor area
8	Share task area (of total office floor area)	% (of floor area)
9	Average \bar{E}_m (installed base)	Lx (for task area)
10	Average \bar{E}_m (new)	Lx (for task area)
11	Average luminaire life	Y
12	Share of existing luminaires with lamp type: (LFL vs CFL, amount of lamps per luminaire and wattage)	% / %
13	Share of new luminaires with lamp type: (LFL vs CFL, amount of lamps per luminaire and wattage)	% / %
14	Share of existing luminaires driven by ballasts: (EEI classes 'C & D' versus 'B1 and B2' versus 'A1, A2 and A3')	% / % / %
15	Share of new installed luminaires driven by ballasts (EEI classes 'C & D' versus 'B1 and B2' versus 'A1, A2 and A3')	% / % / %
16	Improvement Ratio Stock / New	

Other data related to the cost of goods, electricity and labour costs are discussed in section 2.3. Product parameters that are of more technical nature and that are relevant to determine improvement potential are discussed and listed under chapters 3 and 4.

2.2.1 Data retrieval

The following 4 approaches for retrieving data (complementary to section 2.1) were explored:

1. **Literature research:** various studies have been conducted on the energy use of office lighting for several Member States delivering useful data for this project on i.e. installed lighting configurations and related energy consumption, office floor area (useful for approach 4, estimating data on office floor area), etcetera. The most recent outline of the global trade in lamps and lighting products and the global market value and trends can be found in the recently published IEA Light's Labour's Lost (IEA, 2006).

2. **Consultation of ELC and CELMA:** a request for lamp and luminaire market data and any other relevant information was launched at the first stakeholder expert meeting (10/04/2006). ELC is the European Lamp Companies federation and CELMA is the federation representing 16 National Manufacturers Associations for Luminaires and Electro technical Parts for luminaires in the European Union. Mainly market data on sales of lamps, ballasts, market segments, and sales of luminaires was asked for. Since ELC only started compiling detailed sales statistics from 1999 onwards, sales data from 1990 until 1998 are less reliable (determined by linear projection from current data). Based on sales data and average luminaire lifetime, also the installed base can be calculated.
3. **Expert-inquiry:** a questionnaire was sent to experts from individual Member States and other lighting related organizations²¹. Experts from Belgium, Germany, Spain and the UK filled out this questionnaire. Despite this limited number of returns, the responses could confirm data from other sources, so should be considered as complementary.
4. **Calculated estimations based on office space :** data on office space (m²) and office space growth can be found in several studies and databases. The total installed base of office lighting can be derived when combining this floor area data with data on illuminance requirements for office lighting (lx) and the average performance of office lighting luminaires (m², or the area that can be lit per luminaire according to the illuminance requirements). Data on office area growth and illuminance requirements increase are used to make projections regarding the future installed base and annual sales of office lighting products (up to 2020).

In general²² there is a lack of good publicly available data on many of the key statistics pertaining to the energy use of lighting in the commercial sector. This is remarkable when one considers how much energy is used in providing this service. Regrettably, the majority of OECD countries have failed to establish and maintain reliable data-sets on this topic despite the high public-policy interest in economising lighting energy use (IEA, 2006). As a result many assumptions have to be made to try to characterise current practice, and a mixture of data-sources, have been applied to make the existing estimates.

2.2.2 Current sales lamps

The objective is to determine the actual sales as reliably as possible for the office lighting product categories as defined in section 1.1, among others lamps (and mainly LFL and CFL used for office lighting, see section 2.1), for the latest full year for which data could be retrieved.

A request for market data and any other relevant information was launched at the first stakeholder expert meeting on 10/04/2006 at EC DG TREN. Industry associations for luminaires and components (CELMA) and lamps (ELC) have set up a task force to supply this information.

²¹ Questionnaire can be downloaded from the EuP4light project website (www.eup4ligh.net)

²² some European countries aside

ELC provided sales figures for all types of lamps for the period 1999-2004²³. These ELC sales figures were then rescaled to EU-25 market based on population²⁴. Further input was asked from the lamp industry experts (through ELC) to provide, per different lamp type, reliable estimates on the share of these sales figures intended for application in office lighting. Unfortunately no such data are available and by consequence we needed to make some assumptions.

Figure 18 and Table 20 give an overview of the total lamp sales in EU-25 from 1999 to 2004 (detailed data can be found in Table 133 in Annex H).

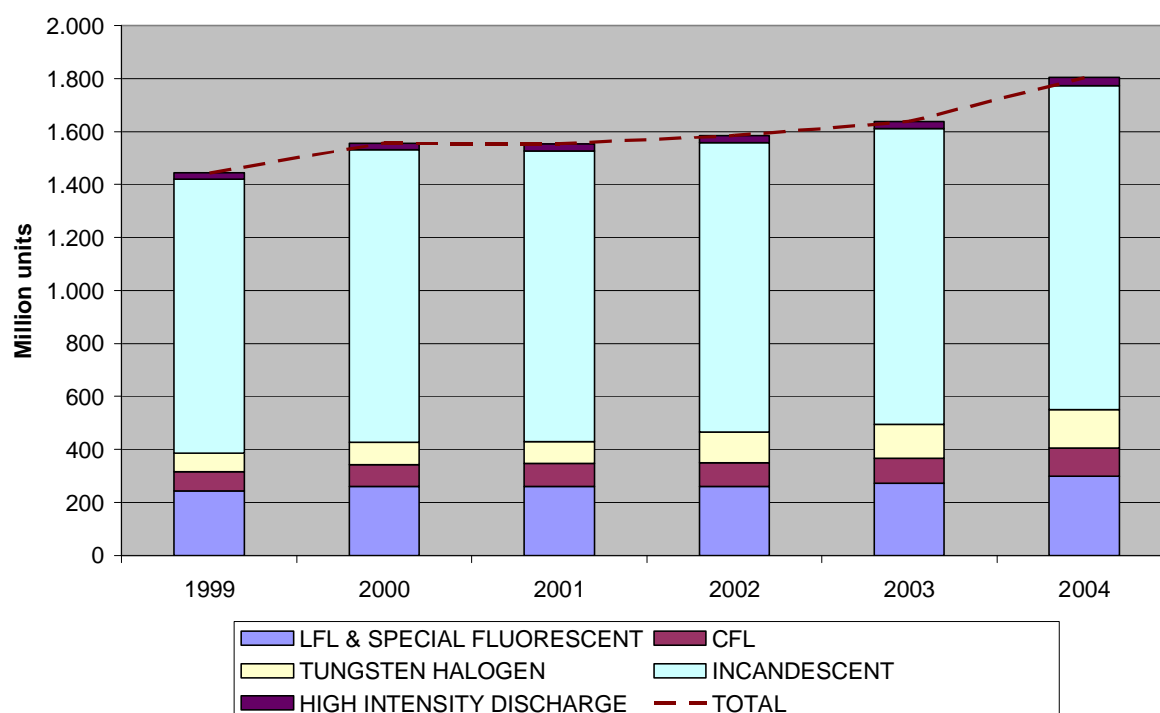

Figure 18: Volume of EU-25 lamp sales, 1999-2004

Table 20: Volume of EU-25 lamp sales, 1999-2004

Lamp Type (million units)	1999	2000	2001	2002	2003	2004	2004 (%)	annual growth
LFL & SPECIAL FLUORESCENT	242	261	259	260	271	298	16%	4,2%
CFL	73	81	87	90	95	108	6%	8,3%
TUNGSTEN HALOGEN	71	85	84	117	128	143	8%	15,1%
INCANDESCENT	1.035	1.104	1.097	1.092	1.116	1.225	68%	3,4%
HIGH INTENSITY DISCHARGE	23	25	26	27	28	30	2%	5,1%
TOTAL	1.444	1.556	1.553	1.585	1.638	1.804	100%	4,5%

²³ EU25 + Switzerland, Norway, Bulgaria, Romania, Turkey, Belarus, Russian federation, Ukraine, Yugoslavia.

²⁴ EU25 population represented 58,5% of the total population of the countries to which the original ELC sales data related.

As mentioned earlier in section 1.1.6, indicated by generic economic data in section 2.1, and the expert-inquiry (see Table 22 later in this section) the two main lamp types used in office lighting are the linear fluorescent lamps (LFL's) and the non-integrated, or retrofit-, compact fluorescent lamps (CFL's). To a much lesser extent halogen and incandescent lamps are used for lighting office task areas (these are mainly used for sanitary areas, corridors, entrance halls, etc...). Table 20 indicates that for 2004 (most recent available data) LFL's represent a market share of 16% of the total lamp sales and CFL's 6%. Annual increase is 4,2% for LFL's and 8,3% for CFL's.

Table 21, Figure 19 and Figure 20 show the evolution of the penetration rate of LFL and CFL in the EU-25. This is the relative market share of a technology as a percentage of new purchases (i.e., annual sales). These annual sales both comprise new lamp purchases for new luminaires as for lamp replacement within the installed base of (office) lighting luminaires.

“Linear fluorescent and Special fluorescent” are further subdivided into the following types:

- a. T12
- b. T8 Halo phosphor
- c. T8 tri-phosphor
- d. T5 new (14-80W)
- e. All others (including T5 old types 4-13W and Special)

Table 21: Volume of EU-25 LFL and CFL lamp sales, 1999-2004

	1999	2000	2001	2002	2003	2004	2004(%)	annual growth
	000's							
LFL								
T12	24	26	20	17	16	14	5%	-10,1%
T8 Halophosphor	116	126	126	127	135	150	50%	5,2%
T8 tri-phosphor	67	72	74	76	79	88	30%	5,7%
T5 new (14 - 80w)	8	9	9	9	10	12	4%	8,0%
Others	27	29	31	30	31	33	11%	4,4%
LFL TOTAL	242	261	259	260	271	298	100%	4,2%
CFL								
(a) Retrofit	32	35	39	41	44	52	48%	10,1%
(b) Non-Retrofit	40	46	47	49	51	56	52%	6,8%
CFL TOTAL	73	81	87	90	95	108	100%	8,3%

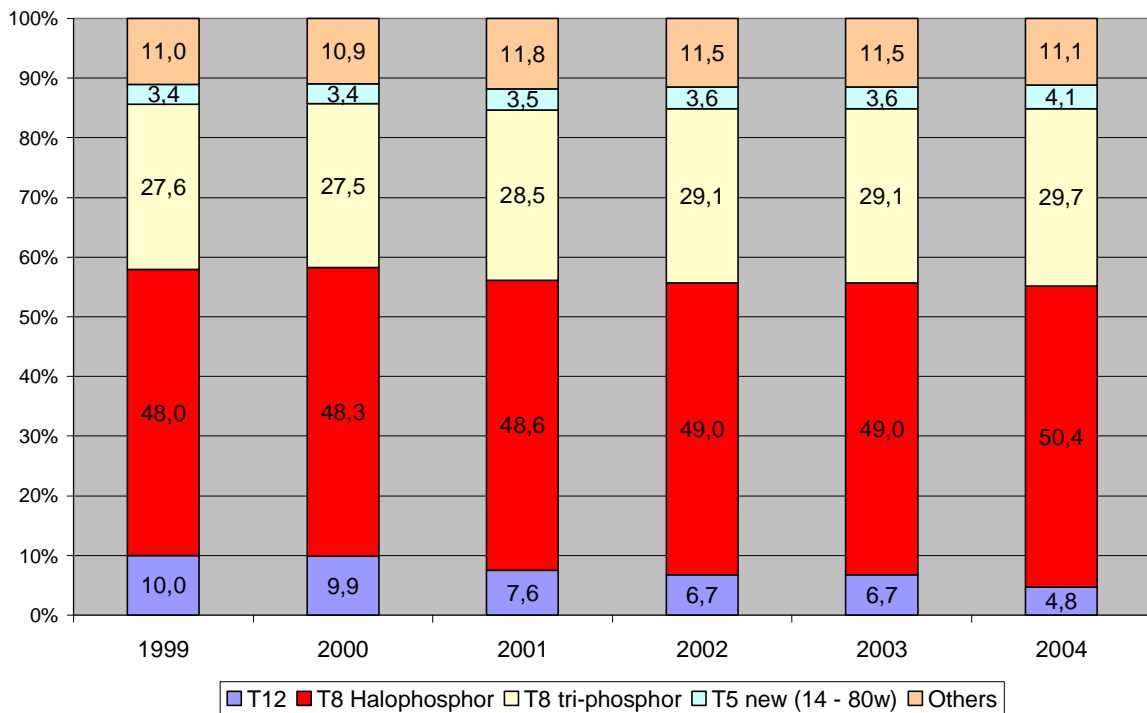

Figure 19: Evolution of penetration rate of LFL in EU-25, 1999-2004

In Europe the T8 Halophosphor lamps make up about half of the total LFL sales at present. Note that depending on the relative share of low-efficacy T12 lamps compared to the high-efficacy T5; the average efficiency of the aggregated LFL category can vary considerably between national markets.

Table 21 shows that while the (halo- and triphosphor) T8 lamps grow at a somewhat faster pace (5,2% and 5,7% annually between 1999-2004) as the total LFL sales (4,2%), T5 new lamps display a much stronger growth rate (8% annually). T12 lamp sales exhibit an annual decline of -10% over the same period.

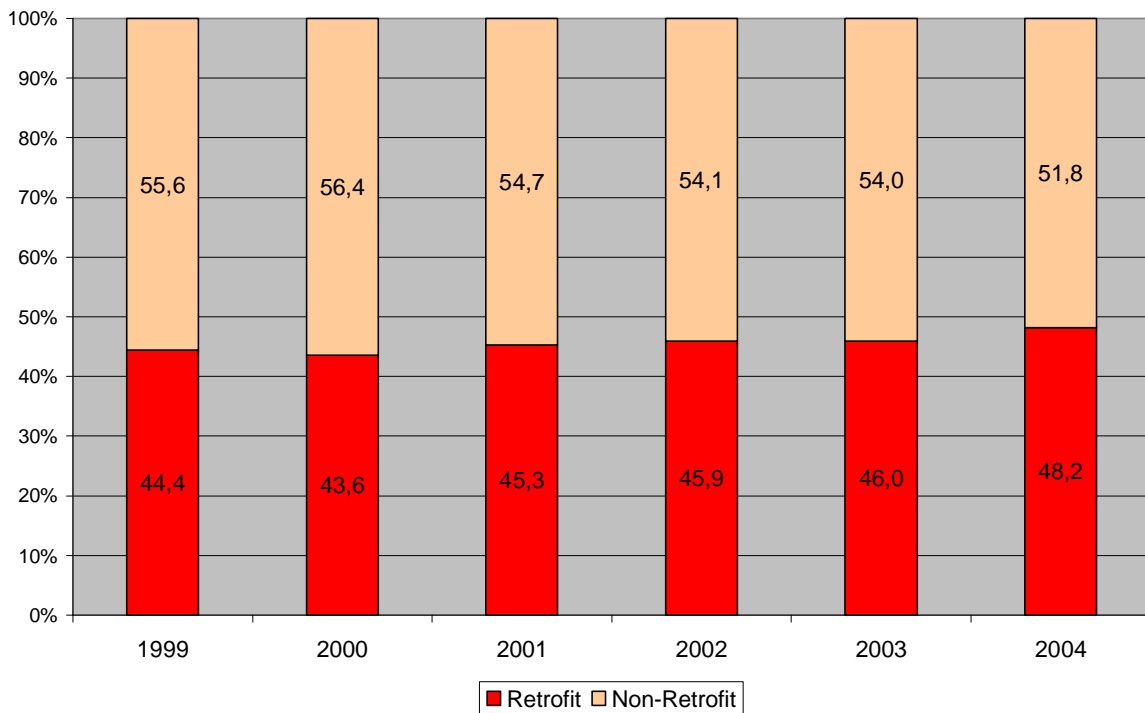

Figure 20: Evolution of penetration rate of CFL in EU-25, 1999-2004

Most recent sales data for 2004 indicate that the share of non-integrated or retrofit CFL's versus integrated CFL's are almost fully balanced: i.e. 48% versus 52%. This corresponds with an absolute sales number of 52 million retrofit CFL's in EU-25 in 2004.

Table 21 shows that the CFL retrofit lamps (relevant for office lighting) grow at a much faster pace (10% annually) compared to the integrated or non-retrofit CFL variant (7% annually in period 1999 to 2004).

Comparison of the apparent consumption figures retrieved from Eurostat (see section 2.1) with the ELC sales figures rescaled to EU25 shows that Eurostat consumption data are little higher for LFL's (4% in 2004) and significantly higher for CFL's (155% in 2004). That significant differences between actual consumption data and the (calculated) apparent consumption from official statistics may occur is extensively discussed in the MEEuP report (VHK, 2005). One of the possible explanations for the large difference in market figures on CFL's could be a substantial import from non ELC-members (e.g. from Asia).

The expert inquiry gave indicative figures for the distribution of lamp types used for new office lighting installations. LFL's represent the largest share with 80-90%. CFL's represent a share of 10-20%.

Table 22: Lamp types used for new office lighting, in particular task area (Expert Inquiry)

	Belgium	Germany	Spain
Fluorescent lamps	95%	100%	85%
CFL	16%	10%	20%
T8 LFL	52%	45%	50%
T5 LFL	32%	45%	30%
Other types	5%	0%	15%

By combining the ELC sales data for LFL and CFL lamps (Table 21) with CELMA sales data on ballasts (Table 24) it can be derived that about half of lamp sales are for new luminaires.

Table 23: Derivation of lamp sales for new luminaires

	2000		2004	
	(000's)	%	(000's)	%
<i>ELC (lamps)</i>				
LFL (and special FL)	261.303		297.639	
CFL	81.119		108.286	
Total fluorescent sales (a)	342.421		405.925	
<i>CELMA (ballasts)</i>				
Estimated total number of lamps installed in new luminaires	178.000	52	207.000	51
<i>Difference: a-b</i>				

2.2.3 Current sales office luminaires

CELMA can not provide statistics for luminaires due to the specific structure of the lighting luminaires market: many companies in different countries with different statistical reporting systems. No reliable EU-25 data exist.

From Eurostat statistics we could neither retrieve a reliable apparent consumption figure, only an indicative EU-25 production of 12 million office luminaires (see section 2.1.4).

For this study, mainly indirect estimates of stock and sales of luminaires will be made, based on office surface data and illuminance requirements (see section 2.2.1, data retrieval approach 4). This is further elaborated in section 2.2.7.

2.2.4 Current sales ballasts

In the following Table 24, an overview is given of ballast market data for 2000 and 2005 provided by CELMA²⁵. Ballast sales in volume are presented in two ways: as the number of lamps driven by ballasts and as the actual number of ballasts. This distinction is made because

²⁵ Available at http://www.celma.org/pdf_files/CELMA_Ballast_Guide_2005.pdf and updated with figures for 2005 (also received from CELMA).

while ferromagnetic ballasts need one ballast per lamp²⁶, electronic ballasts can operate multiple lamps. Based on market behaviour (single, twin and multilamp luminaires), a Lighting Point Index (LPI) of 1,1 is valid for magnetic ballasts and 1,7 for electronic ballasts (meaning that on average 1,7 lamps are driven by one electronic ballast). The voluntary classification scheme used by CELMA for ballasts (types A1 to D) is discussed in section 1.1.5. This classifications scheme together with the minimum efficiency requirements for ballasts, which came into effect in 2002, should result in a gradual market transformation. According to the European Directive 2000/55/EC class D ballasts should be phased out since 2002 and class C ballasts since 21/11/2005.

Table 24: Number of new installed lamps driven by different types of ballast and derived ballast sales in 2000-2005

Ballast type	2000					2005					Annual growth	
	Actual ballast sales			New installed lamps driven by		Actual ballast sales			New installed lamps driven by		Actual ballast sales	New installed lamps driven
EEI Class	Mln.	%		Mln.	%	Mln.	%		Mln.	%	%	
C, D	105	71	83	115,5	76	77	46	74	85	65	-6,0	-5,9
B1, B2	18	12		20		47,5	28		52,5		21,4	21,3
A1, A2, A3	25	17		42,5	24	43	26		73,5	35	11,5	11,6
	148	100		178	100	167,5	100		211	100	2,5	3,5

CELMA ballast sales figures indicate that while in 2000 only 17% of ballasts sold were electronic ones, in 2005 already about 1 out of 4 ballasts sold are of the electronic type. CELMA also states that dimmable electronic ballasts only represent 9% of the total electronic ballast market. These figures are in line with the distribution found in Europroms of 85/15 % ferromagnetic versus electronic ballasts (see Figure 16 in section 2.1.3).

Table 24 shows that the total ballast market grows at an average of 2,5% annually in the period 2000 to 2005. While sales of magnetic ballasts of Energy Efficiency Index (EEI) class C and D exhibit an annual decline of 6% in the period 2000-2005, magnetic ballasts of EEI class B1 and B2 display an immense growth pace of about 21% annually. Electronic ballasts grow at a somewhat slower pace; 11,5% annually.

Figure 21 shows the market transformation that is expected by CELMA after 2005.

²⁶ On exemption is the 18W T8 lamp where 2 lamps can be operated at a 36W magnetic ballast.

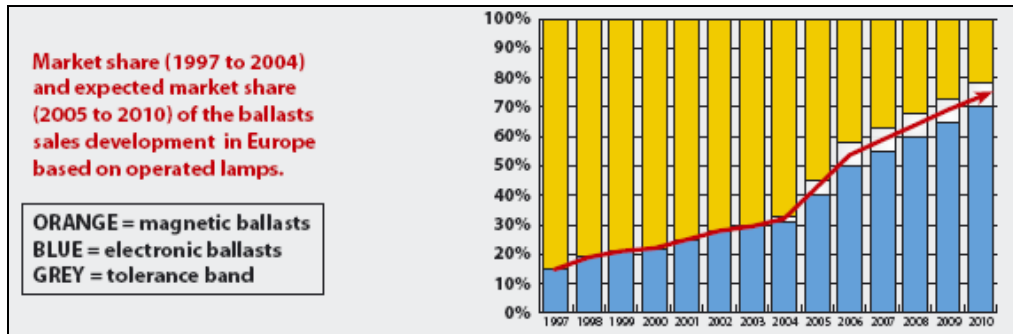

Figure 21: Market share (1997 to 2004) and expected markets hare (2005 to 2010) of the ballasts sales developments in Europe based on operated lamps

Again, the above CELMA-sales figures are representative for the entire lighting market and do not particularly apply for office lighting. No other data covering the entire EU-25 is available however on ballast segmentation for office lighting. Results from the expert inquiry conducted in the framework of this project (see section 2.2.1) indicate that the share of electronic ballasts in new installed office lighting is much higher compared to the above averages for the entire lighting market. Ranges are from 45-50% (UK and Germany) to 65-70% (Spain and Belgium).

2.2.5 Current stock lamps in offices

Various studies have been conducted for various Member States on the installed base of office lighting, also specifying the types of light sources used.

Table 25 shows the results of a study conducted in France (Enertech, 2005).

Table 25: Lamp types used in office lighting in PACA region²⁷, France

FR	Offices (task areas)			Corridors, hallways and staircases	Sanitary facilities	Communal premises	TOTAL
	Cellular office	Landscape office	Desk lighting lamps				
TOTAL n° light points	403	30	154	70	91	99	847
Lamp types	(%)	(%)	(%)	(%)	(%)	(%)	(%)
LFL	90	91	0	54	12	79	61%
18W	43 (41%: 4 x 18W)	47	0	19	No data	40	(28%)
36W	30 (28%: 2 x 36W)	20	0	27	No data	28	(20%)
58W	16 (10%: 2 x 58W)	17	0	4	No data	10	(10%)
Other	1	7	0	4	No data	1	(1%)
CFL	5	0	38	14	14	5	13%
Incandescent	0,5	0	20	10	51	4	11%
Halogens	4	6	42	6	15	5	12%
12V	1	3	42	6	15	3	(11%)
230V	3					2	(2%)
Discharge lamps	1	3	0				1%
Other types				16	8	7	3%

At total office building level, most commonly used lamp type is LFL (61%). The share of CFL, halogens and incandescent in the same order of magnitude (around 11-13%). Discharge and other types of lamps represent only a marginal share (4%).

Of relevance for this study is that it can be concluded that over 90% of the light sources used office task areas (cellular and landscape) are LFL's. Most commonly used wattages are 18W (mostly in luminaire with 4 lamps) and 36 W (mostly in luminaire with 2 lamps).

Only about 5% of light sources in cellular offices are CFL's, and in open plan offices almost no CFL's are used for task lighting.

CFL's are mainly used for desk lighting lamps (38%, besides halogens 42% and incandescent 20%) and to some extent in "non-office work" building areas such as corridors, stairways, communal premises and sanitary facilities (5-15%). However, also these building areas are mainly lit with LFL lamps (79% in communal premises and 54% in corridors, hallways, staircases, etc). Over half of the lamps in toilets are incandescent.

²⁷ Provence-Alpes-Côte d'Azur

In this study, a trend was noticed that new CFL luminaires may actually be replacing old LFL luminaires. However, from the perspective of energy-efficiency, this substitution generates no substantial increase or decrease in energy use. Even though the efficacy of the CFL (including ballast) is generally lower than that of a LFL lamp with ballast, the application could still be more efficient. This is because a CFL luminaire generally offers more possibilities for directing the light towards the task area where it is actually needed, for instance, when combinations of task lighting and ambient indirect lighting replace old lighting systems that provide uniform light levels over a large office space (IAEEL, 1994).

This last argument, together with the fact that CFL light points represent only a minority in office task areas compared to LFL, is of relevance regarding the selection of the Base case where only LFL luminaires are considered (see chapter 5).

Other valuable data retrieved from this study are that:

- 60% of the total floor space of office buildings are cellular or landscape offices, thus floor area where actual office tasks are performed (relevant for parameter 8 in Table 19). Note that desk lighting lamps and lighting for corridors/hallways (20% floor area), communal premises (15% floor area) and sanitary facilities (5% floor area) fall out of the scope of this project as these have a different functionality, e.g. decorative, spot illumination, etc (see section 1.1.1).
- Annual burning hours are estimated at 1155 hrs for cellular offices and 2513 hrs for landscape offices.

Also a study conducted by DEFU “Market research on the use of energy efficient lighting in the commercial sector” (DEFU, 2001) where energy audits were performed of 40 buildings (offices) in 6 EU countries, revealed information on a.o. lamp types, ballast types, luminaire types, floor space, etc.... In this section we focus on the data regarding lamp types (see Table 26).

Note that the DEFU study aggregates shares of lamp use at the whole office building level, while particular for this study data are required at office task area level (cellular office or landscape office space). At this aggregated building-level, the results from the Enertech study for France (percentages in last column of Table 25) can be compared with the percentages in this Table 26.

Table 26: Lamp types used in office lighting in 6 EU Member States (DEFU)

	FR (<i>Enertech</i>)	BE	DK		ES		GR		IT		UK
	<i>Public/ private</i>	public	public	private	public	private	public	private	public	private	<i>Public/ private</i>
Incandescent	11	10	5	10	3	1	6	1	13	2	
Halogen, 230V	2	1			3	1			2		
Halogen, 12V	11	4	2	5	2	6			1	14	
CFL int. ballast		3	5	5	1		1	12		1	
CFL pin socket		2	14	13	4	3	24	23			
Total CFL	13	5	19	18	5	3	25	35			
Total LFL	61	80	75	65	86	87	68	64	81	80	100
Other	4			2	1	3	2	0	3	4	1

This study also confirms that the most commonly used lamp type in office buildings is the LFL, ranging between 64% (GR) and 100% (UK). Substantial shares of CFL is used in office buildings in DK and GR. This table also shows that large variations exist between these 7 (and probably all) EU countries.

The expert inquiry (Table 27) found that, compared to new installations (see Table 22), existing installations in Belgium and Spain still have substantial luminaires in place with other than fluorescent types of lamps. This can be explained by the fact that respondents were asked to estimate lamp types used for ‘office task areas’ and thus also hold desk lighting lamps in mind. A similar ratio of CFL compared to LFL could be found as in the DEFU and ENERTECH study (LFL >90%).

Table 27: Light sources used for existing office lighting, in particular task area (Expert Inquiry)

	Belgium	Germany	Spain
Fluorescent lamps	80%	99%	70%
CFL	10%	5%	15%
T8 LFL	80%	90%	75%
T5 LFL	10%	5%	10%
Other types	20%	1%	30%

2.2.6 Current stock of ballasts in offices

The SAVE report “Market research on the use of energy efficient lighting in the commercial sector” (DEFU, 2001) gathered information on the installed base of conventional versus electronic ballasts in office lighting installations which is presented in Table 28. Ballasts were predominantly conventional. Generally the found market penetration for HF ballasts is only a few percent. UK had the largest proportion 43% of electronic ballasts. Public and private offices in Denmark are around the same level with 18% and 22%. While in public Italian

offices no electronic ballasts were used, they accounted for 37% in private offices. The inverse picture is found in Greece: 0% in private offices versus 25% in public offices. Levels were much lower for Spain at 6% and 3% for public respectively private offices, and Belgium at 2%.

Table 28: Use of ballast technology in percentage for the public and private office buildings

%		Total number (n)	Conventional (or unknown) ²⁸		Electronic
Belgium	public	3058	98		2
Denmark	public	5235	82	82% C	18
	private	3671	78	18% U	22
Spain	public	2455	93,6	91,3% C	6,4
	private	2824	96,9	1,3% U	3,1
Greece	public	8877	75,4	71,9% C	24,6
	private	4362	100	18,5% U	0
Italy	public	1562	99,9	83% C	0,1
	private	2844	62,7	9,4% U	37,3
UK	Public/private	922	57		43
EU-25	Weighted average	35810	30112 (84%)		5698 (16%)

In the Netherlands the Monitor Energy Saving Measures shows that high frequency lighting²⁹ (HF and HF++) makes up 19% of the office lighting installations (SenterNovem).

Information from the Expert inquiry shows that currently 5-10 (Belgium and Germany) to 25% (Spain) of installed base has electronic ballasts in existing installations, while in new lighting installations over 50% (In Germany)has them (up to 65% in Spain and 70% in Belgium).

2.2.7 Current installed base: lighting control

Generally a lighting control (mechanism) can be classified in switch or modulation control, manual or automatic control, and central or local control. Although almost every combination is possible, the most frequently used systems are the automatic local switching on by presence detection, automatic time switch, automatic local daylight compensation and of course the classic manual switches which can be local or central.

²⁸ Denmark: 82% conventional, 18% unknown

²⁹ is economical and does not blink

Table 29: Penetration rate of different lighting control techniques in office lighting

Type of control system used	Data	Ref year	Source	Region
Manual control	97%	2000	DEFU, 2001 in IEA, 2006	Europe-6 ³⁰
Switching on/off per lamp	3-4%		Kantoor 2000	Belgium
Switching on/off per room	68%		Kantoor 2000	Belgium
Switching on/off centrally	19%		Kantoor 2000	Belgium
(Timed) lighting sweep function or switch ³¹	12%	2002	SenterNovem ³²	Netherlands
	11%	2003		
scheduling (timer switchers)	4%	2000	DEFU, 2001 in IEA, 2006	Europe-6
some kind of automatic control (occupancy sensors, daylight dimming, etc.).	3%	2000	DEFU, 2001 in IEA, 2006	Europe-6
Daylight compensation	0,7%		Kantoor 2000	Belgium
Daylight depending lighting	19%	2002	SenterNovem ³³	Netherlands
	22%	2003		
Switching on/off by presence detection	8%		Kantoor 2000	Belgium
Occupancy detection	10%	2002	SenterNovem	Netherlands
	12%	2003		

Information from expert inquiries shows following results on control techniques in office lighting:

Table 30: Penetration rate of different lighting control techniques in office lighting in Belgium and Spain (Source: Expert inquiry)

	In small offices (<30 m ²)			In larger offices (>30 m ² or more than 6 persons)		
	Belgium	Germany	Spain	Belgium	Germany	Spain
Daylight sensors	10%		5%	15%		10%
Individual control for each user	1%		20%	5%		20%
Presence detection	25%		10%	25%		15%

The German respondent remarked that these techniques are heavily promoted but find little acceptance. Next to the common reason that the investment is usually not paid for by the later user, another reason is low customer satisfaction, anger about malfunctioning sophisticated electronic control gear. Adding to this, what is never mentioned in the promotion is that optimized lamps and luminaires already reduce the energy demand of a lighting system to a rather low level and that in turn the automatic control gear also requires some power (usually for 8760h/a), which at least partly offsets the savings achieved during office hours.

³⁰ Results from a survey in six EU countries; No full survey exists for Europe as a whole

³¹ (Timed) lighting sweep function or switch. With a sweep function at a certain moment (for example at the start of a break) the full lighting is switched off. Users have to switch on the lighting again themselves.

³² SenterNovem (2003) Monitor Energiebesparende maatregelen. Rapportage EBM

³³ SenterNovem (2003) Monitor Energiebesparende maatregelen. Rapportage EBM

The mean presence in cellular offices of the PROBE building (Kantoor 2000, Belgium) only amounts up to 52%, clearly indicating that a control according to presence can be of relevance. Results of foreign studies also demonstrate the importance of presence detection.

In Belgium daylight compensation was only found in buildings where already at the design special attention was given to energy efficiency/savings. Only few offices are equipped with dimming that allows to continuously supplement the variable contribution of daylight to the desired lighting level. Substantial energy savings are attainable (Kantoor, 2000). In the Netherlands the Monitor Energy Saving Measures shows that this technique is already much more applied.

The SAVE report “Market research on the use of energy efficient lighting in the commercial sector” (DEFU, 2001) concluded that controls in public office buildings were overwhelmingly manual. Over 90% of rooms had manual controls in all countries except UK. In the UK 85% of rooms had manual control only, 12% had occupancy sensing, the remainder had a mixture of controls including time scheduling. There is a need to establish lighting control in the market place. Lighting control seems to be in the same position as electronic ballasts were a decade ago. The only considerable share of automatic control installed is for UK with 12-28% in offices (DEFU, 2001).

2.2.8 Current stock luminaires in offices

No data is available on the current stock of luminaires in offices for the EU-25. These will be estimated based on office floor area, average office characteristics for cellular and open plan offices and illuminance requirements. This approach is further elaborated in section 2.2.9 on past and future stock of luminaires.

In this section we focus on the shares of A1³⁴ versus A2³⁵ types office luminaires (see chapter 1) in the installed base. Data on this issue could be retrieved from the DEFU study (DEFU, 2001) and the expert inquiry.

The weighted average derived from the DEFU figures gives a distribution of 73% A1 luminaires versus 27% A2 luminaires installed in European offices.

This seems to be well in line with the results retrieved from the expert inquiry. The expert inquiry shows that while in existing lighting installations only 10-15% (Belgium and Germany versus Spain) of the installed base are suspended luminaries (A2 luminaires), in new installations 20% (Belgium), 30% (Spain) to 50% (Germany) are suspended luminaries with direct/indirect light.

³⁴ Only direct light, often ceiling mounted

³⁵ Direct/indirect light, often suspended

Table 31: Use of lighting technology in percentage for the public and private office buildings
(Source: DEFU, 2001)

%		Total number (n)	Direct	Semi-direct	Indirect	Total
			A1	A2		A2
Belgium	public	259	98,1	0,7	1,2	1,9
Denmark	public	486	64	35	1	36
	private	197	78	19	3	22
Spain	public	142	97,9	2,1	0	2,1
	private	116	94,8	2,6	2,6	5,2
Greece	public	337	45,4	38,6	16,0	54,6
	private	232	68,5	27,6	3,9	31,5
Italy	public	257	92,6	1,2	6,2	7,4
	private	344	44,5	52,6	2,9	55,5
UK	public / private	258	99	0	1	1
Total (Weighted average)		2628	1926 (73%)			701 (27%)

2.2.9 Past and future stock of office luminaires

The IEA Light's Labours' Lost study (IEA, 2006) mentions that according to the Freedonia forecasts (Freedonia, 2004 in IEA, 2006) there will be a greater rate of growth in the global lighting-luminaire market up to 2008 than occurred in 1998–2003, as a result of increased manufacturing and construction activity triggered by global economic growth, continuous urbanisation and the expansion of electricity grids in rural areas. Not surprisingly, the rate of growth is projected to be highest in the developing areas of Asia-Pacific, Eastern Europe, Africa, the Middle East and Latin America. Demand for lighting luminaires in Western Europe is projected to grow by 4.0% per annum, which is well above the 2.9% growth rate registered over the period of 1998 to 2003.

For office lighting luminaires in particular, there are no studies or data available on the current stock of luminaires, neither past or future projections. For this reason, an approach is chosen in this study to estimate the current, past and future stock and sales of luminaires based on the evolution in office floor area, the evolution in illuminance requirements. When knowing the surface that can be lit with one luminaire (parameter A) according to this illuminance requirements, one only has to divide the total office task area with this figure to results in the amount of luminaires that are required for this purpose. When knowing the (future) annual increase in office area, one can calculate the new luminaire sales for new offices. When knowing the (past) annual increase in office area in combination with the average luminaire lifetime (replacement period), one can calculate the new luminaire sales for existing offices.

The market data that is required for this analysis is summarized in the Table 19, more in particular EU-total market data parameters 1 to 11 in the table.

Copy of Table 19, parameter for EU-25 totals calculation, 1 to 11

1	Share Cellular Offices	% (of floor area)
2	Share Open plan (landscape) Offices	% (of floor area)
3	Share A1 direct lighting	% (of floor area)
4	Share A2 direct+indirect lighting	% (of floor area)
5	EU25 total office space	m2 floor area
6	Annual increase office space (before2005, after 2005)	%
7	Annual increase office space	m2 floor area
8	Share task area (of total office floor area)	% (of floor area)
9	Average illuminance, \bar{E}_m (installed base)	lx (for task area)
10	Average illuminance, \bar{E}_m (new)	lx (for task area)
11	Average luminaire life	yr

The share of cellular offices versus open plan offices (1 and 2 in table) will be discussed in this section 2.2.9.

The share of A1 direct versus A2 direct/indirect luminaires (3 and 4 in table) is already discussed in section 2.2.8.(result of the DEFU study).

The current EU25 total office space and annual increase (5, 6 and 7 in table) will be discussed in this section 2.2.9.

The percentage of the total office area that is used for performing office tasks (8 in table) is already discussed in section 2.2.5 (result of the Enertech study).

The illuminance of existing office lighting installations and the illuminance of newly installed office lighting installations is (9 and 10 in table) is discussed in this section 2.2.9.

The average luminaire life or luminaire replacement period will be more elaborated in this section 2.2.9. In chapter 4 on technical product analysis; an extensive description of the technical lifetime of the luminaire and lighting components will be given.

The surface that can be lit per luminaire (A) is determined by the performance of the luminaire configuration itself (thus luminaire in combination with the lamp(s) and ballast(s)) and by the characteristics of the task area room (i.e. height of the room, reflectance of walls, etc... which is different for cellular and open plan offices). How this surface A is calculated is discussed in detail in chapter 4 on technical analysis. This surface per luminaire (A) is calculated for each Base case luminaire (chapter 5) and for each luminaire where improvement options are applied (chapter 6). Regarding improvement options, we thus also take into account the fact that when the performance of individual luminaires increase (more 'functional lumen output' per luminaire), less luminaires could be used to lit a given surface of task area.

2.2.9.1 Cellular versus open plan offices

No data could be found for EU25, or at Member State level. Only The Kantoor 2000-study for Belgium reports that 48% of total offices are landscape³⁶ offices and 52% cellular³⁷ offices. Although one intuitively distinguishes between landscape offices-intended for use by a group of people- and cellular offices- intended for only one or few user(s)- employing a strict definition seemed necessary in real terms. The share of landscape versus cellular offices strongly varies between buildings³⁸ and is closely connected to the company philosophy and activity. On the average over the full building sample, the share of both types of offices are almost equal.

2.2.9.2 Illuminance (\bar{E}_m) of existing office lighting and of new installed office lighting

The applied illuminance levels are key parameters of lighting energy demand. Illuminance levels have evolved over time. In our inquiry was asked for the illuminance requirements in lux in 1990 and in 2005 for the different EU-countries. Because only a few answers on our inquiry were received, some values as listed in Table 2.1 from the IEA publication “Light’s Labours Lost” were used.

Some remarks have to be made:

- for 2005, assumption is made that the illuminance value (500lx) for normal office work as requested by the new European standard EN 12464 is applied (our inquiry shows that this is common practice); only in Denmark, the Danish Electricity Saving Trust proposes a general lighting installation in offices that provides 300lx, completed by individual desk lamps to get 500lx on the task area
- before the new European standard, several countries made a differentiation for offices where also visual display tasks were carried out (required values were lower 150-500lx)
- in at least one country (Belgium) the recommendations of the existing standard (500lx) were overruled by the law on safety and health on working places that required only 300lx.

The results of the search are summarized in Table 32 here below.

Table 32: Illuminance levels in lux

Year	Austria	Belgium	Czech republic	Denmark	Finland	France	Germany	Netherlands	Spain	Sweden	United Kingdom
1990	500	300*	300	300*	500	425	500	400	500*	300	300*
2005	500	500*	500	300/500*	500	500	500	500	500*	500	500*

³⁶ A landscape office in “Kantoor 2000” has more than one work station and a net floor space of minimum 40m²

³⁷ A cellular office in “Kantoor 2000” has or only one work station (where size does not matter), or has more work stations but is smaller than 40m²

³⁸ Variations are huge though: some buildings only have cellular offices, others have only landscape offices

* based on inquiry results or direct information

Taking into account that, in 1990, for normal office tasks values between 300 and 500lx were applied and that sometimes for visual display tasks even lower values were met, 400lx is assumed as the EU-25 standard illuminance value for 1990; for new installations (2005 and later) 500lx is assumed.

2.2.9.3 Current total EU-25 office space and expected growth in EU-25 office space

The UNECE database³⁹ reports annually the new number, area and volume of commercial buildings (to which office building belong) for all EU-25 Member States except Czech Republic, Ireland, Latvia, Austria and Slovakia. According to this source, in the period 1990-2000, an average annual growth of 35,6 km² commercial building area occurred (see Table 33). Knowing that the 5 Member States of which data are missing in the UNECE database represent 6,6% of the total EU-25 population in 2004, simple extrapolation gives a total annual increase of 38,13 km² commercial building space.

According to Enerdata⁴⁰ the share of the offices floor area in the total service sector building floor area is approximately 17% (the remainder surface thus used for among others; wholesale, retail and service trades, i.e. hotels, restaurants, shops, warehouses, public garages, etc...). This results, based on UNECE, in 6,5 km² annual office space increase for EU-25.

Also, according to latest estimations by Enerdata for 2004, the total surface area of service sector building is around 7600 km² in 2004. Applying this same share of 17% for office buildings, this results in 1139 km² total office space. According to (Enerdata, 2003 and IDDRI, 2004) floor space has been growing by 2% per year for market services (offices, tourism, telecommunications, etc.) When applying this growth rate to 1139 km² total office space, this results in 22,78 km² new office space annually. This is 3,5 times higher than the figure based on the UNECE database. For the base scenarios (see chapters 5 and 8), the figures presented by Enerdata are used because we believe these are more up to date and also, the UNECE database misses data for several countries for several years. In a sensitivity analysis this office area aspect is considered (see chapter 8).

Data of European office surfaces can also be retrieved from the SAVE project “European GreenLight: Saving potential and best practices in lighting applications and voluntary programmes” (Novem, 1999) for countries/regions of EU-15 and from the Ecofys report “Cost-effective climate protection in the Building stock of the New EU Member States: Beyond the EU Energy Performance of Buildings Directive” (Ecofys, 2005) for the new-8 Member States.

Extrapolating the floor area of offices in the EU-15 Member States (Novem, 1999) based on population, an indication of the total office surface in the new Member States can be derived

³⁹ This is based on the database model of the Statistical Division (UNECE/STAT) and maintained by the Environment and Human Settlements Division, with specific reference to data on housing and building. Data are collected for the ECE Bulletin of Housing and Building Statistics and through the Country Profiles on the Housing Sector from a number of both national and international sources.

⁴⁰ Personal communication with Mr. LAPILLONNE of Enerdata, France

(see Table 34); and an indication of the total EU-25 office surface: approximately 840 km² office surface.

In the Ecofys report estimates are made for the non-residential building stock for the new-8 Member States. Assuming that 1 out of 4 non-residential buildings is an office building, the thus resulting EU-25 office surface seems to be well in line with the total office stock surface derived via extrapolation based on population.

Combining this EU-25 office building stock of 840 km² with on average 0,13 luminaires/m² (Enertech, 2004) implies an installed base of some 110 million luminaires in European offices.

Table 33: Area of new commercial buildings (000's m²): 1990-2002 (UNECE)⁴¹

Country	1990	1991	1992	1993	1994	1995	1996	1997	1998	1999	2000
Belgium	1080	3443	3340	2874	3202	1964	2099				
Cyprus	487	490	607	468	351	408	398	343	282	366	280
Denmark		1214	898	723		775	890	993	1046	1364	1168
Estonia			24	32,3	68	40	45	58	111	76	140
Finland	2049	1749	1404	836,4	736	488	671	622	818	1138	1150
France	21061	17621	14312	11899	10866	10311	9579	10140	11383	12645	
Germany		8200	9007	11610	13065	12819	11850	12243	11250	11064	
Greece	1176	968	908	782	812	696	636	573	531	673	
Hungary	546	518	303	178	542						
Italy											
Lithuania					63	83	84	109	178	147	274
Luxembourg	57,9	116	141	71	128	223	70	24	260	103	
Malta											
Netherlands	6800	6202	5986	4770	5068	4997	6120	6850	8400	9762	7851
Poland											
Portugal											
Slovenia	112	200	145	250	214	168	281	315	479	433	435
Spain									1913		
Sweden							394	630	941	1064	1359
United Kingdom											
EU-20 (km2)	33,4	40,7	37,1	34,5	35,1	33,0	33,1	32,9	37,6	38,8	12,6

⁴¹ Source: United Nations Economic Commission for Europe, 2002 – last updated on 30/08/2006

Table 34: Derivation of office building stock in EU-25 (Novem and Ecofys)

	Population number	Office surface/floor area			Non-residential Total	Share of office in non-residential	Office surface Total
		Total	Per inhabitant	Total			
Reference region		EU-15	EU-15	New MS	New MS	New MS	
Reference year	1999	1999	1999	1999	2002	2002	2002
Source		SAVE report-Novem, 1999	Derived	Derived	Ecofys, 2005	Assumption	Derived
Unit	000's inhabitants	000's m ²	m ² /inhabitant		000's m ²	%	000's m ²
NORTH							
Denmark	5.313,6	15.060	2,83				
Finland	5.159,6	11.295	2,19				
Sweden	8.854,3	21.084	2,38				
Average			2,47				
Estonia	1.379,2			3.406	13.900	0,25	3.475
Latvia	2.399,2			5.926	27.400	0,25	6.850
Lithuania	3.536,4			8.735	31.700	0,25	7.925
WEST							
Ireland	3.732,2	3.012	0,81				
UK	58.579,7	106.325	1,82				
Average			1,31				
CENTRAL							
Austria	7.982,5	19.578	2,45				
Belgium	10.213,8	23.343	2,29				
Germany	82.037,0	162.801	1,98				
Luxembourg	427,4	3.012	7,05				
Netherlands	15.760,2	48.947	3,11				
Average			3,38				
MID							
France	58.496,6	121.386	2,08				
Average			2,08				
Czech Republic	10.289,6			21.402	105.200	0,25	26.300
Hungary	10.253,4			21.327	91.300	0,25	22.825
Poland	38.667,0			80.427	286.300	0,25	71.575
Slovenia	1.978,3			4.115	18.300	0,25	4.575
Slovakia	5.393,4			11.218	51.300	0,25	12.825
SOUTH							
South	117.726,7	145.923	1,24				
Greece	10.861,4						
Italy	56.913,6						
Portugal	10.148,9						
Spain	39.802,8						
Total	117.726,7						
Average			1,24				
Cyprus	682,9			847			847
Malta	378,5			469			469
Total EU-15		681.766					
Total New MS				157.872			157.666
EU-25				839.638			839.432

This growth rate for office floor area of 2% annually is also confirmed by other studies.

The publication “RICS Office property market: German demographic trends and the property market” (2005)⁴² describes the translation of demographic trends onto the business demand for office space. RICS thinks the current trend towards greater service activity is likely to initially dominate over the next 10-15 years, leading to further rises in office based employment and real estate requirements. However, from 2020-2030 onwards as the worse of the labour force decline takes hold with the retirement of the baby-boomers, the demand for office space is still likely to fall.

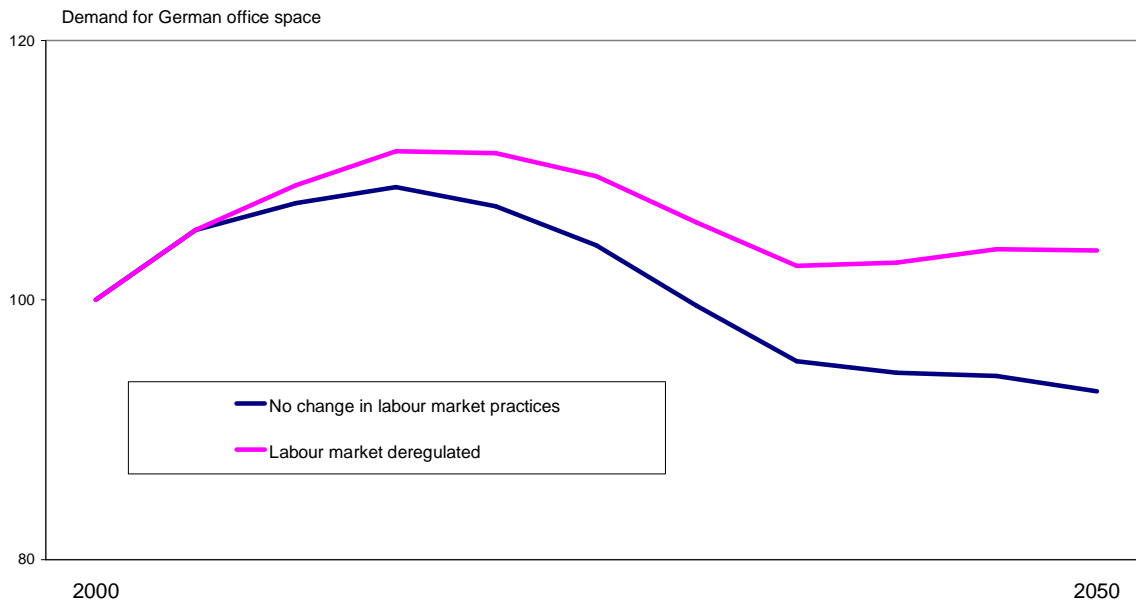

Source : Federal Statistics Office, United Nations World Population Prospects Database, RICS calculations

Figure 22: Likely pattern of change in office space demand due to demographic pressures

Also a study in the Netherlands (NYFER, 2001) states that the further increase of employment is stopped by the limits of a decreasing supply of labour (labour market). The levelling off/flattening growth of employment will mean a smaller demand for additional new office surface. NYFER estimates that in 2009, 39,6 to 42,7 million m² r.f.s. (rentable floor surface) solitary office space is needed in the Netherlands. This implies that between 1999 and 2009 the office stock can increase with 5,4 to 8,5 million m². When the supply of labour can increase more than expected by successful government policy then an increase of 8,5 million m² in 10 years is possible (2,25% annual office growth). When this does not succeed and furthermore the economic climate turns out badly then an increase of 5,4 million m² is more probable (1,47% annual office growth). The most probable scenario starts from an annual growth of employment of 1%. In that variant the office demand increases with 6,4 million m² in the period 1999-2009 to 40,6 million m² in 2009 (1,73% annual office growth).

⁴²Source: Federal Statistics Office, United Nations World Population prospects Database, RICS calculations
<http://www.rics.org/Property/Commercialproperty/Officeproperty/Officepropertymarket/German%20demograp hics%20trends%20and%20the%20office%20market.html> (last consulted: March 2005)

The Belgian federal planning Office foresees in a scenario that the total surface of office buildings and storage rooms used for services will rise with 149% between 2001 and 2050, implying an annual growth of 2% (FPB, 2006a).

2.2.9.4 Average luminaire life

Because the life time of lighting equipment being shorter than of buildings, there is a natural need for recurring retrofits (ATLAS, 2006).

A measurement campaign in offices in the PACA region in France showed that the average age of a luminaire for fluorescent tubes is 10,1 years (Enertech, 2005).

The SAVE report (Novem, 1999) reports an average life of a lighting installation in offices in EU-15 of 24 years: ranging from 19 years in the West region (reported by UK and Ireland) to up 28-30 years in the North region (reported by Finland and Denmark respectively).

Experience in the Netherlands shows that in half of the offices a lighting system of over 20 years is installed. These miss out on the technological developments and the savings. Philips states that office lighting is often out-of-date because the rate of replacement is very, very slow. Per office, yearly 7 to 10% of the lighting is replaced; so it takes about 15 year before a lighting installation is replaced (Berno Ram in Van de Wiel, H., 2006).

In (Ecofys, 2005) this concern is also stated. The average lighting stock gradually improves as newer, more efficient installations replace old, inefficient ones; however, much of the existing stock remains unchanged. The governments of the New Member States report the highest level of need for refurbishment in the EU.

The above data are also consistent with the information retrieved from the expert inquiry: in Belgium, Germany and Spain lighting installations are currently being renewed in offices on average every 15-20 years. The German respondent remarked that a partial renovation, refurbishment or repair will be more frequent, a total reinstallation less.

2.3 Market trends

2.3.1 General trends in product design and features from marketing point of view

1. Lamps

Lamps are currently replacement parts for a luminaire because lamp life is typically 5-7 years while luminaires are used for typically 20 years. LEDs could change this by making lamps that last as long as the luminaire. We will consider the LED technology behind these developments under the BNAT paragraph in chapter 6.

Fluorescent lamps are introduced in various shapes (diameter T12/T8/T5, linear, circular, u-shape, ..) to fit in various designs.

Some manufacturers are offering 'retrofit kits' for applying T5-lamps in luminaires designed for T8-lamps with magnetic ballasts. The magnetic ballast is kept and an additional electronic converter is placed in the old socket. This option is not considered in this study, because lamp lumen output and light distribution doesn't match with the original design. An alternative retrofit solution is also to replace the magnetic ballast by an electronic ballasts; this provides an energy saving while the original light output and light distribution is kept but it requires extra luminaire rewiring work. Both solutions are neither known as common practice nor as BAT; therefore they are not included in the scenarios (chapter 7 and 8).

2. Ballasts

Each defined lamp type and wattage needs its ballast control circuit. A consequence of this is that once the ballast is installed in the luminaire, it is very difficult to change lamp power or type. There is a new trend in electronic ballasts to make 'multi-watt' and 'multi-lamp' ballasts, making distribution and stock more easy.

Also the control interfaces for dimming ballasts are extended (e.g. wireless control, ..)

Another new trend is to develop lamp types (e.g. T5) that can only be operated by electronic control gear; they benefit from a better lamp-control gear compatibility (e.g. more accurate power and lamp voltage control) and, in the opinion of the lamp manufacturers, this results in a longer lifetime.

There are also manufacturers of electronic starters who claim longer lamp lifetime with their starters. This improvement is not confirmed by the lamp manufacturers (see stakeholder meeting 2 April 2007). The electronic starter is more expensive and as a consequence not proliferated on the market. Therefore this solution is neither known as common practice nor as BAT; as a consequence it is not included in the scenarios (chapters 7 & 8).

3. Luminaires

In the luminaire market, product differentiation arises from technological innovations, design and price.

Technological innovations will be described in the BAT chapter later in this report. An important new trend is to pay more attention to luminaire design in order to fit in interior design projects.

Luminaires design trends can play an important role and follow design trends from interior design that are close to cultural and art trends. These trends can change fast over time and can vary from very ornamental luminaire designs following classic baroque design elements to minimalistic designs that are very close to contemporary art trends. These trend can also motivate and appeal more costumers to buy new equipment compared eco-design or energy efficiency alone because they are more visible and offers consumers the ability to differentiate themselves. These trend can offer possibilities if new eco-design approaches are integrated in these products but can also offer a tread if designers feel limited in their creativity with possible boundary conditions imposed by eco-design. It is important that the various designers that influence these trends have 'eco-design' skill and finally eco-design could be a trend too.

2.3.2 Description of market and production structure and identification of major players

Office lighting purchase process

The purchase process of office lighting is a typical 'Business to Business' (B2B) market. The market structure and the 'consumer behaviour' of various subcontractors are described in chapter 3.

Global lighting production market

The global lighting-product manufacturing industry is made up of many enterprises ranging from large multinational private companies that manufacture a broad range of lighting products to small single-product firms, which may be publicly or privately owned. (IEA, 2006).

When viewed as a region, the European Union is the world's largest producer of lighting equipment in terms of value, although China now probably surpasses it in terms of volume (IEA, 2006). The European lighting manufacturing industry has annual revenues of about EUR 13 billion, of which EUR 5 billion (USD 6.2 billion) is from lamp manufacture (ELC, 2005 in IEA, 2006) and EUR 8 billion from luminaires, ballasts and associated electro technical equipment (CELMA, 2005 in IEA, 2006). Lamp manufacturers are represented by the European Lamp Companies Federation (ELC), which includes among its members⁴³ Philips Lighting, OSRAM, GE Lighting, Aura Lighting Group, BLV, Leuci, Narva and Sylvania Lighting International (SLI). The European activity of these companies employs roughly 50 000 people and produces an annual revenue of EUR 5 billion⁴⁴ (IEA, 2006).

Manufacturers of luminaires and electro technical parts for luminaires are represented by a European federation of national industry associations called CELMA. The 16 national member associations of CELMA represent some 1 200 companies in 11 European countries. These producers, which include many SMEs, directly employ some 100 000 people and generate EUR 8 billion annually. CELMA claims to supply more than 90% of luminaires and associated electro technical parts for the EU market (IEA, 2006).

Market shares and competition

The extent to which an industry's market share is dominated by relatively larger firms is referred to as "market concentration". Market share can represent financial power in the marketplace; typically, the mark-ups that firms pass on to consumers increase as the concentration of the market increases (Atkinson et al. 1992 in Vorsatz et al., 1997). In general, the lamp and ballast market is highly concentrated, with a limited amount of players, whereas the luminaire market is very fragmented.

Below, we discuss the number of manufacturers, as well as market share, for lamps, ballasts, luminaires and controls.

1. Lamp market:

Lamps are a globally traded commodity and there is a high degree of standardisation between international lighting markets. For several decades three major multinational lamp manufacturers have dominated the international lamp market: Philips, based in the

⁴³ ELC, Make the switch: The ELC roadmap for deploying energy efficient lighting technology across Europe http://www.elcfed.org/uploads/documents/-3-01elc_a5report_6_05.pdf

⁴⁴ <http://www.elcfed.org/index.php?mode=0>

Netherlands; OSRAM, based in Germany; and General Electric, based in the United States. Sylvania is another large multinational lamp manufacturer whose North American operations were merged with OSRAM's in the 1990s but is a separately owned brand elsewhere. While these companies have a strong presence in almost all global markets their strength in any one sector or region varies appreciably. (IEA, 2006).

European lamp manufacturers are grouped in the ELC (The European Lamp Companies Federation), they have 8 members and claim 95 % of the total European lamp production.

There is a large import of lighting products from China (IEA, 2006) but it is unlikely that they are imported for the B2B professional office luminaire market.

2. Ballast market

Most of the large lamp manufacturers also sell ballasts. There is also a large group of manufacturers that only produces ballast including ballasts ranging from SMEs to large companies. The main players are a.o.: ELT, ERC, Helvar, Tridonic, Vossloh-Schwabe, ...

The market is dominated by magnetic ballasts anno 2004 (see previous paragraphs). Some companies might experience/suffer severe competition if electronic ballast technology takes over the old ferromagnetic control gear technology because other production lines and technological competences are needed. The switch from magnetic to electronic ballasts will also affect the copper and silicon steel industry because lower volumes of these materials are needed. In general more copper or magnetic material is good for the energy efficiency in both magnetic and electronic ballasts because of the lower copper and magnetic losses but a switch from technology can cause an important decrease of copper or magnetic steel use for the same energy efficiency. Magnetic ballasts dominate nowadays the very basic linear fluorescent luminaires sold for the domestic market, they offer a very low cost solution per lumen and have competitive purchase prices compared to inefficient incandescent or halogen luminaires.

There is a large import of lighting products from China (IEA, 2006) but it is unlikely that they are imported for the B2B professional office luminaire market.

3. Luminaire market

There is a large import of lighting products from China (IEA Light's Labour's Lost, 2006) but it is unlikely that they are imported for the B2B professional office luminaire market.

An office luminaire has a low weight to volume ratio due to the dominant aluminium sheet construction technology and transport costs can become relative high. This could explain in part the relative low import.

2.3.3 Duration of redesign cycle of the EuP

The duration of the redesign cycle for an office lighting product can range from several months to many years. A new technology for light production can need tens of years from first idea to functioning technology and working prototype. New lamps and new ballasts based on the same or similar existing basic technology can need redesign cycles up to several years, mainly depending on the needed long term reliability testing cycle. A simple modification in luminaire design can sometimes be done in months. Totally new luminaire designs changing all functional and optical parameters can require a design cycle from 6 months up to two years.

2.3.4 Latest consumer tests

In Switzerland the 'SN 520 380/4' standard was introduced in 2006. The 'Swiss agency for efficient energy use' (S.A.F.E.) (Gasser⁴⁵ (2005)) calculated the 'Luminous efficiency of Luminaires (lm/W)' according to this standard for 16.000 luminaires that were included in the Relux software database.

Energy-efficiency of Luminaires – Evaluation

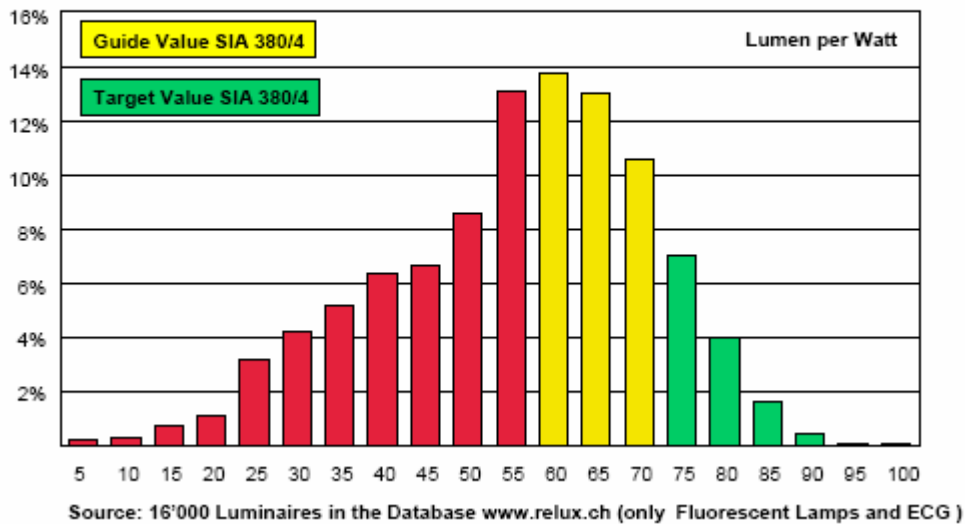

Figure 23: Energy-efficiency of luminaires according to SIA 380/4.

The US Department of Energy (DOE) has published recommended LER values and Best Available values (Table 35) LER is defined in NEMA standard LE 5-2001 (see chapter 1).

⁴⁵ Gasser (2005), 'New Swiss Norm for Lighting (Standard SIA 380/4)', presented on 'Light Summit 2005'.

Table 35: Recommended and best practice values according to US DOE.

Efficiency Recommendations				
Luminaires (NEMA Designation)	Type	Number of Lamps	Recommended LER	Best Available LER
2' x 4' Recessed				
Lensed (FL)		2	62 or higher	77
		3	61 or higher	77
		4	61 or higher	77
VDTc-Preferred Louvered (FP)		2	50 or higher	62
		3	51 or higher	68
		4	54 or higher	68
Plastic Wraparound				
Four-Foot (FW)		2	63 or higher	88
		4	62 or higher	100
Strip Lights				
Four-Foot (FS)		1	70 or higher	86
		2	70 or higher	92
Industrial				
Four-Foot (FI)		1	67 or higher	91
Eight-Foot (FI)		2	68 or higher	86
2' x 2' Recessed, for U-Tube Lamps				
VDT-Preferred		2	41 or higher	63
Lensed		2	49 or higher	78

ENEC (European Norms Electrical Certification) is a voluntary mark for luminaires, luminaire components, electrical and electronic office and IT equipment, safety isolating and separating transformers, power supply units and switches for household appliances. It certifies the compliance of a product with the harmonized European standards. ENEC is widely recognized throughout Europe. Under the ENEC program, applicants can be accepted worldwide, with the exception of luminaires, which is open to manufacturers in Europe only.

The ENEC mark requires that all related EN standards are applied, e.g. for electronic ballasts it requires standard EN 60929.

2.4 Consumer expenditure data

2.4.1 Product prices

Eurostat data are not suitable to derive product prices (luminaires, lamps, ballasts, other replacement parts).

For product prices, we therefore used catalogues of manufacturers. Taking into account that the prices displayed in manufacturers catalogues are for retail trade, realistic assumptions for the prices of different lighting parts were made based on our own experience of the market, e.g. 60% of the retail price for luminaires and 45% for the lamps. For ballasts, we use the OEM prices that were given by the luminaire manufacturers.

Gross indicative prices from a manufacturers catalogue for classical equipment in standard offices are for example⁴⁶:

T8: 120€ excl VAT

T5: 220€ excl VAT

For detailed lamp, ballast and luminaire prices (related to their performance) that were used in this study, see section 4.3 (Table 62, Table 64, Table 65, Table 66 and Table 68).

2.4.2 Electricity rates

Electricity consumption accounts for the most important part in lighting costs⁴⁷, also in office lighting. Electricity rates (euro/kWh) are subject to fluctuations due to recent market liberalisation.

Eurostat reports every 6 months on electricity prices for final domestic household consumers and for industrial consumers (see Table 36).

Office lighting is mainly operated by big real estate companies, ESCO's,...national and regional authorities and the prices that they pay are not collected by Eurostat. We assumed however that these real estate companies negotiate prices that are equal to the industry and therefore the Eurostat EU 25 average price is used in this study, 0.09 Euro per kWh excl. VAT.

⁴⁶ Figures from the firms Trilux and Philips Lighting, both partners in the consortium Green Light Flanders

⁴⁷ In general lighting it would amount up to 79% of the total cost (Source: IEA, 2006)

Table 36: Electricity prices for household and industry consumers

Member State	Overall price (euro/ kWh)			
	Electricity price for		Commercial electricity cost	Electricity price tertiary
	Domestic ⁴⁸ consumers	Industrial consumers ⁴⁹		
Source	Eurostat		Novem, 1999	EC DG JRC, 2004b. Proceedings of workshop on “Electricity end-use in buildings: a survey of new Member States and Candidate Countries”
Austria	0,1391	0,0964	0.09	
Belgium	0,1429	0,1014	0.08	
Cyprus	0,1203	0,1147		0,107
Czech Republic	0,0871	0,0693		
Denmark	0,2320	0,1099	0.06	
Estonia	0,0713	0,0555		0,059
Finland	0,1038	0,0669	0.04	
France	0,1194	0,0691	0.06	
Germany	0,1801	0,1081	0.08	
Greece	0,0694	0,0703	0.07	
Hungary	0,1147	0,0951		0,0714
Ireland	0,1436	0,1056	0.07	
Italy	0,2010	0,1236	0.07	
Latvia	0,0829	0,0482		0,0426
Lithuania	0,0718	0,0588		0,0503
Luxembourg	0,1502	0,0902	0.08	
Malta	0,0769	0,0746		0,08
Poland	0,1059	0,0664		0,0768
Portugal	0,1380	0,0772	0.07	
Slovak Republic	0,1330	0,0828		0,067
Slovenia	0,1049	0,0734		
Spain	0,1097	0,0836	0.07	
Sweden	0,1333	0,0544	0.04	
The Netherlands	0,1960	0,1071	0.06	
United Kingdom	0,0926	0,0781	0.08	
EU-15 average			0.07	
New MS-average				0,069
EU-25 average	0,1363	0,0904		

⁴⁸ Eurostat collects data every 6 months for 5 categories of household consumption, ranging between 600 kWh to 20.000 kWh. Table 36 refers to ‘medium sized household’ (annual consumption of 3.500 kWh of which 1300 during night)

⁴⁹ Eurostat collects data every 6 months for 9 categories of industry consumption (defined by a combination of annual consumption (in MWh), maximum demand (in kW) and annual load (hours)) ranging from Ia: 30 MWh annual consumption, 30kW maximum demand and 1000h annual load; to Ii: 70.000 MWh annual consumption, 10.000 kW maximum demand and 7000h annual load. Table 36 refers to ‘medium sized industry’ (annual consumption of 2.000 MWh, maximum demand 500 kW and annual load of 4.000hours)

2.4.3 Repair, maintenance and installation costs

Maintenance costs may have a major impact on equipment choices: for long time uses, one may prefer long life duration light sources to spare on employment refurbishing costs. Lack of understanding of the consequences of poor maintenance leads to many lighting installations being poorly maintained. There are indications that the benefits of maintenance are not clearly understood by lighting owners (ATLAS, 2006).

For estimating the maintenance and installation cost we use the average hourly labour cost of €21.22 representative for EU25 (Eurostat, data for 2004). We assumed that this activity is connected to 50 % overhead costs. This 50 % overhead will be included in the estimated average *total* labour cost (see Table 37). In this study further LCC calculation will be done with estimated average total labour cost.

The required installation and maintenance time, estimates are included in Table 37 on the basis of experience.

Table 37: Estimation of maintenance and installation cost related parameters used for LCC calculations in this study

EU25 average hourly <i>total</i> labour cost (including estimated overhead costs)	€31.83
Time required for installing one luminaire (t-luminaire install)	20 min.
Time required for group lamp replacement (t-group relamping)	3 min.
Time required for spot lamp replacement (t-spot relamping)	20 min.
Time required for luminaire cleaning (in addition to time for group lamp replacement) (t-luminaire cleaning)	1,5 min.

2.4.4 Interest and inflation rate

Inflation rates are published by Eurostat and interest rates by the ECB.

This study will use the EU25 average rates from these sources:

- inflation rate = 2,1 % (source Eurostat⁵⁰);
- interest rate is about 3,9 % (source ECB⁵¹).

⁵⁰ EU25 Annual Inflation (%) in Dec 2005 Eurostat "Euro-Indicators", 7/2006 - 19 January 2006.

⁵¹ Source: ECB long-term interest rates; 10-year government bond yields, secondary market. Annual average (%), 2005

Please note that these values can vary on a monthly basis and are related to currency (Euro-zone and outside Euro-zone member states).

3 CONSUMER BEHAVIOUR AND LOCAL INFRASTRUCTURE

Consumer behaviour can -in part- be influenced by product-design but overall it is a very relevant input for the assessment of the environmental impact and the Life Cycle Costs of a product. The scope of this chapter is to identify barriers and restrictions to possible eco-design measures, due to social, cultural or infra-structural factors. A second aim is to quantify relevant user-parameters that influence the environmental impact during product-life and that are different from the Standard test conditions as described in Subtask 1.2.

3.1 Definition of 'consumer'

For office lighting it is important to discriminate two main types of consumer:

1. The consumer responsible for the putting into service or further called the '*service provider*'.
2. The consumer that makes use of the office lighting equipment or further called the '*user*'.

In the office lighting market the 'service provider' and 'user' are seldom the same. The 'primary service provider' for office lighting is often the 'office building owner' and the 'user' is almost exclusively the 'office worker'.

The impact of the 'service provider' on energy used to light office buildings is significantly affected by the choices made during the design and construction of buildings, and lighting systems are an integral subcomponent of this process (Xenergy (200)).

To understand how lighting systems are designed and specified, it is important to understand the nature of the relationships among the 'primary service provider' and the many 'subcontractors' that are involved in the building design and construction process.

There exist several contractual relationships between the many involved 'service providers' and finally the producer or importer of lighting equipment during the construction of a new building or as part of a major retrofit (Xenergy (2000)). These relationships frequently determine how information moves between parties and how decisions are made that affect the quality, cost and efficiency of lighting. The best practice and most sophisticated common contractual relationship is enclosed hereafter (fig. 3.1).

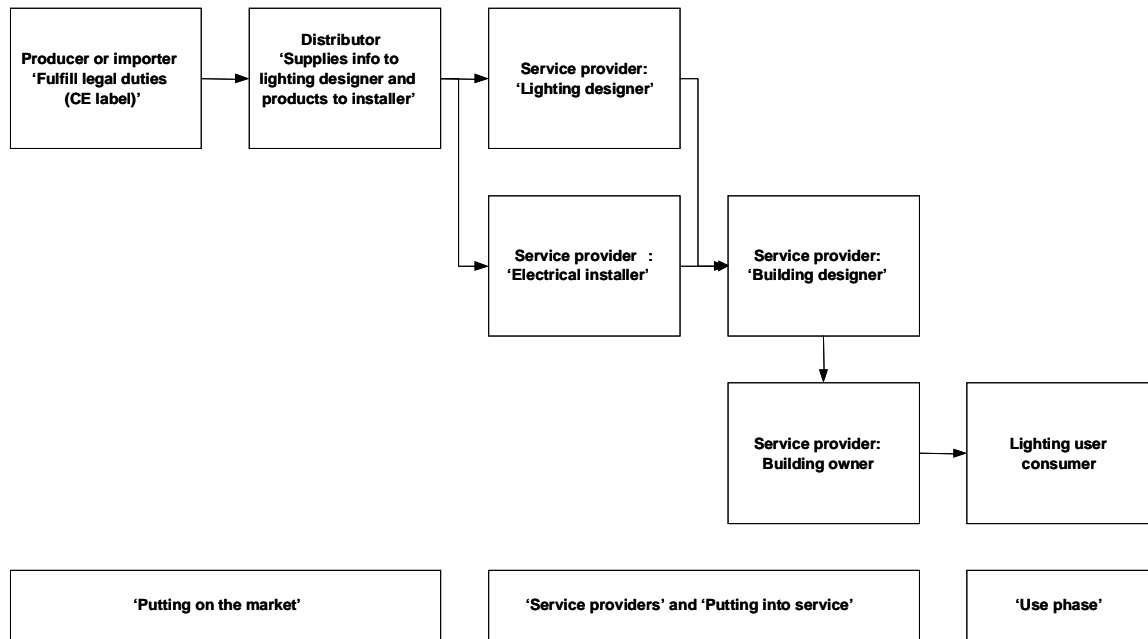

Figure 24: Best practice contractual relationship between 'Building owner' and 'Producer or importer'.

Of course many alternative trajectories can be followed by the 'Building Owner' ranging from self installation and purchase of luminaires in a DIY shop up to the scheme above (Figure 24). However it is obvious that the best results can be obtained when a professional lighting designer is involved (Xenergy (200)) that calculates the lowest energy best fit.

Also various relationships between the 'Building owner' and 'lighting user' can exist. The 'building owner' can be the employer of 'office workers' or alternatively a real estate rental company. It is outside the scope of this study and aspects related to the energy efficiency of the building are part of the EPB directive.

3.2 Real Life Efficiency and quantification of relevant parameters

3.2.1 Lamp efficacy, lamp efficiency, lamp colour spectra and the sensitivity of the human eye

It is important in the context of lighting that the standard performance parameter on lamp 'efficacy' is defined taking into account the sensitivity of the human eye.

Photopic vision (Figure 25) is the scientific term for human colour vision under normal lighting conditions during the day. The human eye uses three types of cones to sense light in three respective bands of colour. The pigments of the cones have maximum absorption values at wavelengths of about 445 nm (blue), 535 nm (green) and 575 nm (red). Their sensitivity ranges

overlap to provide continuous (but not linear) vision throughout the visual spectrum. The maximum efficacy is 683 lumens/W at a wavelength of 555 nm (yellow). Scotopic vision is used for vision in the dark and is not applicable in office lighting.

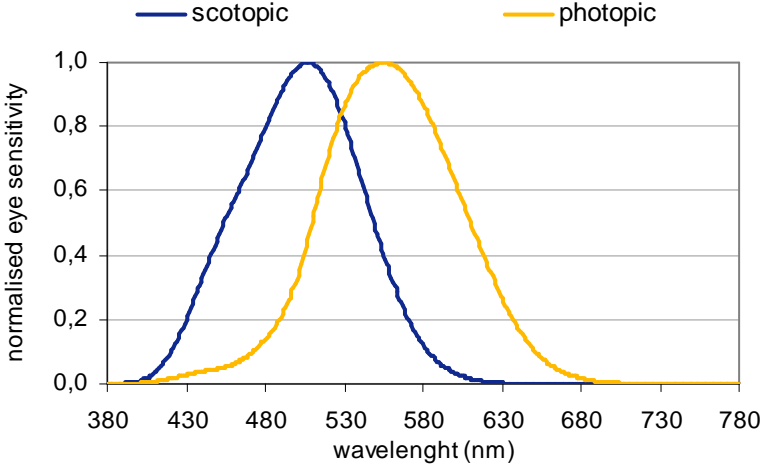

Figure 25: Normalised eye sensitivity for scotopic and photopic vision.

It is important to note that lamp 'efficacy' (lm/W) takes into account the normalised eye sensitivity for photopic vision and that therefore 'lamp efficacy' is not the same as 'lamp efficiency for visible radiation'.

Lamps with a colour spectrum that match the normalised eye sensitivity for photopic vision will therefore have an improved lamp 'efficacy'.

This is illustrated in table 3.1 with lamp efficacy data for identical lamps with different colour spectra. Green lamps have the best fluorescent lamp efficacy but it is obvious that these lamps are not suitable for office work.

To provide an objective indication of the colour rendering properties of a light source the general colour rendering index Ra has been introduced. The maximum value of Ra is 100. This Ra decreases with decreasing colour rendering quality. Lamps with a colour rendering index lower than 80 should not be used in interiors where people work or stay for longer periods according to standard EN 12464.

For office work it is assumed in this study that white lamps are used in compliance with this standard, thus $Ra \geq 80$.

The "colour appearance" of a lamp refers to the apparent colour (chromaticity) of the light emitted. It is quantified by its correlated colour temperature (Table 38).

Table 38: Lamp efficacy for technological similar lamp types with different colour spectra

lamp	'efficacy' $\eta_{lamp}(lm/W)$ (25°C)	colour temperature	Ra
T5 28 W red	75	NA	NA
T5 28 W green	125	NA	NA
T5 28 W blue	25	NA	NA
T5 28W cool daylight (865)	86	6500 K	80..89
T5 28 W white	93	3500 K	80..89

3.2.2 Influence of maintenance factors (LMF, LLMF, RSMF)

Illuminance of office lighting decreases over the period of service, therefore the standard (EN 12646-1) introduces 'maintained illuminance' and maintenance factors (LMF, LLMF, RSMF) should be taken into account (see also definitions in chapter 1).

Research in France (Enertech, 2004) showed that with regard to the “Replacement strategy for fluorescent tubes” only 20% of the premises replace systematically all the tubes of a set of fluorescent lamps when only one of the tubes failed⁵². Only 1 out of the 50 establishments in the sample has a preventive maintenance policy which comprises a systematic replacement of all the fluorescent tubes and starters of this building each year. Furthermore 75% of the investigated establishments systematically replace the starters of the “paves” at each replacement of a tube.

The SAVE report “Market research on the use of energy efficient lighting in the commercial sector” (DEFU, 2001) gathered information on the frequency of inclusion of cleaning of luminaries during maintenance in offices which is presented in Table 28. Only in Spanish offices and private Greek offices, office lighting luminaires are cleaned regularly.

Table 39: Frequency of inclusion of cleaning of luminaries during maintenance

Frequency %		Total number (n)	No	Yes	n/a ⁵³
Belgium	public	277	28,9	0	71,1
Denmark	public	494	2	1	97
	private	208	14	24	63
Spain	public	144	12,5	74,3	13,2
	private	122	8,2	69,7	22,1
Greece	public	354	92,9	1,4	5,7
	private	246	42,3	45,5	12,2
Italy	public	257	0	0	100
	private	348	60	19	21
UK	Public/private	50	100	0	0

The previous data are included for information and can be used for evaluating future implementing measures related to maintenance strategies.

Maintenance factors for indoor electric lighting systems are defined in technical report CIE 97 (2005), they are:

$$MF = LLMF \times LMF \times RSMF$$

where,

MF is the Maintenance factor

LLMF is the lamp lumen maintenance factor;

LMF is the luminaire maintenance factor;

RSMF is the room surface maintenance factor;

⁵² 80% thus only replaced the tube that failed

⁵³ No answer

Spot replacement when a lamp is broken is assumed in this study.

The Luminaire Maintenance Factor (LMF) (see also chapt. 1), Lamp Survival Factor (LSF) (see also chapt. 1), Lamp Lumen Maintenance Factor (LLMF) (see also chapt. 1) and RSMF (Room Surface Maintenance Factor) are related to the maintenance cycle of existing installations (CIE 97(2005)).

High maintenance factors are beneficial and can be achieved by careful choice of equipment and electing to clean the installation more frequently. ISO 8995/CIE S 008-2001 recommends selecting solutions so that the maintenance factor does not fall below 0,7.

For office surfaces a regular cleaning cycle at least two times per year is assumed resulting in a RSMF =0.96 for category A1 and = 0.93 for category A2 luminaires (CIE97(2005)) table 3.6&3.7 with the typical 0.7/0.5/0.2 reflectance's) .

For luminaires, a regular cleaning and inspection cycle (maintenance period) of two years is assumed with the Clean (C) cleanliness category conform the CIE 97(2005) guideline. Luminaire types are assessed according to table 2.2 defined in CIE 97(2005) resulting in type C for category A1 luminaires and type B for category A2. Please note that type D (IP2X) luminaires also exists for office applications but this type will not be taken by default into account in this study but as BAT in chapter 6. These types result in LMF = 0.8 for category A1 and LMF =0.84 for category A2.

LSF and LLMF values are based on data supplied by ELC. Please note also that from these data it can be deducted that CFL lamps are not recommended for office lighting applications because of the short lamp life. Please note that it is always advisable to consult manufacturers for up-to date lamp data. Please note as already stated in CIE 97, there are large quality differences between products on the market. The values stated are for high quality products, with a rated life time of 15000 hours.

The CIE 97 data is commonly used during the design of new lighting installations and will be used for assessing the performance of the Base case in chapter 5 and later.

Summary of data:

Table 40: RSMF and LMF values used in this study

	category A1	category A2
RSMF	0.96	0.93
LMF	0.8	0.84
Group lamp replacement time on magnetic ballast [y]	6	6
Group lamp replacement time on electronic ballast [y]	8	8
maintenance period [y]	2	2

Table 41: LLMF and LSF data for selected lamps

Burning hours		10000 h	15000 h	20000 h
FL triphosphor on magn. ballast	LLMF	0.9	0.9	
	LSF	0.98	0.5	
FL triphosphor on electronic ballast (preheat)	LLMF	0.9	0.9	0.9
	LSF	0.98	0.94	0.5
FL halo phosphate on magn. ballast	LLMF	0.79	0.75	
	LSF	0.82	0.5	
CFLni on magn. ballast	LLMF	0.85		
	LSF	0.5		
CFLni on electronic ballast (preheat)	LLMF	0,9	0,85	
	LSF	0,95	0,5	

source: data supplied by ELC (2006 and 2007) & adapted CIE 97 (2006)

3.2.3 User influence on switching schemes (annual operating time)

User influence on final lighting energy consumption is for a large part a result of the light installation reacting on the presence or absence of the user. Several switching schemes are possible, which allow the installation to reduce the lighting intensity or even to switch the installation completely off during absence of the user. Absence of the user is therefore the first important factor to define the effect of different switching schemes on the final energy consumption. :

Different light switching schemes allow to users to interfere directly or indirectly according to their presence. In reality, the amount of available switching schemes is very large. In every type refinements are possible and often combinations of different types are required to obtain a suitable solution for one specific building. These refinements do have an influence on the energy efficiency of the installation. However generalisations are necessary for this study, and available switching schemes have been grouped in the following large types.

- Centralised control : All lighting in the building is centrally switched on and off. This scheme gives hardly any interference with presence of the building users.
- Manual control : This scheme allows the users to switch on the light at arrival and to switch it off on departure. Acceptable interference is possible as long as the controlled areas by the switches remain small enough. prEN-15193-1 gives a distinction below and above 30m² controlled area per switch. This is for all areas except meeting rooms.
- Manual control and automatic sweep : The automatic sweep adds additional programming of automatic sweeps, and switches off centrally all lights in the evening, avoiding some lights to remain active during the night.
- Presence detection : Similarly to manual control, the effectiveness of presence detection is largely influenced by the area which it controls. A mark of 30 m² per controlled area is again defined to distinguish 'small' and 'larger' office areas.
- Manual control + presence detection to switch off : in this scheme the presence detection is only used to switch off the lights 5 minutes after the last presence detection.

Most commercially available switching schemes can be inserted in one of the described types. The following table gives absence factors for these different schemes for the specific office areas, according to prEN15193-1. The factor F_{oc} is the occupancy dependency factor relating the installed power to the occupancy period.

Table 42: Typical occupancy dependency factors (F_{oc}) (source: prEN15193-1 table D1)

Systems without automatic presence or absence detection	F_{oc}
Manual On / Off Switch	1,00
Manual On / Off Switch + additional automatic sweeping extinction signal	0,95
Systems with automatic presence and/or absence detection	F_{oc}
Auto On / Dimmed	0,95
Auto On / Auto Off	0,90
Manual On / Dimmed	0,90
Manual On / Auto Off	0,80

For the scope of this report, very few distinctions can be made on appliance level. Most distinctions are a result of different components and different lay-out of the entire lighting installation.

Some luminaire types however do incorporate a presence sensor and are able to switch on or off according to presence in the vicinity of the appliance. However these units are not frequently used for office spaces or meeting rooms. These are rather used for smaller areas with higher absence rates, such as toilets, small corridors or technical rooms.

Installations to respond to absence in offices often make use of dimming capacities of the luminaire. For instance, centralised automatic sweeps in offices can switch off all light in the office after working hours, but they can also diminish the lighting intensity to 10 or 20% for the entire area. This responds to a general demand of users to avoid completely dark offices. Incorporation of dimming capacity in the absence control can therefore influence largely the energy-efficiency of the installation. In open space offices it is assumed that presence detection is always performed by dimming in order not to disturb occupants in other areas. Dimming is therefore taken into account by the BGF factor for open plan offices (see definition below).

The operating time is divided between 2250 hours during daylight and 250 hours during night time in accordance with the default annual operating hours prEN15193-1 Annex G with $t_0 = t_d + t_n$. Together the factor F_{oc} the annual operating hours ($t_{operating}$) can be calculated (see table below).

Parameter introduced in this study:

Ballast Gain Factor (BGF): defined as the correction factor (≥ 1) for power consumption ($P_{new}(W) = P_{old}(W)/BGF$).

Summary of data:

Table 43: Operating hours used in this study

	cellular office			open space office	
	manual	auto on/auto off with presence detection	manual on/auto off with presence detection	central	presence detection with dimming
$t_{\text{operating}}$ (h/y)	2500	2250	2000	2500	2500
BGF	1	1	1	1	1.11 (1/0.9)

3.2.4 External factors influencing energy consumption during real use

The performance parameters defined in chapter 1 are obtained under standard test conditions. Photometric data is obtained under test conditions specified in standard CIE 121-1996 on 'The Photometry and Goniophotometry of Luminaires'. An important parameter that can deviate in real life is temperature, the default test temperature is 25 °C.

Electrical data (e.g. power, ..) is obtained under test conditions specified in standard EN 60598-1: 2004 on 'Luminaires. General requirements and tests'. An important parameter that can deviate in real life is line voltage, the default line voltage in EU 25 is 230 VAC with an exception for the UK (240 VAC).

Hereafter we will discuss four factors that can influencing energy consumption of luminaires in real life, they are: temperature, line voltage, lamp voltage and a power factor compensation capacitor aging. Also poor power quality can waste energy (Topalis (1993)) and the capacity of an electrical distribution system, it can harm both the electrical distribution system and devices operating on the system (LRC (1995)). Poor power quality can be caused by lighting equipment when the power factor is low or when they cause harmonic current distortion ((Topalis (1993)). It is important to realise that electronic ballast with electrical power levels >25 Watt are far less insensitive to these influences and therefore a compensation factor will be introduced in this study.

Temperature:

Lamp efficacy and hence power consumption of fluorescent lamps are influenced by temperature (Figure 27, Figure 28).

The physical background⁵⁴ is that T5/Ø 16 mm-fluorescent lamps HE and HO are designed to have their maximum lumen output at 35 °C (compared to 25 °C for T8/Ø 26 mm). For T5/Ø 16 mm-fluorescent lamps the so-called cold spot (the point where mercury condensates in a discharge tube, stamped end of the lamp) is located behind the electrode (Figure 26) which means near the source of heat. The value of the luminous flux at the ambient temperature of 35 °C is only informative for the luminaire manufacturer. Significant is the value of the cold spot temperature. This value is measured at the socket of the stamped side, approx. in a distance of

⁵⁴ OSRAM(2005) 'ECG for T5 fluorescent lamps-Technical Guideline', May 2005.

2 mm of the glass. For an optimized luminous flux this value should be between 45 °C and 50 °C.

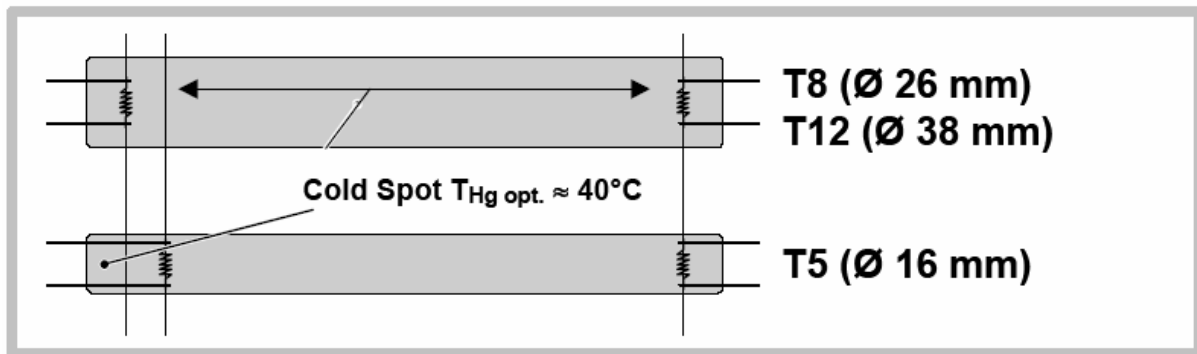

Figure 26 Cold spot location for LFL T5 and T8 lamps⁵⁵

As with fluorescent lamps in general, the rated luminous flux for T5 HE and T5 HO fluorescent lamps is specified at 25 °C, and T5 HE and T5 HO achieve their maximum luminous flux at temperatures between 34 and 38 °C (Figure 28). One of the advantages of T5 lamps is therefore an increased luminaire efficiency (LOR).

In this study for office lighting we assume the appropriate constant environmental temperature. It should be noted that rarely problems can occur when T5 fluorescent lamps are installed in the cool air flow of air-conditioning installation but it is assumed that these problems can be solved easily at installation level.

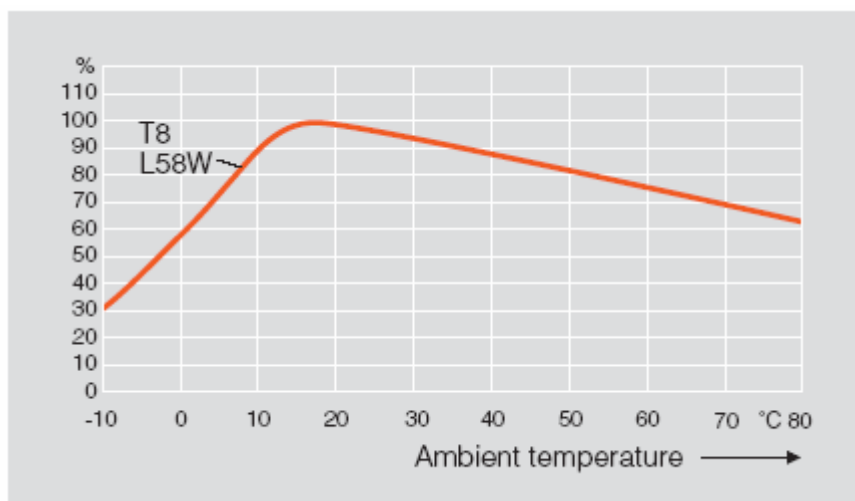

Figure 27: Luminous flux of T8 LFL in function of ambient temperatures⁵⁶

⁵⁵ OSRAM(2005) 'ECG for T5 fluorescent lamps-Technical Guideline', May 2005.

⁵⁶ OSRAM catalogue 2006-2007.

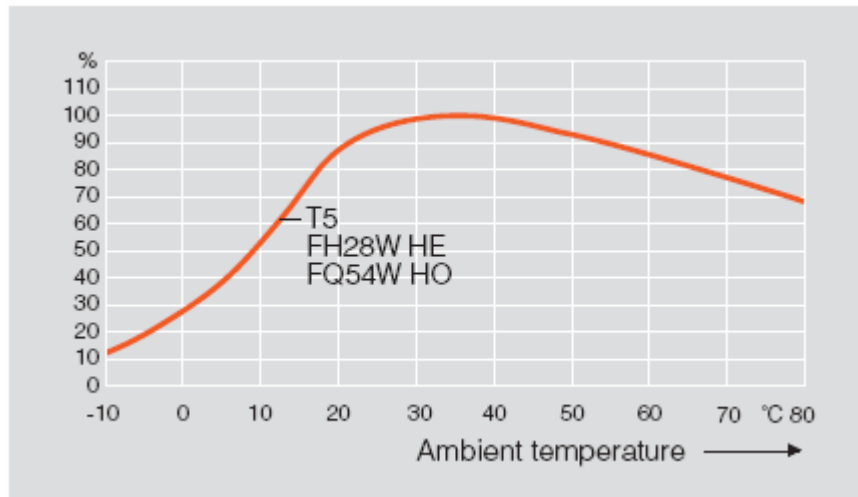

Figure 28: Luminous flux of T5 LFL in function of ambient temperatures⁵⁷

Line voltage:

Power consumption and light output of gas discharge lamps vary with line voltage when a magnetic ballast is used, typical +/- 20 % power variation with +/- 10 % variation of line voltage. Line voltage variations of +/- 10 % are not exceptional in the public grid and are standard allowed (only low cost electronic ballasts don't have this feature (see chapter 6)). Electronic ballasts used in office lighting can overcome this problem. They incorporate electronic Power Factor Compensation(PFC) circuits that needs to be used for power levels above 25 W in order to satisfy standard EN 61000-3-2 (Basu (2004)). The most currently used active electronic PFC topologies are independent of the line voltage (Garcia (2003)).

Lamp voltage:

Power consumption and light output of gas discharge lamps vary also with lamp voltage when a magnetic ballast is used. Lamp voltage can vary with production variations and generally increases with aging. Some electronic ballasts have an internal power control loop and are independent of the lamp voltage, they even detect 'end-of-life' when lamp voltage becomes excessive.

Low Power factor:

The power factor of an AC electric power system is defined as the ratio of the real power to the apparent power and is a number between 0 and 1. Real power is the capacity of the circuit for performing work in a particular time. Apparent power includes the reactive power that utilities need to distribute even when it accomplishes no useful work. Low-power-factor loads increase losses in a power distribution system and result in increased energy costs (LRC (1995)). There is no direct limitation on power factor of luminaires at product level. However many power distribution companies have penalties for large consumers when the total power factor is below 0.8. Therefore many luminaire manufacturers incorporate this feature in luminaires. This feature is always incorporated in electronic ballasts with power levels above 25 W, because an active power factor compensation (PFC) circuit is needed in order to satisfy the harmonic current limits of standard EN 61000-3-2 (Basu (2004)). By consequence electronic ballasts with power factor compensation (all above 25 W) do outperform magnetic ballasts.

⁵⁷ OSRAM catalogue 2006-2007.

Power factor compensation and capacitor ageing:

Power factor compensation capacitors are used with magnetic ballasts. The capacitance decreases with capacitor age. Poor performance of this capacitor is causing an increase of useless currents in the distribution grid and additional power losses in this distribution grid. According to an actual study (ADEME (2006)) 9% additional energy loss can be caused in the distribution grid by aged power factor capacitors.

High level of harmonic line currents:

Discharge lamps are causing harmonic currents that cannot be compensated in magnetic ballasts (chang (1993)), the level of harmonic current on the line voltage with magnetic ballast can vary from 8 to 13 %. Especially third harmonic currents (limited by EN 61000-3-2) can cause increased magnetic losses in distribution transformers (LRC (1995), Topalis (1993)) and in the neutral wire (IESNA (1995), p. 215). Electronic ballast with pure sine wave electronic power factor correctors (PFC) circuits do overcome this problem (Basu (2004)). This feature is always incorporated in electronic ballasts with power levels above 25 W, because an active Power Factor Compensation (PFC) circuit is needed in order to satisfy the harmonic current limits of standard EN 61000-3-2 (Basu (2004)). By consequence electronic ballasts with power factor compensation (all above 25 W) do outperform magnetic ballasts.

Parameter (see definition in chapter 1):

BMF: Ballast Maintenance Factor

Applicable parameter values:

A power level of 25 W or above is most likely for the products within the scope of this study, therefore a clear advantage will be given to electronic ballasts compared to magnetic ballasts (see Table 44 that takes into consideration the benefits related to improved power factor and lower harmonic current content. Moreover electronic ballasts are less sensitive to line and lamp voltage variations.

Table 44: BMF values for power factor and harmonic current related losses used in this study.

	cat. A		cat. B		cat. C	
	magnetic ballast	electronic ballast	magnetic ballast	electronic ballast	magnetic ballast	electronic ballast
BMF	0.95	1	0.95	1	0.95	1

3.3 End-of Life behaviour related to consumers

In most European countries where specific waste legislation is in force (WEEE) an infrastructure is in operation regarding the separate collection and recycling of EoL mercury containing gas discharge lamps. This has been endorsed strongly by lamp industry (source: ELC federation).

Table 45 : Countries with a recycling infrastructure for EoL gas discharge lamps in Europe

Lamp Types	End User	With Infrastructure ⁵⁸	Without Infrastructure ⁵⁹
GAS DISCHARGE LAMPS	Professional Belgium	Austria Denmark France ² Germany Netherlands Nordic countries Spain ² Switzerland United Kingdom ²	Rest of Europe
	Household	Austria ² Belgium ² Denmark Germany Netherlands Norway Switzerland	Rest of Europe

Recycling techniques for fluorescent lamps

Basically two types of techniques are utilised for recycling of EoL fluorescent lamps. One technique is known as "end cut", employing a process by which both ends of the fluorescent tube are removed before the materials are separated and processed to a high purity product. The other technique is known as "shredder (crush and sieve)". It crushes the complete product, after which the various ingredients are separated and processed. All the recovered material can be re-used in different types of applications. In the table below an overview is given of the material fractions and their outlet channels (customers). For many fractions the customer is the lamp manufacturer. The lamp manufacturer uses these material fractions to substitute for the virgin material and by doing so closes the life cycle loop.

Table 46: Overview of recovered materials and their customers

Materials	Customer
Glass	Lamp industry Glass industry Glass bricks/concrete bricks
Metal Alu-cap Brass Fluorescent powder, glass powder (mercury containing or mercury-free)	Lamp industry Controlled landfill
Mercury after distillation	Mercury industry Lamp industry

Luminaires and ballasts contain high amount of aluminium, steel and copper. The prices offered for used materials are actually quite high (e.g. many copper wiring and tube thefts occur nowadays on deserted building sites at night). We assume therefore that these are recycled too.

⁵⁸ Countries are included here if sufficient capacity is available to recycle at least 50% of the EoL lamps

⁵⁹ Starting Scheme

3.4 Local infra-structure and facilities

3.4.1 Influence of local infrastructure on the lighting installation

Office room area size and light point location

Local infrastructure and room design can have a large effect on the efficiency of lighting installations. Office zone lay-out can influence lighting design, e.g. individual or cellular offices allow more dimming options for energy saving compared to open plan offices with cubicles. Also the reflection of walls is larger in cellular offices compared to open plan offices. In order to analyse this influence typical room types of rooms are been defined in this study: a cellular office and an open plan office.

Tables below also include the room index (k) parameter that is used in standard EN 13032-2 for simple photometric calculations:

$$k = LxB/(hx(L+B))$$

where,

L = Room length

B= room width

h = distance between the luminaire and the working plane.

Typical dimension of small office room or *cellular office*:

A cellular office is often between 18m² and 30 m² (Neufert(2000), FGL Heft 4). Several administrations specify net available surfaces for each office worker. Architectural standards take 10 to 15 m² per office worker into account. Usually multiples of 60 cm are used in order to fit with floor and ceiling tiles. The Belgian administration sets forward a limit of 12 m² per office worker.

For a standard room size, 19.44 m² seems therefore very reasonable. The assumed height is based on architectural standards used in buildings from 1970 on to this moment. The net height between ceiling and floor is often 2.8 m. In older buildings, this height is quite often higher. However, new project developments focus on a maximum number of building floors for economic reasons and therefore a ceiling height of 2.8m is considered representative.

Applicable parameter values in this study:

Table 47: Office dimensions for cellular offices used in this study.

L (m)	5,4
B (m) (one side has window)	3,6
window height(m)	2
h (m)	2 (=2,8-0,8)
k	1,08

Typical dimension of a large office room or open plan office:

In this study also an open plan office will be evaluated. Open plan offices are being used by groups of 10 to 30 office workers. Open plan office dimensions are therefore chosen by multiplying the dimensions of the cellular by a factor 3 but with a window at the longest side. Generally, in these offices it is beneficial to use a little increased ceiling height in order not to create a very shallow impression, therefore an office ceiling height of 3 meter was chosen.

Applicable parameter values in this study:

Table 48: Office dimensions for open plan offices used in this study.

L (m) (one side has window)	16,2
B (m)	10,8
window height(m)	2
h (m)	2,2 (=3 - 0,8)
k	2,94

Typical office room surface reflection

The room surface reflection has also an influence on the illumination of the task area. The most common default or typical room reflectance values (FGL Heft 4, ZVEI guide(2005)) are included in the table below, they can be used for photometric calculations.

The exact surface reflection is not always known during the design of the installation and can also modify during use, therefore the default values are commonly used in photometric calculations. But this can lead to over or under dimensioning in rooms with bright or dark surfaces, therefore these extreme values are also included. It is important to note that products that are adaptable to variable room reflectance conditions by including dimming ballasts can tune the illumination level close to the minimum required. The corresponding energy saving for these products will be assessed later in this study (chapter 6). Table 50 includes the typical values defined in standard SIA 380-4, they are somewhat more dark and less bright.

Applicable parameter values in this study (see chapter 3):

Table 49: Reflectance values used in this study.

	very bright	typical (default)	very dark
Reflectance ceiling	0.9	0.7	0.5
Reflectance wall	0.8	0.5	0.3
Reflectance floor cavity	0.4	0.2	0.2

Table 50: Reflectance values used in SIA 380-4.

	very bright	typical (default)	very dark
Reflectance ceiling	0.8	0.7	0.3
Reflectance wall	0.5	0.5	0.3
Reflectance floor cavity	0.3	0.2	0.1

Typical office room daylight zone

The use of daylight can also contribute significantly to energy savings, therefore the daylight zone can be calculated from the room dimensions and local conditions.

Reference daylight dimming factors are based on prEN15193-1.

The maximum depth of the daylight area can be calculated according to formula (C.2 prEN15193-1):

For the reference cellular office:

$$a_{D,max} = 2.5 \times (2.8 - 0.8) = 5 \text{ m}$$

For the reference open plan office:

$$a_{D,max} = 2.5 \times (3 - 0.8) = 5.5 \text{ m}$$

The exact calculation of daylight savings is much related to local weather conditions and the building constructions. For reasons of simplifications, the following efficiencies of daylight will be used in this study. These values are applied for the complete cellular office and half the open plan office. Therefore it is assumed that in an open plan office only half In the scope of this study, both the effect on building level and the effect on appliance level can be of interest. Simplified values from standard prEN15193-1 are used (FD) for an average EU latitude location (Frankfurt) for automatic daylight responsive dimming systems. Finally this values is corrected because the luminous efficacy of the lamp-ballast combination at reduced light output is lower (Roisin (2007)) by 0.87 (70(@50 % luminous flux)/80(@full power)).

Applicable parameter values in this study:

Table 51: BGF values for daylight savings used in this study.

	Efficiency of daylight responsive dimming in the daylight zone (FD = (1 - FDSx FDC)	Luminaires with daylight responsive dimming (%)	BGF	Luminaires with daylight responsive dimming (%)	BGF
		Cellular office		Open plan office	
Automatic daylight dependent dimming	0,56 ((1-0,66x0,77)/0.87)	100	1.77	50	1.38

3.4.2 Influence on the number of lamps per ballast

Luminaires are sold with up to 4 lamps (Figure 29). The main motivation is to obtain a more compact (rectangular) designs that improve ceiling and building integration. For luminaires with more then one lamp electronic control gear is especially attractive and cost effective because one control gear can easy supply several lamps. Most wattage of fluourescent lamps operated on conventional magnetic ballast need one ballast per lamp.



Figure 29: Luminaires fitted with 3 lamps (left) and 1 lamp (right)

Therefore the 'Light Point Index' (CELMA (2003)) can be used:

'Light Point Index = LPI = Number of lamps per control gear

The following values can be used based on market behaviour(CELMA (2003):

Table 52: LPI values

control gear type	LPI
electronic ballast	1.7
magnetic ballast	1.1

3.4.3 Impact of the over dimensioning of the task area relative to the surrounding area in real circumstances

The standard EN 12464-1 requires that 'for places where the size and/or location of the task area is unknown, the area where the task might occur shall be taken as the task area' while illuminance requirements for the surrounding area in office lighting are only 300 lx compared to 500 lx for the task area.

By consequence energy can be saved by providing dimming capabilities to luminaires in order to adapt in the use to the exact office desk location.

The following parameter can be used in the assumption that 1/3 of the area can be dimmed from 500 to 300 lx: $BGF = 1/(1-0.33 \times 200/500) = 1/0.87 = 1.15$.

Applicable parameter values in this study:

Table 53: BGF values for fine tuning the task area

	Luminaires with dimming	Luminaires without dimming
BGF	1.15	1

3.4.4 Lack of interest by the office building owner

As stated in the definition, the 'building owner' can interface with many types of subcontractors. A simple overview of 'metrics for defining success' related to the contractor or subcontractor is in table 3.2. All actors will try to influence the 'building owner' and motivation can therefore be very diverse. Finally, the lighting designer (if involved) needs to look for a compromising solution and best fitting products. From the table it is also clear that there are much more factors involved than energy efficiency alone.

Table 54: Compromising motivating factors of the 'putting into service consumer'

subcontractor/contractor	performance metric
Building developers*	euro per square meter
Electrical engineers*	Watt per square meter, code compliance
Lighting engineers*	illuminance, quality of light
Construction managers*	Planning and specifications/adherence to drawings
Contractors*	Budget and schedule (no call-backs)
Suppliers*	Sales and margins
Construction workers*	Signoff
Leasing agents*	Quick rental; euro per square meter
Building operators*	Simple payback
Maintenance staff*	Complaints
Architects**	Creative expression, Pride, Profit
Utility DSM (Demand Side Management) staff*	Euro per avoided kilowatt and kilowatt-hour

* Adapted from Energy Efficient Buildings: Institutional Barriers and Opportunities by E-Source, Inc., 1992

** Adapted from Commercial and Industrial Lighting Study by Xenergy, Inc., 2000

3.4.5 Lack of knowledge or skilled subcontractors

The proliferation of more advanced lighting energy saving techniques can require additional skills that are not available by the various service providers (see §3.1) involved in the installation process and can form a market barrier.

For example, free available lighting design software lowered the technical barrier for lighting design without basic knowledge about lighting fundamentals and awareness about realistic lighting system performance. By consequence, there can be sometimes too much reliance on outputs of lighting software without scrutiny of the results.

Also complex lighting energy saving techniques where office or building lay out interacts (e.g. day lighting, presence detection, indirect lighting) could suffer from this lack of knowledge in the office design stage.

3.4.6 Lack of user acceptance for automatic control systems

It is important to take 'user acceptance' into account especially with automatic control systems. For example, experiences with complex daylight responsive control systems show that problems may occur when users do not know the purpose or how it works (IEA task 21

(2001)). These problems can vary from complaints to completely overruling of the system through sabotage, which may lead to reduced energy saving.

4 TECHNICAL ANALYSIS EXISTING PRODUCTS

This task is a general technical analysis of current products on the EU-market and provides general inputs for the definition of the Base case (chapter 5) as well as the identification of part of the improvement potential (chapter 7), i.e. the part that relates to better performing products on the market.

4.1 Production phase

4.1.1 Introduction

The table below summarizes the types of lamps, gear and luminaires that are taken into account as most relevant for office lighting. This list is based on the types of lamps and control gear that are currently installed in European offices and the types that are expected to be installed in the near future.

Please note that representative lamps and luminaires were selected after the analysis of the use phase. The catalogues contain a multitude of lamps and luminaires for various, also non-office applications; for reasons of simplification only selected representative products that fulfil the requirements of the use phase are included in this study.

Selected BOM fluorescent lamps:

Table 55: Overview of selected lamps⁶⁰

Lamp type	Wattage W	Ø mm	Colour Temp K	Colour rend Ra	Fluorescent coating	Perform indic	ILCOS-code
Linear fluorescent T8	36	26	4000	80≤Ra<90	tri-phosphor		FD-36/40/1B-E-G13-26/1200
Linear fluorescent T8	18	26	4000	80≤Ra<90	tri-phosphor		FD-18/40/1B-E-G13-26/590
Linear fluorescent T5	28	16	4000	80≤Ra<90	tri-phosphor	HE	FDH-28/40/1B-L/P-G5-16/1149
Linear fluorescent T5	14	16	4000	80≤Ra<90	tri-phosphor	HE	FDH-14/40/1B-L/P-G5-16/549
Linear fluorescent T5	54	16	4000	80≤Ra<90	tri-phosphor	HO	FDH-54/40/1B-L/P-G5-16/1149

⁶⁰ Compact fluorescent lamps (CFLni) with 2G11 socket are mostly used where design or available space play a part. They are considered in this study but they are not selected as a base case.

Selected BOM fluorescent ballasts:

Magnetic ballasts+ capacitor+starter:

Linear FL T8-36W (ILCOS FD-36-E-G13-26/1200) class EEI=B2 + 4.5 μ F cap + starter
Linear FL T8-36W (ILCOS FD-36-E-G13-26/1200) class EEI=B1 + 4.5 μ F cap + starter
Linear FL T8-18W (ILCOS FD-18-E-G13-26/600) class EEI=B2 + 4.5 μ F cap + starter
Linear FL T8-18W (ILCOS FD-18-E-G13-26/600) class EEI=B1 + 4.5 μ F cap + starter

Electronic ballasts:

2 x Linear FL T8-36W (ILCOS FD-36-E-G13-26/1200) electronic ballast class EEI=A2
3 x Linear FL T8-18W (ILCOS FD-18-E-G13-26/600) electronic ballast class EEI = A2
2 x Linear FL T5-28W HE (ILCOS FDH-28-G5-L/P-1150) electronic ballast class EEI=A2
3 x Linear FL T5-14W HE (ILCOS FDH-14-G5-L/P-550) electronic ballast class EEI=A2
1 x Linear FL T5-54W HO (ILCOS FDH-54-G5-L/P-1150) electronic ballast class EEI=A2
2 x Linear FL T8-36W (ILCOS FD-36-E-G13-26/1200) electronic ballast class EEI=A1
2 x Linear FL T8-36W (ILCOS FD-36-E-G13-26/1200) electronic ballast class EEI=A3

Selected BOM luminaires:

Ceiling mounted (category A1):

1 x Linear FL T8-36W (ILCOS FD-36-E-G13-26/1200) bare batten
2 x Linear FL T8-36W (ILCOS FD-36-E-G13-26/1200) closed top housing reflector
2 x Linear FL T8-36W (ILCOS FD-36-E-G13-26/1200) enclosed IP2X refractor
2 x Linear FL T5-28W HE (ILCOS FDH-28-G5-L/P-1150) closed top housing reflector
3 x Linear FL T8-18W (ILCOS FD-18-E-G13-26/600) closed top housing reflector
3 x Linear FL T5-14W HE (ILCOS FDH-14-G5-L/P-550) closed top housing reflector

Suspended with direct/indirect light (category A2):

2 x Linear FL T5-28W (ILCOS FDH-28-G5-L/P-1150) open top housing reflector
1 x Linear FL T5-54W HO (ILCOS FDH-54-G5-L/P-1150) open top housing reflector

For these typical lamps, gear and luminaires product data are collected as needed for the VHK model. The production phase is modelled according to the MEEUP methodology report. Detailed information on environmental impact is included in chapter 3 of this MEEUP methodology report. This method focuses on seven environmental impact parameters (Total Gross Energy Requirement, Electricity, Feedstock energy (for plastics only), Process Water, Cooling Water, Hazardous Solid Waste, Non-Hazardous Waste). This method satisfies the requirement set out in article 15 paragraph 4 (a) of the eco-design directive (2005/32/EC): 'Considering the life cycle of the EuP and all its significant environmental aspects, inter alia energy efficiency, the depth of analysis of environmental aspects and of the feasibility of their improvement shall be proportionate to their significance. The adoption of eco-design requirements on the significant environmental aspects of an EuP shall not be unduly delayed by uncertainties to regarding the other aspects'. In order to satisfy these requirements the most relevant products were chosen and sometimes an available similar process or material (based

on physical or chemical similarity) is used when it is not directly available in the MEEUP methodology. These requirements allow often to follow a simple and straightforward approach.

Mercury is an essential element for the operation of fluorescent lamps and is inserted during the production phase. In normal circumstances, mercury stays within the lamp enclosure during its entire lifetime and can be recycled at end of life (see section 3.3). It should be noted that also during use phase mercury is released to the atmosphere due to the electricity production (see MEEUP methodology table 29 parameter HM p. 88). In chapter 5, Figure 43 it will be demonstrated that the use phase is therefore far more significant. Total lamp mercury is calculated separately in the related Eco-Reports.

In this study types of lamp and control gear were chosen within a certain range of weight of components and a range of power (except for the starter). This range will allow also the assessment of aberrations on the potential environmental impact of other lamp, luminaire and ballast components. But here again, one can expect a very low total environmental impact for lighting by the 'production phase' according to the case study that was carried out together with the elaboration of the MEEUP methodology.

The different parts (lamp, gear and luminaire) are analyzed on part-level, independent from each other. The results of this assessment on part-level serve as input for the assessment of the base case, which is discussed in the next chapter.

Producers were requested to provide data on BOMs in an early stage of the project, but no data have been received. Therefore other sources of information are used. The Bills of Materials for the respective products (lamps, gear and luminaires) have been composed based on information retrieved from literature, actual product examples and on the other hand data from producers catalogues. If relevant and possible, data sets from different sources are checked on their consistency.

The BOM is used as input for modelling the production phase in the VHK-model. The input tables are included in the following paragraphs. For the discussion of the end-of-life phase is referred to par. 4.2.6.

4.1.2 Lamps production

Data on weight of the lamps that are summarized in Table 55 are gathered in literature, by means of measurements of actual product examples and in catalogues of different suppliers. From this data range on weight of lamps the worst-case (i.e. the largest weight) is selected. The material composition for the Linear FL T8-36W and the Linear FL T5-28W lamps is based on data from literature (Hermann C. et al, 2005). Both lamps have a comparable length, which explains the identical material composition (at a rough estimate). It is also the basis for the material composition of the other lamps, for which the absolute weight of the metals and the mercury remains unchanged while the absolute weight of the glass and the residual materials depends on the length of the lamp.

The MEEUP database on environmental. Impacts

Some remarks about the environmental impacts related to this input table:

- The environmental impacts of the residual rare earth metals is assumed negligible.
- The environmental impact of the noble filling gasses is assumed negligible (argon or krypton). A noble gas is chemically inert and therefore not a hazardous gas.

Carbondioxide emission due to production of 1 kg Argon is only 0.271 kg and for 1 kg Krypton only 102 kg. As can be checked in chapter 5, this is far less than other lamp parts

- For the production of the lamp mercury (0.005g) no detailed data is available on the environmental impact of mercury production itself, but we take the mercury itself as environmental impact (heavy metal) into account-
- Looking at the total weight, the glass is the most important material of the lamp (more than 90wt%).

The following table presents the input data using the terminology from, the VHK model for the environmental assessment.

Table 56: Input data for the materials extraction and production of the lamps (expressed in g)

MATERIALS Extraction & Production Description of component	LFL T8- 36W	LFL T8- 18W	LFL T5- 28W	LFL T5- 14W	LFL T5- 54W	Halophos phate T8 36W	Category	Material or Process
Soda-lime glass	133,00	65,50	99,75	47,90	identical to T5-28W	133,00	7-Misc.	54-Glass for lamps
Aluminium sheet for caps	4,20	4,20	3,15	3,15		4,20	4-Non-ferro	26-Al sheet/extrusion
Residual_rare earth metals	2,80	1,30	2,10	0,95		2,80	5-Coating	
Noble filling gas (to be updated)	2,80	1,30	2,10	0,95		2,80	5-Coating	
Metal Mercury	0,005	0,005	0,005	0,005		0,010		
Total weight	140	71	105	52		140		

More than 98wt% of the materials is modelled, the remaining materials are expected to not have a major environmental impact. So only a minor underestimation of the total environmental impact of the lamp can be expected.

The inputs that refer to the production (manufacturing processes) of the lamps are directly deduced from the input data for the materials extraction and production . No specific significant differences in the production parameters exist among the different lamp types to our knowledge. Following the VHK case study it is taken into account that for the production of 1 kg sheet metal for lamps, 1.25 kg sheet metal is needed as input material (25% sheet metal scrap).

4.1.3 Ballasts (control gear) production

For office lighting both electromagnetic ballasts including a capacitor and starter and electronic ballasts are used and as such analyzed in this study. The environmental assessment is performed for the control gear as a whole, not for the individual subparts. Distinction is made between electromagnetic ballasts and electronic ballasts.

As for the lamps, general data on weight are taken from literature. Specific data are derived from measurements of actual product examples and from suppliers catalogues. The BOM is based on the worst-case weight within the complete data range for a specific ballast. The material composition of the gear is taken from literature (Hermann C. et al, 2005) and is

assumed identical for all types of electromagnetic resp. electronic ballasts, independent of the energy efficiency index and the lamp type and power.

Some remarks with this input table:

- The capacitor (electromagnetic gear) is modelled as 70wt% aluminium sheet and 30wt% epoxy.
- Only the production of the winding insulation paper is not modelled with the VHK-model. This component only represents less than 0.5wt% of the total gear and as such may be neglected.
- For both types of ballasts, the steel sheet is the most important component from the perspective of weight (more than 50%), followed by the copper for the coils.

The following tables present the input data for electromagnetic resp. electronic gear using the terminology from the VHK model for the environmental assessment.

Table 57: Input data for the materials extraction and production of the electromagnetic gear (expressed in g)

MATERIALS Extraction & Production Description of component	Magnetic ballast for LFL T8-36W, EEI=B1	Magnetic ballast for LFL T8-36W, EEI=B2	Magnetic ballast for LFL T8-18W, EEI=B1	Magnetic ballast for LFL T8-18W, EEI=B2	Category	Material or Process
Plastic parts_PA6,6	4,44	3,54	4,44	3,44	2-TecPlastics	11-PA 6
Polyester resin	0,15	0,12	0,15	0,11	2-TecPlastics	14-Epoxy
Connector springs_Brass	1,23	0,98	1,23	0,96	4-Non-ferro	31-CuZn38 cast
Winding insulation_paper	1,97	1,58	1,97	1,53		
Copper wire	89,49	71,38	89,49	69,25	4-Non-ferro	29-Cu wire
Steel sheet_zinc coated	36,29	28,95	36,29	28,08	3-Ferro	21-St sheet galv.
Bottom_Steel sheet	87,89	70,10	87,89	68,01	3-Ferro	21-St sheet galv.
Electrical Steel sheet	572,74	456,83	572,74	443,19	3-Ferro	21-St sheet galv.
Aluminium sheet	3,95	3,15	3,95	3,06	4-Non-ferro	26-Al sheet/extrusion
Starter	11,11	8,86	11,11	8,60	6-Electronics	51-PWB 6 lay 2 kg/m2
Capacitor (4,5 mF)	21,51	17,16	21,51	16,65	4-Non-ferro	26-Al sheet/extrusion
Capacitor (4,5 mF)	9,22	7,35	9,22	7,13	2-TecPlastics	14-Epoxy
Total weight (g)	840	670	840	650		

Table 58: Input data for the materials extraction and production of the electronic ballasts
(expressed in g)

MATERIALS Extraction & Production	Electronic ballast for 2xLFL T8-36W (EEI=A1)	Electronic ballast for 2xLFL T8-36W (EEI=A2)	Electronic ballast for 2xLFL T8-36W (EEI=A3)	Electronic ballast for 3xLFL T8-18W (EEI=A2)	Electronic ballast for 2xLFL T5-28W (EEI=A2)	Electronic ballast for 3xLFL T5-14W (EEI=A2)	Electronic ballast for 1xLFL T5-54W (EEI=A2)	Category	Material or Process
Description of component									
PCB	49,00	34,00	26,80	28,50	31,00	28,50	25,00	6-Electronics	49-PWB 1/2 lay 3.75kg/m2
Housing_Steel sheet	249,90	173,40	136,68	145,35	158,10	145,35	127,50	3-Ferro	21-St sheet galv.
PET film	9,80	6,80	5,36	5,70	6,20	5,70	5,00	1-BlkPlastics	2-HDPE
solder paste	4,90	3,40	2,68	2,85	3,10	2,85	2,50	6-Electronics	52-Solder SnAg4Cu0.5
Coil	137,20	95,20	75,04	79,80	86,80	79,80	70,00	6-Electronics	44-big caps & coils
Metal film capacitor_Aluminium	14,70	10,20	8,04	8,55	9,30	8,55	7,50	4-Non-ferro	26-Al sheet/extrusion
ELKO component_Aluminium sheet	9,80	6,80	5,36	5,70	6,20	5,70	5,00	6-Electronics	44-big caps & coils
luster terminal_PP	7,35	5,10	4,02	4,28	4,65	4,28	3,75	1-BlkPlastics	4-PP
luster terminal_steel	7,35	5,10	4,02	4,28	4,65	4,28	3,75	3-Ferro	22-St tube/profile
Total weight (g)	490	340	268	285	310	285	250		

The inputs that refer to the production (manufacturing processes) of the gear are directly deduced from the input data for the materials extraction and production . No specific significant differences in the production parameters exist among the different types of gear to our knowledge. Following the VHK case study it is taken into account that for the production of 1 kg sheet metal for the gear, 1.25 kg sheet metal is needed as input material (25% sheet metal scrap).

4.1.4 Luminaires production

The luminaires that are selected for the environmental assessment are related to a specific type and number of lamps. The BOMs as discussed here apply for naked luminaires, in other words without the lamps and the gear. As for the lamps and the gear the data on weight of the luminaires are taken from literature, by means of measurements of actual product examples and from suppliers catalogues. In each case the worst-case is taken as the basis for the BOM. The material composition is based on own measurements of dismantled products and is comparable for the different types of luminaires.

Since most ceiling mounted luminaires exist in built-in version as well as in built-up version, the data set that is most reliable is taken as representative. For some luminaires this represents the built-in version, for other it is the built-up version. A survey shows that no significant differences exist between comparable built-in and built-up versions. It is clearly indicated in the tables for which version the data apply.

The following tables presents the input data for the luminaires as they are modelled in the VHK model for the environmental assessment.

Table 59: Input data for the materials extraction and production of the luminaires (expressed in g)

MATERIALS Extraction & Production	Ceiling mounted luminaire 1x LFL T8-36W (bare batten)	Ceiling mounted luminaire 2x LFL T8-36W (closed top housing reflector) built-up	Ceiling mounted luminaire 2x LFL T8-36W (enclosed IP2X reflector) built-up	Ceiling mounted luminaire 3x LFL T8-18W (closed top housing reflector) built-in	Ceiling mounted luminaire 2x LFL T5-28W (closed top housing reflector) built-in	Ceiling mounted luminaire 3x LFL T5-14W HE (closed top housing reflector) built-in	Suspended luminaire 2x LFL T5-28W (direct/indirect)	Suspended luminaire 1x LFL T5-54W (direct/indirect)	Category	Material or Process
Description of component										
Housing_Steelplate	1660,00	4696,00	4696,00	3768,00	4181,20	3475,00	4672,64	2739,13	3-Ferro	21-St sheet galv.
Reflector_Aluminium		1133,00		985,00	1008,80	1117,00	1127,36	660,87	4-Non-ferro	26-Al sheet/extrusion
Reflector_PMMA			2304,00						2-Tec-Plastics	13-PMMA
Reflector plates_Aluminium				213,00		195,00			4-Non-ferro	26-Al sheet/extrusion
Total weight	1660	5829	7000	4966	5190	4787	5800	3400		

The inputs that refer to the production (manufacturing processes) of the luminaires are directly deduced from the input data for the materials extraction and production. No specific significant differences in the production parameters exist among the different types of luminaires to our knowledge. Following the VHK case study, it is taken into account that for the production of 1 kg sheet metal for the luminaire, 1.25 kg sheet metal is needed as input material (25% sheet metal scrap).

4.2 Distribution phase

The environmental impact of the distribution of the lamps, control gear and luminaires is modelled according to the VHK-model. The input parameters for the lamps and control gear are shown in the table below and are assumed almost identical for all lamp types resp. all control gear. The only difference can be found in the volume of the packaged final product, which is based on the dimensions of the respective lamps and gear.

Table 60: Input data for the environmental assessment of the distribution of the lamps and control gear

DISTRIBUTION (incl. Final Assembly)		Answer
Description		
Is it an ICT or Consumer Electronics product <15 kg ?		YES
Is it an installed appliance (e.g. boiler)?		NO
Volume of packaged final product in m ³	in m3	4.6e-6 – 1.08e-5 (lamps) 0.0004-0.00045 (gear)

The input parameters for the distribution phase of the luminaires are also based on the volume of the packaged final product. A difference with the lamps and gear is that the luminaires are considered to be an installed appliance.

Table 61: Input data for the environmental assessment of the distribution of the luminaires

DISTRIBUTION (incl. Final Assembly)		Answer
Description		
Is it an ICT or Consumer Electronics product <15 kg ?		YES
Is it an installed appliance (e.g. boiler)?		YES
Volume of packaged final product in m ³	in m3	0.006-0.063

4.3 Use phase (product)

In this paragraph an overview is included of the calculation of the annual resources consumption and the direct emissions related to the defined performance parameters in chapter

1 and 3 under standard and non standard conditions. This paragraph also includes a representative overview of the performance parameters found for products on the market anno 2006. In chapter 6, dedicated to the Best Available Technology (BAT) and Best Not Yet Available Technology (BNAT), upcoming products are considered with more improved performance parameters but with a high actual price and/or a low actual trade volume or products that are only in the R&D phase.

4.3.1 Rated annual resources consumption (energy, lamps) during product life according to the test standards defined in chapter 1

4.3.1.1 Formulas that relate energy use to equipment performance parameters

The annual energy consumption of a luminaire and lamp in standard conditions is straightforward and related to the lamp power, control gear losses and burning hours per year.

The maximum power consumption (P) per luminaire in operational mode can be calculated from the equipment performance parameters defined in chapter 1:

$$P [W] = P_{lamp} \times N_{la} / \eta_{ballast}$$

Where,

- P_{lamp} and $\eta_{ballast}$ are defined in chapter 1.
- N_{la} = lamps per luminaire

The annual energy consumption (E_y) per luminaire can be calculated:

$$E_y [kWh] = P_{lamp} \times N_{la} / (\eta_{ballast}) \times t_{operating} + P_{ci} \times (8760 - t_{operating})$$

Where,

- $t_{operating}$ = burning hours per year as defined in chapter 3.
- **P_{ci} = The luminaire parasitic power with the lamps off.**

The functional unit (FU) per luminaire as defined in chapter 1 can be calculated from the lamp, ballast and luminaire performance parameters as defined in chapter 1 and 3 following the definition of these parameters:

$$FU [\text{lumen}] = UF \times LMF \times LLMF \times RSMF \times N_{la} \times \Phi_{lamp}$$

Where,

- UF is the utilization factor as defined in chapter 1.
- LMF is the luminaire maintenance factor as defined in chapter 1.
- LLMF is the lamp lumen maintenance factor as defined in chapter 1.
- RSMF is the room surface maintenance factor as defined in chapter 3.

By definition 1 lux equals 1 lumen per m² and therefore the following relationship exists with office task area illuminance requirements as discussed in chapter 1:

$$E [\text{lx}] = \text{FU} / A$$

Where,

- A is the office task area per luminaire (m²) obtained by dividing the total office task area by the number of installed luminaires in this area.

4.3.1.2 Formulas related to lamp and ballast consumption per luminaire

The annual consumption of lamps per luminaire in standard conditions is straightforward and related to the lamp survival factor (LSF) and the time period for group replacement (t_{group}) in years:

$$N_y = (1 / t_{\text{group}} + (1 - \text{LSF}) / t_{\text{group}}) \times N_{\text{la}}$$

Where:

- LSF is defined in chapter 1
- t_{group} is the time for group lamp replacement in years.
- it is assumed that for spot replacement only the broken lamp is replaced even when several lamps are installed in one luminaire.

The annual consumption of ballasts per luminaire in standard conditions (ballast tc point @ 70 °C) will be modelled according to catalogue data (OSRAM catalogue 2006/2007 p. 11.132):

$$N_b = \text{BFR}/100 \times t_{\text{operating}} / 1000\text{h} \times N_{\text{bal}}$$

Where:

- BFR = ballast failure rate per 1000 h with the ballast tc point @ 70 °C.
- N_{bal} = number of ballasts per luminaire.

In this study a BFR of 0.2 % will be used for electronic ballasts (OSRAM catalog 2006/2007 p. 11.132) and 0 % for magnetic ballasts.

4.3.1.3 Assessment of relevant lamp types and product performance parameters

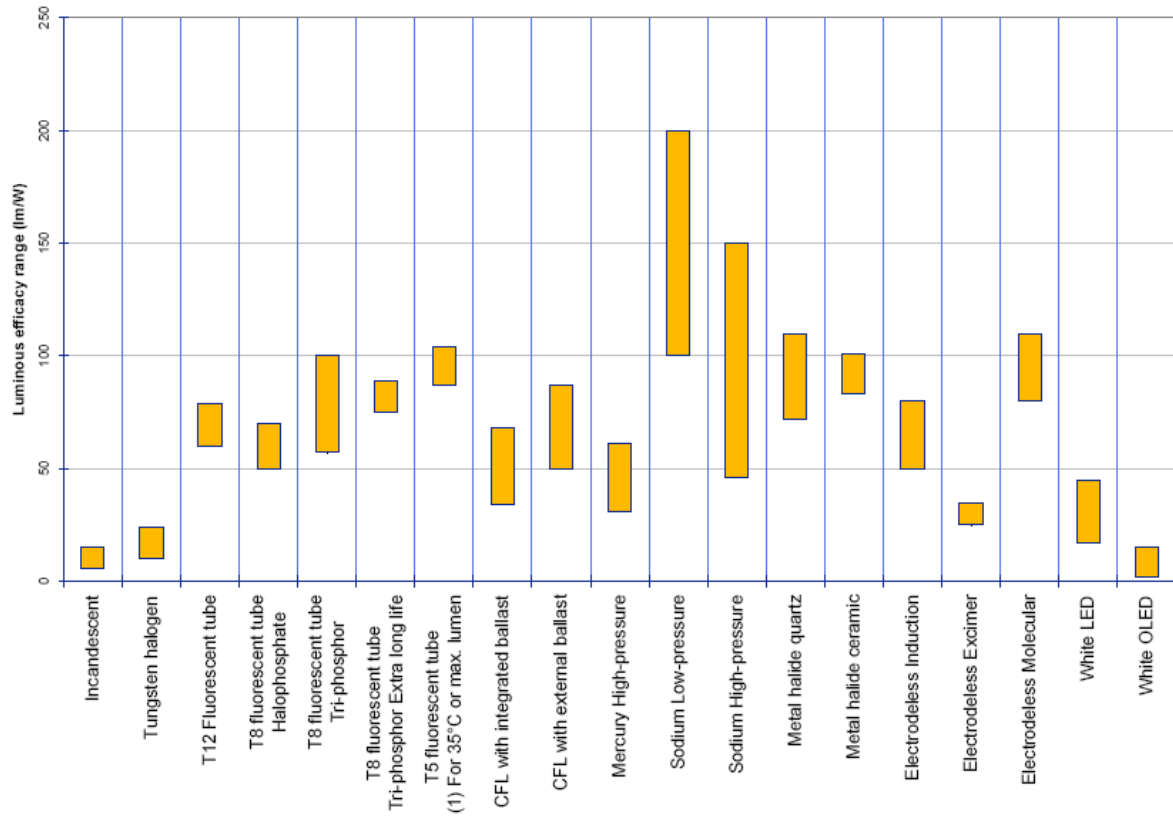

Figure 30: Luminous efficacy range of lamp technology (source: Laborelec)

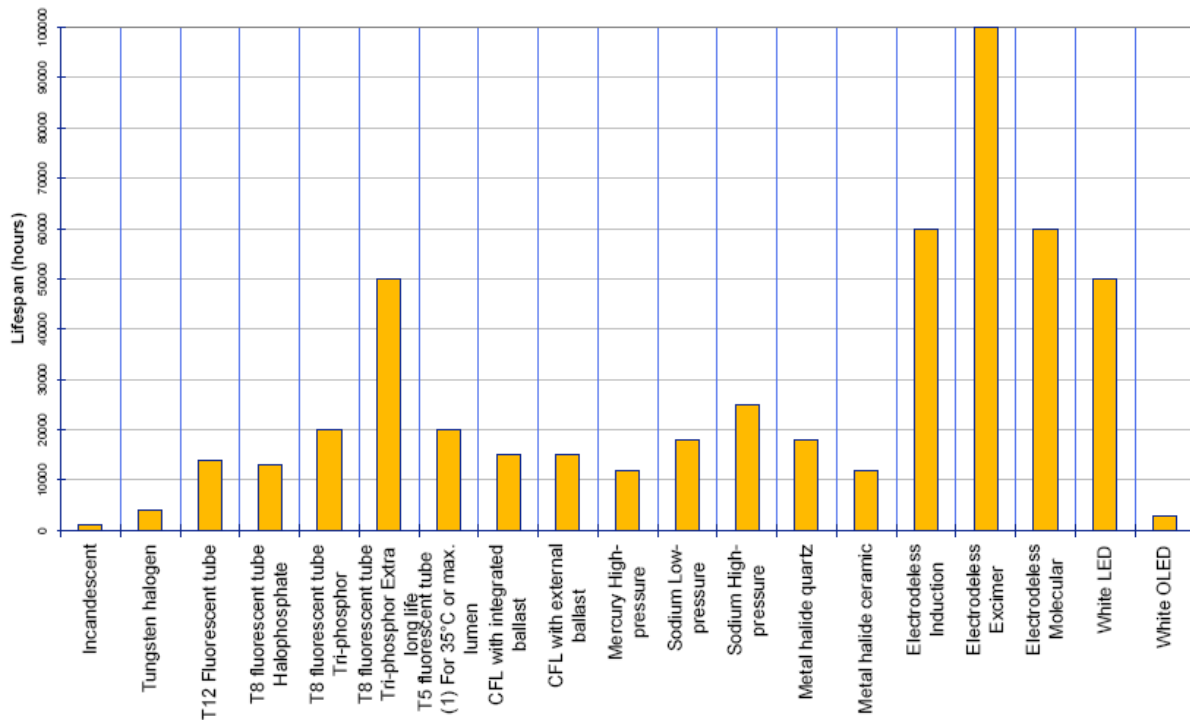

Figure 31: Typical lifespan of lamp technology (source: Laborelec)

In Figure 30 typical luminous efficacy ranges are included per lamp technology and in Figure 31 typical lamp life span.

In this section products are selected that are able to fulfil the product definition of chapter 1 and as a consequence the new standard (EN 12464).

This means that products such as incandescent or halogen lamps are excluded for further analysis in this study because the 500 lux 'maintained' illuminance requirement for office lighting would require more than 90 Watt per m²(900 lamp lumen needed if UF=0.75 & LMFxLLMF =0.7). It should be clear that this would transform an office into a furnace and that incandescent (typical 10 lumen/W) and halogen lamps (typical 20 lumen/W) should be excluded from this study because their application is unrealistic for the defined product purpose. Moreover halogen lamps (2000 h) and incandescent (1000 h) have relative low life spans and would create high maintenance costs in offices.

CFLni-lamps have lifetimes up to 15000h (in comparison with 20000h for T5) and are more expensive. They are also available in different, smaller sizes with a lower light output range (e.g. 550 lumen). These smaller lamps are therefore more used in area with lower lighting requirements such as corridors. The CFLni-lamps with 2G11 socket are mainly used where design or available space play a part. In chapter 8 these products will be qualitatively reconsidered in their proper application perspective but they are excluded for the Base case assessment.

T12 lamps are only sold in lower quantities (see chapter 2). T12 lamps have a lower efficacy compared to T8 lamps (see figure 4.1) but they perform particular well in cold environments and have a lower tube luminance that allows operation without luminaire optics. Therefore they still find application in outdoor industrial environment and it is unrealistic to assume that they are applied in office lighting. In chapter 8 these products will be qualitatively reconsidered in their proper application perspective but they are excluded for the Base case assessment in this chapter.

T8 fluorescent lamps are sold in Tri-phosphor and halophosphate, more info on the technology will be included in chapter 6. T8 halophosphate is more sold in numbers compared to Tri-phosphor (see chapter 2 (ELC data 2005)). T8 halophosphate lamps have poor colour rendering ($R_a < 80$) and therefore do not match the EN 12464-1 requirements for office work. In general, standard EN 12464-1 states that 'Lamps with a colour rendering index lower than 80 should not be used in interiors where people work or stay for longer periods'. Halophosphate lamps are therefore not commonly used when dimensioning new office lighting installations, however this does not exclude from use or at lamp replacement (see data chapter 2). Another important difference between halo- and tri-phosphate lamps is the poor efficiency of halophosphate lamps in comparison with the high efficiency of the tri-bands lamp. In chapter 6 and 8 the halo-phosphate lamps will be qualitatively reconsidered in their proper application perspective but they are excluded for the Base case assessment in chapter 5.

Table 62 includes the performance parameters for the selected lamp types that are used further in this study.

LLMF and LSF data for selected lamp types are retrieved from guideline CIE 97 (2005), η_{lamp} data was retrieved from the manufacturers catalogue.

The $\eta_{\text{lamp@50Hz}}$ data are for use with magnetic ballast and $\eta_{\text{lamp@HF}}$ data are for use with electronic ballasts (HF lamp current supply).

Table 62: Selected lamp efficacy and cost data

lamp type	ILCOS code	unit price (€)	Colour temp. (K) Ra	Plamp-50Hz	$\eta_{\text{lamp 50Hz}}$ (lm/W) (25 °C)	Plamp HF	$\eta_{\text{lamp HF}}$ (lm/W) (25°C)	LG F	$\eta_{\text{lamp HF}}$ (lm/W) (35°C)
LFL T8-36W Tri-phosphor	FD-36-E-G13-26/1200	2.1	4000 $80 \leq Ra \leq 89$	36	93	32	100	1	NA
LFL T8-18W Tri-phosphor	FD-18-E-G13-26/600	2.1	4000 $80 \leq Ra \leq 89$	NA	75	NA	82	1	NA
LFL T5-28W HE	FDH-28-G5-L/P-1150	3	4000 $80 \leq Ra \leq 89$	NA	NA	NA	93	1,12	104
LFL T5-14W HE	FDH-14-G5-L/P-550	3	4000 $80 \leq Ra \leq 89$	NA	NA	NA	86	1,13	96
LFL T5-54W HO	FDH-54-G5-L/P-1150	3.6	4000 $80 \leq Ra \leq 89$	NA	NA	NA	82	1,13	93
LFL T8-36W halophosphate	FD-36/41/2B-E-G13	1.1	4000 $Ra \approx 63$	36	79	NA	NA	1	NA
LFL T12-40W halophosphate	FD-40/41/2B-E-G13	1.6	4000 $Ra \approx 63$	NA	71	NA	NA	1	NA
LFL T5-54W HO constant	FDH-54-G5-L/P-1150		3000 $80 \leq Ra \leq 89$	NA	NA	NA	89	1,03	93
LFL T8-36W Tri-phosphor	FD-36/38/1A-E-G13	2.6	4000 $90 \leq Ra$	NA	78	NA	NA	1	NA
CFLni-36W	FSD-36/35/1B-E-2G11	3.4	3500 $80 \leq Ra \leq 89$	NA	80	NA	90	1	NA
CFLni-13W	FSQ-13/40/1B-E-G14q	3.4	4000 $80 \leq Ra \leq 89$	NA	NA	NA	72	1	NA

The LLMF and LSF values for the selected lamps are mentioned in Table 41 in section 3.2.2.

4.3.1.4 Assessment of relevant ballast types and product performance parameters

Table 63: Ballast losses according to CELMA class label

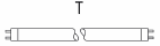
Lamp type	Ilcos code	Lamp power		CLASS						
				A1	A2	A3	B1	B2	C	D
	FD-15-E-G13-26/450	15W	13.5W	9W	16W	18W	21W	23W	25W	> 25W
	FD-18-E-G13-26/600	18W	16W	10,5W	19W	21W	24W	26W	28W	> 28W
	FD-30-E-G13-26/900	30W	24W	16,5W	31W	33W	36W	38W	40W	> 40W
	FD-36-E-G13-26/1200	36W	32W	19W	36W	38W	41W	43W	45W	> 45W
	FD-38-E-G13-26/1047	38W	32W	20W	38W	40W	43W	45W	47W	> 47W
	FD-58-E-G13-26/1500	58W	50W	29,5W	55W	59W	64W	67W	70W	> 70W
	FD-70-E-G13-26/1800	70W	60W	36W	68W	72W	77W	80W	83W	> 83W

EU 2000/55/EC Category 1

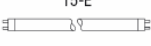
Lamp type	Ilcos code	Lamp power	CLASS						
			A1	A2	A3	B1	B2	C	D
	FDH-14-G5-L/P-16/550	14W	9,5W	17W	19W				
	FDH-21-G5-L/P-16/850	21W	13W	24W	26W				
	FDH-24-G5-L/P-16/550	24W	14W	26W	28W				
	FDH-28-G5-L/P-16/1150	28W	17W	32W	34W				
	FDH-35-G5-L/P-16/1450	35W	21W	39W	42W				
	FDH-39-G5-L/P-16/850	39W	23W	43W	46W				
	FDH-49-G5-L/P-16/1450	49W	29W	55W	58W				
	FDH-54-G5-L/P-16/1150	54W	31,5W	60W	63W				
	FDH-80-G5-L/P-16/1150	80W	47,5W	88W	92W				

Maximum ballast losses related to the EEI index are included in table 4.2. From this table the ballast efficiency can be calculated. For magnetic ballasts BLF = 0.95 is taken into account (see definition in chapter 1). When the ballast is for two or more lamps, the same efficiency as for the single lamp ballast was assumed. This is not always the case and ballasts with improved efficiency are on the market, this will be assessed in chapter 6. For luminaire production OEM ballast prices are used. OEM ballast prices are included after consulting luminaire manufacturers, the electronic ballast prices for replacement are discounted wholesales catalogue prices (-40 %). For magnetic ballast we assumed no failures in this study, hence no replacement prices were included hereafter.

Table 64: Performance and cost data for magnetic ballasts with capacitor and starter

lamp	ILCOS	EEI class	η ballast	OEM ballast price	starter price	capacitor (μ F)	capacitor price
LFL T8-36W	FD-36-E-G13-26/1200	C	0,76	NA	0,19	4,5	0,8
LFL T8-36W	FD-36-E-G13-26/1200	B2	0,8	1,45	0,19	4,5	0,8
LFL T8-36W	FD-36-E-G13-26/1200	B1	0,84	2,00	0,19	4,5	0,8
LFL T8-18W	FD-18-E-G13-26/600	B2	0,66	1,45	0,19	4,5	0,8
LFL T8-18W	FD-36-E-G13-26/1200	B1	0,71	2,00	0,19	4,5	0,8

Table 65: Performance and cost data for electronic ballasts

lamp	ILCOS	EEI class	η ballast	OEM ballast price	ballast price replacement	Pci (W)
2xLFL T8-36W	FD-36-E-G13-26/1200	A2	0,89	6,9	22	0
3xLFL T8-18W	FD-18-E-G13-26/600	A2	0,76	6,9	29	0
2xLFL T5-28W	FDH-28-G5-L/P-1150	A2	0,87	6,9	29	0
2xLFL T5-28W	FDH-28-G5-L/P-1150	A3	0,82	6,9	29	0
3xLFL T5-14W	FDH-14-G5-L/P-550	A2	0,82	7,9	30	0
1xLFL T5-54WHO	FDH-54-G5-L/P-1150	A2	0,9	7,9	29	0
1xLFL T5-54WHO	FDH-54-G5-L/P-1150	A3	0,86	7,9	29	0
2xLFL T8-36W	FD-36-E-G13-26/1200	A1	0,84	21	39	1
1xLFL T5-28W	FDH-28-G5-L/P-1150	A1	0,82	21	39	1
2xLFL T8-36W	FD-36-E-G13-26/1200	A3	0,84	6	20	0

4.3.1.5 Assessment of relevant luminaire types and performance parameters

LMF data for both luminaire types is retrieved from guideline CIE 97 (2005), see also § 3.2.2. In chapter 6, luminaires with improved LMF will be assessed.

UF will be calculated⁶¹ with different methods:

UF (flux code) can be calculated according to standard EN 13032-2 based on the CEN(CIE) flux code.

⁶¹ Data sourcing and calculation with support from <http://www.groenlichtvlaanderen.be>

The CEN (or CIE) flux code is representing the optical characteristics of the luminaire and consists of 9 whole numbers (see Figure 32) separated by spaces defined as:

FCL1/FCL4, FCL2/FCL4, FCL3/FCL4, DFF, LOR, FCU1/FCU4, FCU2/FCU4, FCU3/FCU4, UFF

equal to respectively,

N1, N2, N3, N4, N5, N6, N7, N8, N9.

Where,

UFF is upward flux fraction (= ULOR/LOR= 1-DFF)

DFF is downward flux fraction (=DLOR/LOR)

LOR is light output ratio

FCL1-4 are accumulated luminous fluxes in lower hemisphere for the four zones from 0° to 41.4° (FCL1), 60° (FCL2), 75.5° (FCL3) and 90° (FCL4).

FCU1-4 are accumulated luminous fluxes in upper hemisphere for the four zones from 180° to 138.6° (FCU1), 120° (FCU2), 104.5° (FCU3) and 90° (FCU4).

Remarks:

- For luminaires with downward flux only the CEN flux code in abbreviated form consists of only the first 5 whole numbers (N1, N2, N3, N4, N5):
- Please note that LOR is for lamps at optimum working temperature.

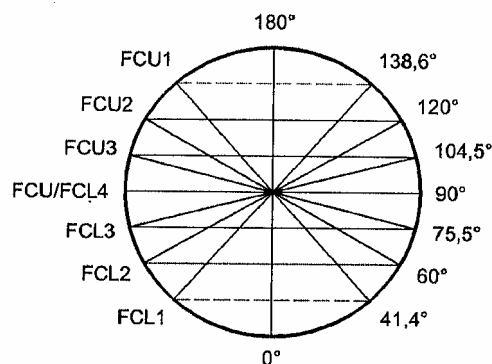

Figure 32: Downward and upward zones for the calculation of accumulated luminous fluxes

The calculation method from standard EN 13032-2 takes into account the typical room surface reflection (data see section 3.4.1) and room index (data see § 3.4.1).

UF (software) can be calculated with professional light planning&calculation software (see chapter 1)

UF = Average illuminance in task area (lux) x task area (m²)/(number of luminaires x total lamp lumen).

Note: During the UFsoftware calculation discrepancies among different software's were maximum 3%.

UFb is using a simplified approach to calculate UF based on product alone, based on the 3 numbers from the flux code, this approach is used in the Belgian implementation of the building directive (EPB Besluit (2005), EPB Bijlage 2 (2005)):

$$UFb = ((FCL3/FCL4)+0.5xUFF) \times LOR$$

In this approach for UFb it is assumed that only 50 % of the upward light output and all the light output within 60 ° is recovered on the task area (see Figure 32).

UFu is using a simplified approach to calculate UF based on product alone, based on the 3 numbers from the flux code, This approach is used as approximation for the UF in the UK Building Regulations Part L2 ((BNCL (2006)):

$$UFu = (DFF+0.5UFF)xLOR$$

In this approach for UFu it is assumed that only 50 % of the upward light and all the downward light output is recovered on the task area. This approach is related to validate the usefulness of the defined LERc in chapter 1.

The UF, UFsoftware, UFb and UFu values are assessed (Table 66, Table 67, Table 68, Table 69) for category A1 and A2 luminaires in both cellular and open plan office as defined in chapter 3 (typical values). The values obtained are from catalogue data. The luminaire prices are wholesale prices and include lamp and ballast. For commercial reasons no brand names are included. The 'extra' luminaire included in Table 66 is a bare batten (strip) luminaire, this luminaire is excluded from the Base case assessment in chapter 5 because it does not satisfy the EN 12464-1 requirements.

FCU1/FCU4, FCU2/FCU4, FCU3/FCU4 ratios from the flux code are not always given by the manufacturer, for the purpose of evaluation it can be assumed that the indirect light is mainly in the FCU1 and the following values will be therefore used as default values: FCU1/FCU4=0.75, FCU2/FCU4=1, FCU3/FCU4=1.

Table 66: UF, performance and cost data for category A1 (direct lighting) in a cellular office

luminaire ID number	A1.1	A1.2	A1.3	A1.4	A1.5	A1.6	A1.7	A1.8
Plamp (W)	18	18	36	36	14	14	54	54
Nla(lamps per lum.)	3	3	2	2	3	3	1	1
T5/T8 LFL	T8	T8	T8	T8	T5	T5	T5	T5
EEI ballast	B2	B2	B2	B2	A2	A2	A2	A3
LGF	1	1	1	1	1.13	1.13	1.13	1.13
Luminaire type	refractor	refractor	reflector	refractor	reflector	reflector	reflector	reflector
CIE flux code N1(41,4°)	0,57	0,49	0,76	0,47	0,64	0,73	0,79	0,65
CIE flux code N2(60°)	0,87	0,8	0,99	0,79	0,94	1	0,99	0,94
CIE flux code N3(75,5°)	0,96	0,95	0,99	0,96	0,99	1	0,99	0,99
CIE flux code N4(DFE)	1	1	1	1	1	0,99	1	1
CIE flux code N5(LOR)	0,63	0,49	0,66	0,47	0,67	0,73	0,72	0,66
UF flux code	0,441	0,320	0,534	0,302	0,499	0,575	0,594	0,494
UFsoftware	0,453	0,326	0,576	0,313	0,503	0,579	0,626	0,492
UFb	0,548	0,392	0,653	0,371	0,630	0,723	0,713	0,620
UFu	0,63	0,49	0,66	0,47	0,67	0,73	0,72	0,66
UFr	0,45	0,33	0,58	0,31	0,45	0,51	0,55	0,44
LER	31	24	49	35	47	51	53	49
LERc	31	24	49	35	47	51	53	49
Luminaire unit cost	110	166	77	96	97	97	129	78

luminaire ID number	A1.9	A1.10	A1.11	A1.12	A1.13	A1.14	A1.15	A1.16	Extra
Plamp (W)	28	28	28	28	28	28	28	28	36
Nla(lamps per lum.)	2	2	2	2	2	2	2	2	2
T5/T8 LFL	T5	T5	T5	T5	T5	T5	T5	T5	T8
EEI ballast	A2	A2	A3	A2	A2	A2	A2	A3	B2
LGF	1.12	1.12	1.12	1.12	1.12	1.12	1.12	1.12	1
Luminaire type	reflector	reflector	reflector	reflector	reflector	reflector	reflector	reflector	bare batten
CIE flux code N1(41,4°)	0,6	0,7	0,65	0,78	0,45	0,74	0,69	0,71	NA
CIE flux code N2(60°)	0,89	0,99	0,94	0,99	0,78	0,99	0,95	0,99	NA
CIE flux code N3(75,5°)	0,97	0,99	0,99	0,99	0,95	1	0,99	0,99	NA
CIE flux code N4(DFE)	1	1	1	1	1	0,99	1	1	0.48
CIE flux code N5(LOR)	0,685	0,83	0,69	0,83	0,55	0,76	0,59	0,85	0.9
UF flux code	0,492	0,647	0,517	0,680	0,347	0,602	0,455	0,667	0.45
UFsoftware	0,516	0,722	0,532	0,760	0,355	0,688	0,476	0,746	NA
UFb	0,610	0,822	0,649	0,822	0,429	0,745	0,561	0,842	NA
UFu	0,685	0,83	0,69	0,83	0,55	0,76	0,59	0,85	NA
UFr	0,46	0,64	0,47	0,68	0,32	0,61	0,42	0,67	0.66
LER	55	67	53	67	45	61	48	65	67
LERc	55	67	53	67	45	61	48	65	50
Luminaire unit cost	134	146	110	215	130	130	255	119	20

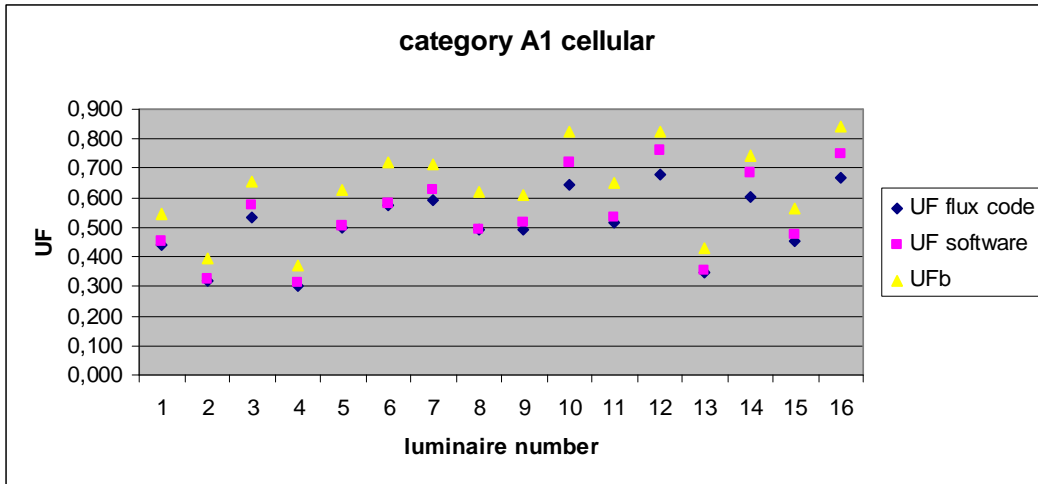

Figure 33: UF luminaire data for category A1 (direct lighting) in a cellular office.

Table 67: UF, for category A1 (direct lighting) in an open plan office (the same luminaires as in cellular office).

luminaire ID number	A1.1	A1.2	A1.3	A1.4	A1.5	A1.6	A1.7	A1.8
UF flux code	0,614	0,465	0,682	0,446	0,674	0,746	0,748	0,665
UFsoftware	0,670	0,454	0,701	0,293	0,685	0,770	0,773	0,664
UFr	0,670	0,454	0,701	0,293	0,606	0,681	0,684	0,588
UFb	0,548	0,392	0,653	0,371	0,630	0,723	0,713	0,620
UFu	0,63	0,49	0,66	0,47	0,67	0,73	0,72	0,66

luminaire ID number	A1.9	A1.10	A1.11	A1.12	A1.13	A1.14	A1.15	A1.16
UF flux code	0,676	0,848	0,696	0,860	0,517	0,777	0,600	0,870
UFsoftware	0,672	0,846	0,698	0,864	0,511	0,786	0,593	0,875
UFr	0,600	0,755	0,623	0,771	0,457	0,702	0,530	0,781
UFb	0,610	0,822	0,649	0,822	0,429	0,745	0,561	0,842
UFu	0,685	0,83	0,69	0,83	0,55	0,76	0,59	0,85

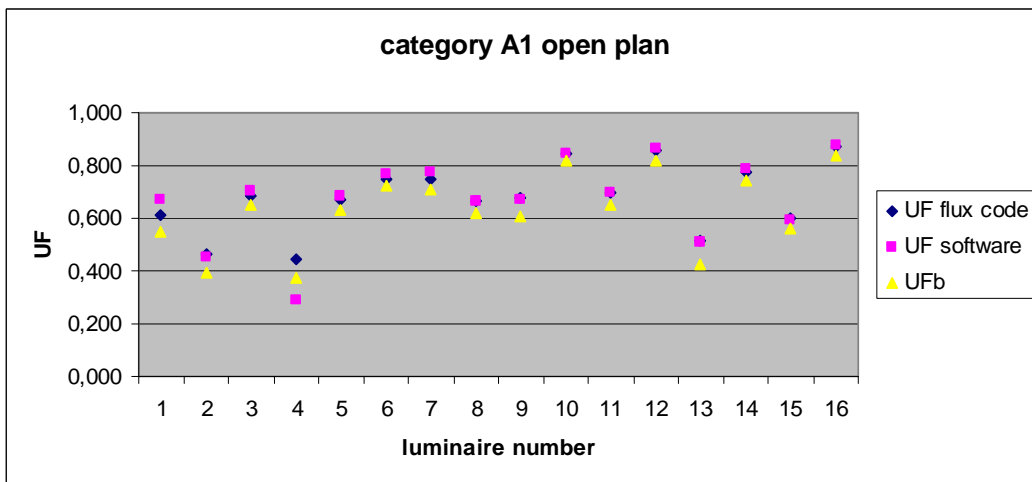

Figure 34: UF luminaire data for category A1 (direct lighting) in an open plan office

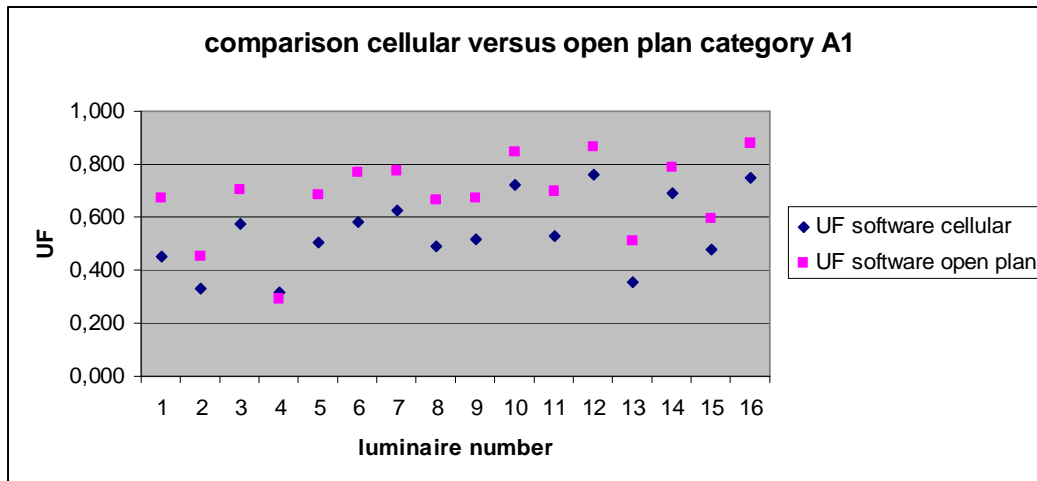

Figure 35 Comparison of UF values for cellular versus open plan office in category A1 luminaires.

Table 68: UF luminaire performance and cost data for category A2 (direct/indirect lighting) in a cellular office

luminaire ID number	A2.1	A2.2	A2.3	A2.4	A2.5	A2.6	A2.7	A2.8	A2.9	A2.10	A2.11
Plamp (W)	54	28	54	28	54	28	54	28	54	54	28
Nla(lamps per lum.)	2,00	2,00	1,00	2,00	1,00	2,00	1,00	2,00	2,00	1,00	2,00
T5/T8 LFL	T5	T5	T5	T5	T5	T5	T5	T5	T5	T5	T5
EEI ballast	A2	A2	A3	A2	A2	A2	A2	A2	A3	A1	A1
LGF	1.13	1.12	1.13	1.12	1.13	1.12	1.13	1.12	1.13	1.13	1.12
Luminaire type	Reflecto _r	Reflecto _r	Prisma + Reflecto _r	Prisma	Prisma	Reflecto _r	Reflecto _r	Prisma + Reflecto _r	Prisma + Reflecto _r	Reflecto _r	Reflecto _r
CIE flux code N1(41,4°)	0,74	0,75	0,50	0,65	0,63	0,70	0,74	0,72	0,41	0,74	0,74
CIE flux code N2(60°)	0,98	0,99	0,79	0,89	0,89	0,98	0,98	0,96	0,87	0,99	0,98
CIE flux code N3(75,5°)	0,99	0,99	0,93	0,97	0,97	0,99	0,99	0,99	0,97	0,99	0,99
CIE flux code N4(DFE)	0,35	0,92	0,19	0,12	0,11	0,38	0,85	0,36	0,17	0,49	0,53
CIE flux code N5(LOR)	0,91	0,74	0,81	0,83	0,78	0,95	0,91	0,90	0,83	0,83	0,85
CIE flux code N6(-41,4°)	0,75	0,75	0,75	0,75	0,75	0,75	0,75	0,75	0,75	0,75	0,75
CIE flux code N7(-60°)	1,00	1,00	1,00	1,00	1,00	1,00	1,00	1,00	1,00	1,00	1,00
CIE flux code N8(-75,5°)	1,00	1,00	1,00	1,00	1,00	1,00	1,00	1,00	1,00	1,00	1,00
CIE flux code N9(UFF)	0,53	0,63	0,39	0,39	0,36	0,56	0,53	0,52	0,83	0,51	0,47
UF flux code	0,58	0,60	0,40	0,39	0,35	0,58	0,54	0,55	0,39	0,54	0,57
UFsoftware	0,61	0,70	0,45	0,45	0,42	0,65	0,61	0,60	0,43	0,56	0,60
UFb	0,61	0,71	0,48	0,46	0,43	0,66	0,61	0,61	0,47	0,61	0,64
UFu	0,53	0,63	0,39	0,39	0,36	0,56	0,53	0,52	0,49	0,62	0,65
UFR	0,52	0,54	0,36	0,35	0,31	0,52	0,48	0,49	0,39	0,50	0,53
LER	67	60	57	67	58	77	67	73	59	59	65
LERc	45	57	34	38	32	53	62	50	34	44	50
Luminaire unit cost	250	250	250	250	250	250	250	250	250	250	250

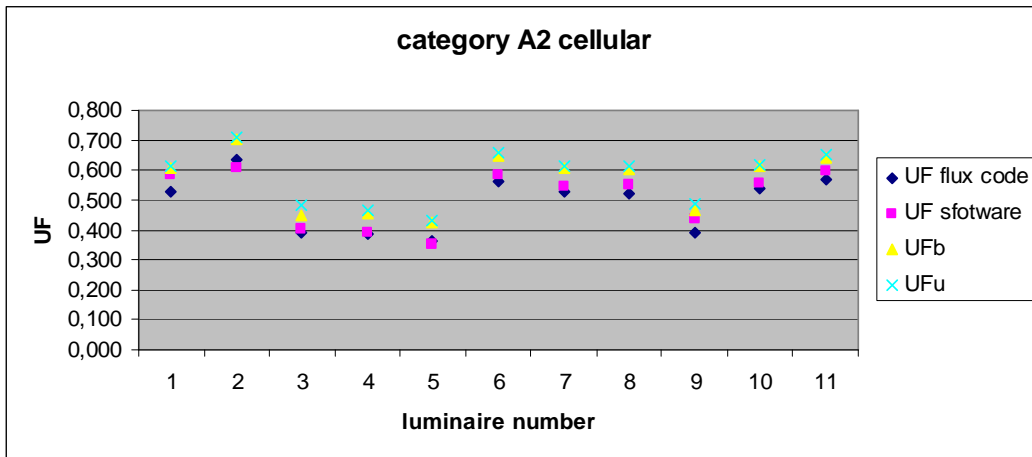

Figure 36 UF luminaire data for category A2 (direct/indirect lighting) in a cellular office

Table 69: UF luminaire performance and cost data for category A2 (direct/indirect lighting) in an open plan office

luminaire ID number	A2. 1	A2. 2	A2. 3	A2. 4	A2. 5	A2. 6	A2. 7	A2. 8	A2. 9	A2. 10	A2. 11
UF flux code	0,669	0,683	0,535	0,544	0,509	0,703	0,815	0,661	0,544	0,648	0,674
UFsoftware	0,748	0,761	0,581	0,579	0,535	0,772	0,733	0,732	0,604	0,723	0,756
UFR	0,668	0,680	0,519	0,517	0,477	0,690	0,654	0,654	0,539	0,646	0,675
UFb	0,608	0,704	0,450	0,454	0,423	0,648	0,826	0,599	0,467	0,614	0,641
UFu	0,614	0,710	0,482	0,465	0,433	0,656	0,842	0,612	0,486	0,618	0,650

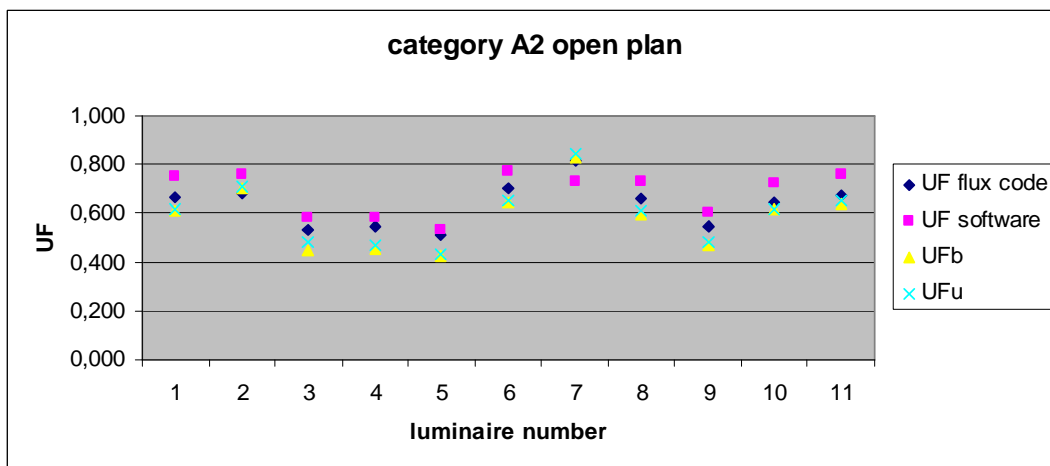

Figure 37 UF luminaires data for category A2 (direct/indirect lighting) in a cellular office

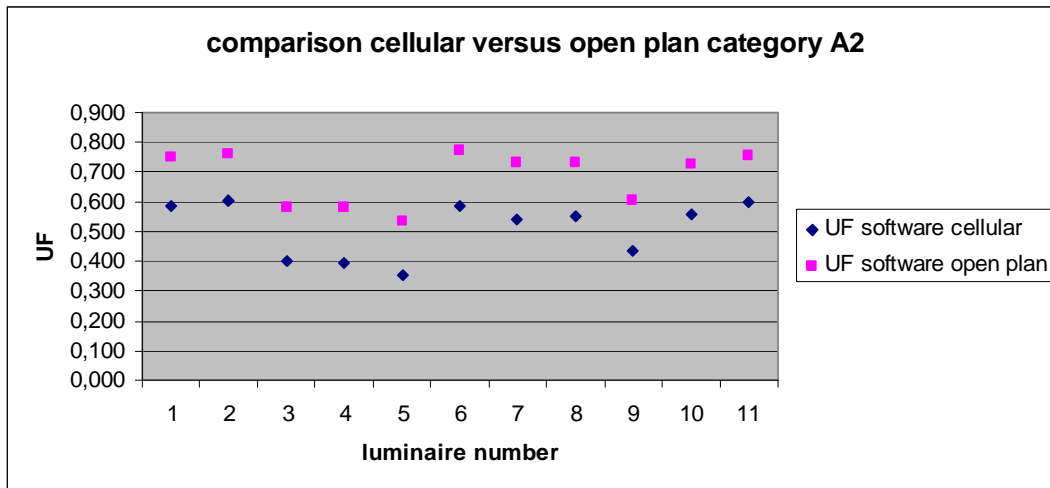

Figure 38 Comparison UF values cellular versus open plan office for category A2 luminaires

Conclusions:

- There is a very good agreement between the UF flux code and UF software.
- There is a very good agreement between UF flux code and UFb in an open plan office.
- There is a good correlation between UF flux code and UFb in a cellular office but for category A1 luminaires UFb is systematic higher compared to UF flux code. This is due to the high influence of surface reflection in a cellular offices, much more compared to open plan offices.
- There is a very good agreement between UF flux code and UFb in a cellular office for category A2 luminaires.
- UFb or UFu can be calculated independent of the office room properties and can be easily calculated from the related CIE (CEN) flux code.
- There is a large spread in UF software values found for products on the market, a summary is enclosed hereafter. For further calculations UFr will be used in order to allow comparison between T5 and T8 LFL lamps (as explained in chapter 1). Table 70 data will be used in further chapters.

Table 70: Minimum , maximum, average and median UFr

	cellular office				open plan office			
	UFRmin	UFRavg	UFRmed	UFRmax	UFRmin	UFRavg	UFRmed	UFRmax
cat. A1 luminaires	0,31	0,49	0,49	0,68	0,29	0,62	0,53	0,78
cat. A2 luminaires	0,31	0,45	0,42	0,54	0,48	0,61	0,58	0,69

UFRavg is the calculated average UFr value from the assessed luminaires.

UFRmed is the median UFr value i.e. the average between the minimum and maximum found.

Remark:

UF values for cellular offices were systematic lower compared to open plan offices.

4.3.2 Assessment of resources consumption (energy, lamps) during product life in off-standard conditions (i.e. at variable load)

The relevant parameters for the characterisation of off-standard are defined in chapter 3 and are: BMF (Ballast Maintenance Factor) and BGF (Ballast Gain Factor). They take into account, a.o. the effect of dimming and presence detection. The quantitative assessment of these parameters (BMF, BGF) was also done in chapter 3 and only the applicable formulas are enclosed hereafter.

The real power consumption (P_{real}) per luminaire is related to the standard power consumption by:

$$P_{\text{real}} [\text{W}] = P / (\text{BMF} \times \text{BGF})$$

The real annual energy consumption (E_{yreal}) per luminaire is related to the standard energy consumption by:

$$E_{\text{y}} [\text{kWh}] = E_{\text{y}} [\text{kWh}] / (\text{BMF} \times \text{BGF})$$

4.4 Use phase (system)

This task is important to understand the limitations that are imposed by the office building environment and also aspects related to 'putting into service of office lighting equipment'. This paragraph identifies and describes the functional system to which the product in question belongs and identifies and quantifies to the extent possible those product features that can reduce the environmental impact not only of the product but of the system as a whole. Please note that the scope of the system analysis is wider than the scope of the EuP Directive. The question that should be posed during the analysis is whether and how the system performance could be improved leading to environmental benefits with measures that are restricted only to issues that can be influenced by technical features or additional information of the product under investigation as defined in chapter 1. Furthermore, the system analysis serves as an addition to the more traditional product-specific analysis in paragraph 4.3, i.e. to design product specific legislation (if any) in such a way that it would not make system-oriented innovations impossible.

General description of the product system interference for office lighting

The light reflectance on the indoor surfaces can create a large system interference on the task area illumination, e.g. by indirect light from reflection on the ceiling. This surface reflectance interference will be further discussed in this chapter.

Daylight entrance in the building can also contribute much to energy savings (see also chapter 3) and is system or building related. Building management systems connected to luminaires for switching or controlling illumination can also contribute to energy savings and are system related, energy saving is possible by building management systems when they take daylight

and occupancy into account. In this study this is taken into account at product level when a building management interface is present or not in a luminaire. Please note that daylight and occupancy related energy savings are estimated and discussed in chapter 3. At system level there is a relationship with the Energy Performance of Buildings (EPB) directive (2002/91/EC) that will be further discussed.

Impact assessment of the surface reflectance on the UF parameter

Hereafter the influence of the office room surface reflection characteristics on UFsoftware is assessed by simulation software according to reflection data for 'very bright', 'typical' and 'very dark offices' (values see chapter 3).

Table 71: Office reflection values used in this study

	very bright	typical (default)	very dark
Reflectance ceiling	0.9	0.7	0.5
Reflectance wall	0.8	0.5	0.3
Reflectance floor cavity	0.4	0.2	0.2

Therefore UF values from section 4.3.1.5 are recalculated by software simulation.

Table 72: UF luminaire performance for category A1 (direct lighting) in a cellular office for room with very dark, typical and bright surface reflectance.

luminaire ID number	A1.9	A1.10	A1.11	A1.12	A1.13	A1.14	A1.15	A1.16
UFsoftware (typical)	0,516	0,722	0,532	0,760	0,355	0,688	0,476	0,746
UFsoftware (very dark)	0,468	0,679	0,483	0,720	0,306	0,647	0,441	0,699
UFsoftware (very bright)	0,747	0,973	0,759	0,993	0,556	0,907	0,666	0,994

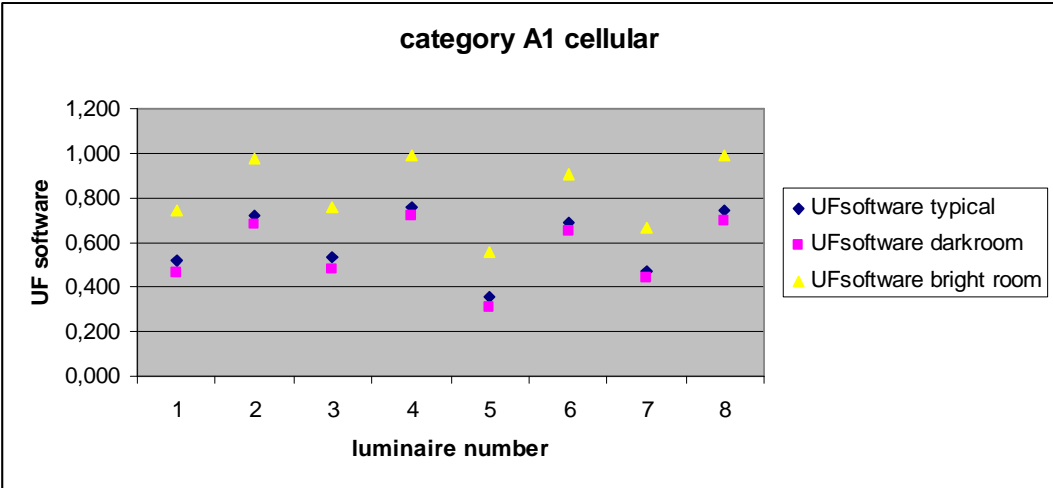

Figure 39 UF luminaire performance for category A1 (direct lighting) in a cellular office for room with very dark, typical and bright surface reflectance.

Table 73: UF luminaire performance for category A1 (direct lighting) in an open plan office for room with very dark, typical and bright surface reflectance.

luminaire ID number	A1. 9	A1. 10	A1. 11	A1. 12	A1. 13	A1. 14	A1. 15	A1. 16
UFsoftware (typical)	0,67	0,85	0,70	0,86	0,51	0,79	0,59	0,87
UFsoftware (very dark)	0,63	0,81	0,66	0,82	0,45	0,74	0,56	0,82
UFsoftware (very bright)	0,917	1,137	0,935	1,142	0,713	1,04	0,802	1,16

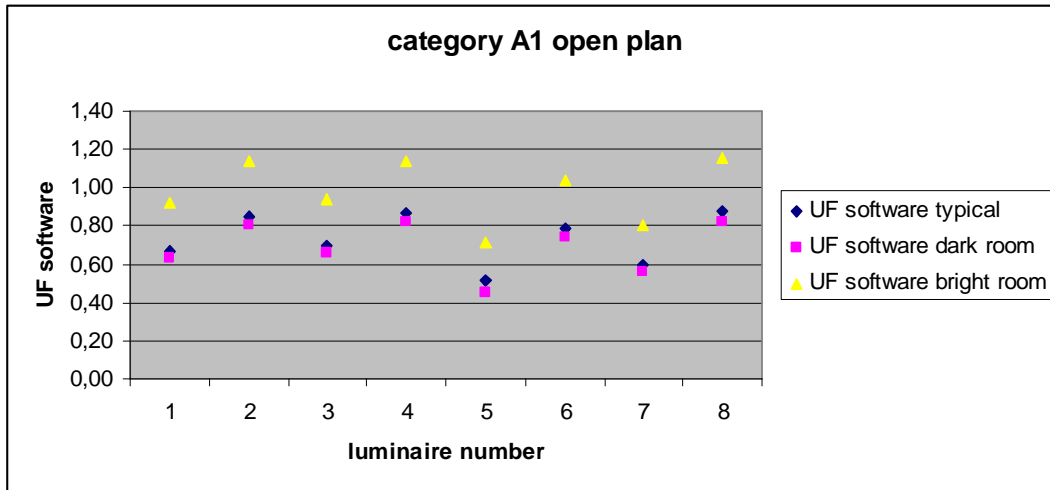

Figure 40 UF luminaire performance for category A1 (direct lighting) in an open plan office for room with very dark, typical and bright surface reflectance.

Table 74: UF, UFsoftware, UFb and UFu luminaire performance and cost data for category A2 (direct/indirect lighting) in a cellular office

luminaire ID number	A2.1	A2.2	A2.3	A2.4	A2.5	A2.6	A2.7	A2.8	A2.9	A2. 10	A2. 11
UFsoftware (typical)	0,584	0,605	0,402	0,394	0,351	0,585	0,542	0,550	0,435	0,556	0,596
UFsoftware (very dark)	0,462	0,548	0,276	0,260	0,228	0,462	0,419	0,430	0,301	0,457	0,500
UFsoftware (very bright)	0,976	0,867	0,789	0,797	0,729	0,994	0,946	0,946	0,832	0,904	0,942

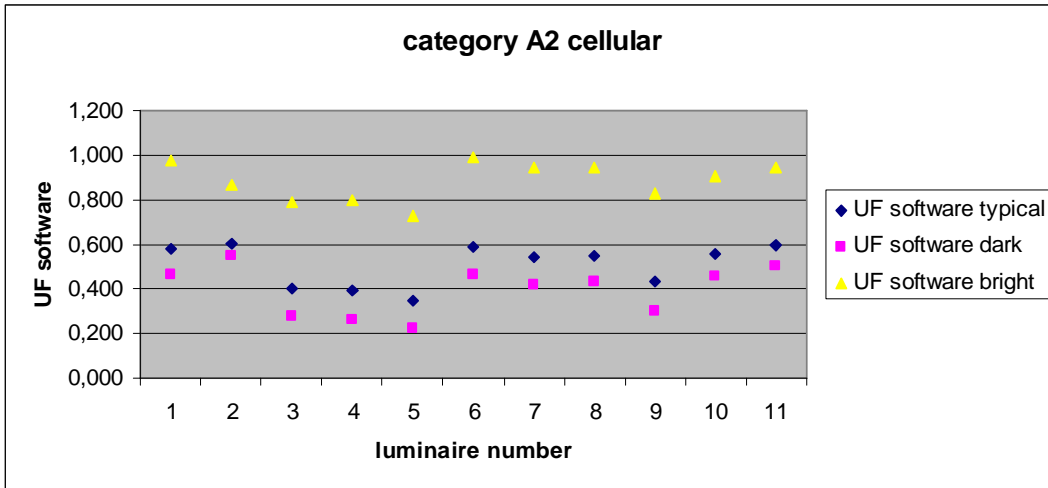

Figure 41 UF luminaire performance for category A2 (direct/indirect lighting) in a cellular office for room with very dark, typical and bright surface reflectance.

Table 75: UF, UFsoftware, UFb and UFu luminaire performance and cost data for category A2 (direct/indirect lighting) in a open plan office

luminaire ID number	A2.1	A2.2	A2.3	A2.4	A2.5	A2.6	A2.7	A2.8	A2.9	A2.10	A2.11
UFsoftware (typical)	0,748	0,761	0,581	0,579	0,535	0,772	0,733	0,732	0,604	0,723	0,756
UFsoftware (very dark)	0,594	0,736	0,420	0,405	0,370	0,618	0,578	0,581	0,434	0,603	0,639
UFsoftware (very bright)	1,198	1,061	1,017	1,034	0,965	1,235	1,186	1,182	1,053	1,113	1,148

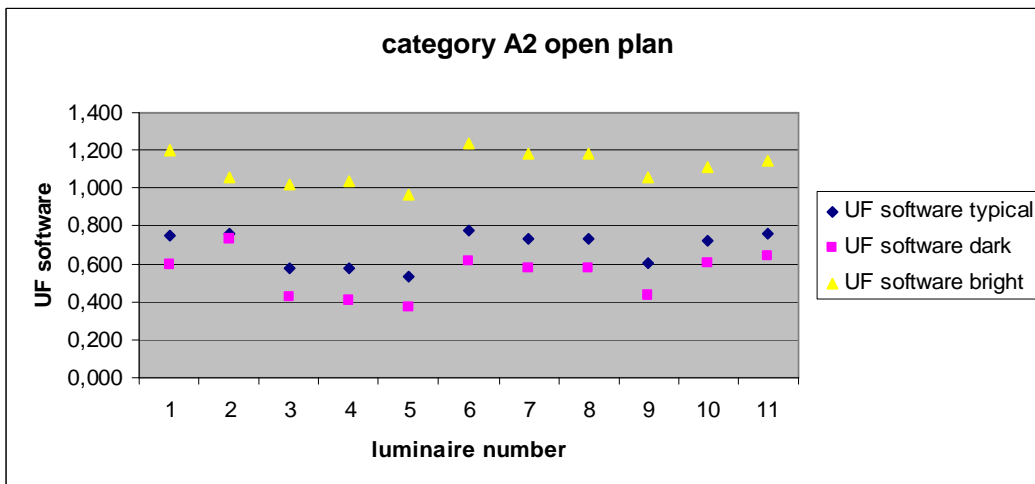

Figure 42 UF luminaire performance for category A2 (direct/indirect lighting) in an open plan office for room with very dark, typical and bright surface reflectance.

Conclusions:

- The difference between the defined typical and very dark office is relatively low.

- There is a significant increase in UF for very bright offices (estimated about 35 %). This means that high savings could be realised if offices have bright surfaces (ceilings, walls, floors, desks).
- Luminaires with high UF remain relatively high compared to luminaires with low UF independent of the room reflectance. There is no change in ranking observed.

Relationship with the Energy Performance of Buildings (EPB) directive (2002/91/EC)

The Directive on energy efficiency of buildings was adopted on 16th December 2002 and entered into force on 4th January 2003. It is considered as a very important legislative component of energy efficiency activities of the European Union designed to meet the Kyoto commitment and responds to issues raised in the recent debate on the Green Paper on energy supply security.

The Directive is set to promote the improvement of energy performance of buildings with four requirements to be implemented by the Member States :

- General framework for a methodology of calculation of the integrated performance of buildings
- Setting of minimum standards in new and existing buildings
- Energy Certification of Buildings
- Inspection and assessment of heating and cooling installations.

The Directive is foremost a measure that concerns a very large number of actors on all levels and with different impacts and different motivations: designer, housing associations, architects, providers of building appliances, installation companies, building experts, owners, tenants, essentially all energy consumers in the European Union.

In order to provide a standard calculation method in the framework of the EPB directive standard prEN 15193 on 'Energy performance of buildings - Energy requirements for lighting' is under preparation.

This draft European Standard is submitted to CEN members for formal vote. It has been drawn up by the Technical Committee CEN/TC 169 "Light and lighting", the secretariat of which is held by DIN. This European Standard was devised to establish conventions and procedures for the estimation of energy requirements of lighting in buildings, and to give a methodology for a numeric indicator of energy performance of buildings. It also provides guidance on the establishment of notional limits for lighting energy derived from reference schemes. Having the correct lighting standard in buildings is of paramount importance and the convention and procedures assume that the designed and installed lighting scheme conforms to good lighting practices. For new installations the design will be to EN 12464-1. This European Standard also gives advice on techniques for separate metering of the energy used for lighting that will give regular feedback on the effectiveness of the lighting controls. The methodology of energy estimation not only provides values for the numeric indicator but will also provide input for the heating and cooling load impacts on the combined total energy performance of building indicator. The methodology and format of the presentation results would satisfy the requirements of the EC. This European Standard specifies the calculation methodology for the evaluation of the amount of energy used for indoor lighting inside the building and provides a numeric indicator for lighting energy requirements used for certification purposes. This European Standard can be used for existing buildings and for the design of new or renovated buildings. It also provides reference schemes to base the targets for energy allocated for

lighting usage. This European Standard also provides a methodology for the calculation of instantaneous lighting energy use for the estimation of the total energy performance of the building. Parasitic powers not included in the luminaire are excluded. In this European Standard, the buildings are classified in the following categories: offices, education buildings, hospitals, hotels, restaurants, sports facilities, wholesale and retail services and manufacturing factories.

The main parameter is the 'Lighting Energy Numeric Indicator' (LENI) [kWh/(m² × year)] defined as: numeric indicator of the total annual lighting energy required in the building.

The LENI can be used to make direct comparisons of the lighting energy used in buildings that have similar functions but are of different size and configuration.

Please note that it is a calculation standard and that no limits are set (e.g. on W/m², surface reflection, ..).

4.5 End-of-life phase

The environmental impact of the end-of-life phase is modelled according to the VHK-model. The parameters used as input for this environmental assessment are shown in the following table and are identical for all types of lamps, control gear and luminaires. Most input data in the end of life phase are directly related to the input parameters for the production. An important factor that must be defined here is the percentage of mercury content that is not captured during the processing of the waste lamps. At this moment we assume that 10% of the mercury present in lamps is emitted during the end of life processing. We have not found any public information on this average percentage of fugitive mercury in EU-25. We assume that public data will get available in the near future due to the WEEE requirements.

Table 76: Input data for the environmental assessment of the end of life processing of the lamps, gear and luminaires

DISPOSAL & RECYCLING		unit
Description		
<u>Substances released during Product Life and Landfill</u>		
Refrigerant in the product (Click & select)	0	g
Percentage of fugitive & dumped refrigerant	0%	
Mercury (Hg) in the product	0 to 0.005	g Hg
Percentage of fugitive & dumped mercury	10%	
<u>Disposal: Environmental Costs per kg final product</u>		
Landfill (fraction products not recovered) in g en %		5%
Incineration (plastics & PWB not re-used/recycled)		g
Plastics: Re-use & Recycling ("cost"-side)		g
<u>Re-use, Recycling Benefit</u>	in g	% of plastics fraction
Plastics: Re-use, Closed Loop Recycling (please edit%)		1%
Plastics: Materials Recycling (please edit% only)		9%
Plastics: Thermal Recycling (please edit% only)		90%
Electronics: PWB Easy to Disassemble ? (Click&select)		NO
Metals & TV Glass & Misc. (95% Recycling)		

The parameters that are taken into account for the modelling of the environmental impact of the lamps, gear and luminaires are assumed to be identical. According to the VHK default values it is assumed that 5% of the materials go to landfill, 90% of the plastics is incinerated, 9% is recycled and 95% of the metals and glass is recycled.

5 DEFINITION OF THE BASE CASE

This chapter is on Task 5 of the lot 8 EuP preparatory study on Office Lighting. The task 5 comprises of an assessment of average EU product(s), the so called “base cases”.

A base case product is “a conscious abstraction of reality” and is the “representative for an entire product group” (in terms of BOM, characteristics, performance, costs and environmental impact). The description of the base case(s) is the synthesis of the results of Tasks 1 to 4. Most of the environmental and life cycle cost analysis are built on these base cases throughout the rest of the study and it serves as the point-of-reference for Task 6 (technical analysis of BAT), Task 7 (improvement potential), and Task 8 (impact analysis).

According to the MEEUP methodology, the scope of a preparatory study should be covered by one or two base cases in Task 5. In chapter 1, a functional classification in direct lighting (A1) and direct+indirect lighting (A2) is introduced. Also, luminaires for open plan offices and cellular offices are distinguished in both categories A1 and A2. Due to varying characteristics among these classes, 4 Base cases are selected to represent this diversity of end-applications and to represent the existing market segments in a comprehensive manner. Detailed analysis of a large number of base cases will also allow us a more realistic assessment of improvement potentials in the subsequent tasks and EU 25 total environmental impact.

In this study the 4 base cases are selections within each segment of real products that exist on the market since 1990, are still sold today and of which the performance meets the minimum requirements set by EN 12464-1:

- Base case Category A1, cellular office: luminaire with two 36 W T8 LFL lamps, having a aluminium reflector and two electromagnetic ballasts operating the two lamps (A1.3 in table 14).
- Base case Category A1, open plan office: luminaire with the same characteristics as for A1, but with different UF value (A1.3 in table 15).
- Base case Category A2, cellular office: luminaire with one 54 W T5 LFL lamp, having a refractor and one electronic ballast (A2.3 in table 16).
- Base case Category A2, open office: luminaire with the same characteristics as for A2 cellular office, but with different UF value (A2.3 in table 17).

Note that in this study 4 real existing products are selected as most representative for the 4 base cases and are not 4 weighted average (non-existing) base cases constructed on the basis of all products assessed within each segment (cfr. chapter 4). This is done to make the study more comprehensive for the reader.

The assessment of environmental impacts and life cycle costs (LCC) is hence based on these 4 base cases.

After the analysis of the abovementioned base cases, the results are aggregated in order to arrive at the total impacts of the Lot 8 products.

The base cases are assessed with the EcoReport tool of MEEUP methodology (Tool for EcoReport Calculations, version 5). The input data and results are thus presented in the EcoReport format and are available for consultation at our project website www.eup4light.net. Main inputs to the analysis come from Task 2 and 4. Task 4 provides input data for the base cases, namely, Bill of Materials (BOM), packaging and packaged volume, energy consumption during the use phase and considerations regarding the end-of-life of materials.

Total EU25 sales and stock figures, as well as data on product prices, energy rates and interest-inflation rates were established in Task 2. These will serve to assess the Life Cycle Cost. Because no market data are available on number of office luminaires installed or annual sales, these are derived from total office surface in the EU25 (installed base), and office surface growth and replacement of end-of-life office lighting (sales).

On the basis of Task 1, 3, and 4 it can be deduced that the product differentiation between Standard and Real-Life base cases, as proposed in the MEEuP, is only marginal. There are generally few reasons in this study to discriminate standard from real life product operation conditions, the only difference between standard and real life in this study is $BMF = 0.95$ for ferromagnetic ballasts (see chapter 3). In the Base case calculations hereafter, this BMF is therefore always taken into account and no further differentiation is made between “standard-” or “real-life Base case”.

As mentioned before, it is assumed that the “standard base case” product is installed according to EN 12464-1 (2004), setting a performance requirement of 500 lux for office task areas (see chapter 1) and a colour rendering requirement of $Ra > 80$. Before the standard EN 12464-1(2004) was introduced most countries set lower illuminance requirements (see chapter 2). Also, it is not sure in how far this standard of 500 lx is currently implemented for new installations. This aspect is of importance in chapter 8 for the scenario analysis where the density of new installed luminaires (n°/km^2 office) is calculated to meet this 500 lx standard since 2005 (and 400 lx on average for EU25 in period 1990-2004).

For the purpose of this base case calculation in chapter 5, triphosphor fluorescent will be selected as the type of reference lamp, because only this fluorescent lamp satisfies the current colour rendering requirements of EN 12464-1 ($Ra > 80$). In reality however, the lower efficient halophosphate lamps can still be used for new installations and are often also used to replace triphosphor lamps in existing installations. The latter has however no influence on the energy consumption but only provides less and lower quality light from the luminaire. This study however does assess the potential positive impact of substituting halophosphate with triphosphor luminaires (and banning replacement of triphosphor with halophosphate lamps). In chapter 7, halophosphate is discussed in the ‘worst case’ option 1, and in chapter 8 a scenario 1990-2020 with halophosphate lamp use versus base case triphosphor lamp use is compared to demonstrate this.

The base case calculation does not take into account a real-life based mix in the stock of ballasts with different efficiency classes (EEI). In the base cases, a ballast of EEI-class B2 is assumed for the 2 base case direct lighting luminaires and EEI-class A2 for the 2 base case direct+indirect lighting luminaires. To compensate for this real-life versus default base case assumption, and also to take into account the effects of Directive 2000/55/EC where the use of EEI-class D and class C ballast are phased out in new installations since 2002 and 2005

accordingly, a correction factor has been developed and applied in the scenario analysis in chapter 8 (see section 8.1.2).

The Task 5 document is structured as follows:

- Section 5.1: specific inputs for the environmental impact assessment
- Section 5.2: environmental impact assessment
- Section 5.3: the life cycle costs
- Section 5.4: the EU Totals

5.1 Product-specific inputs

Base case environmental impacts assessment (EIA) and life cycle cost calculation is carried out for products manufactured and sold in 2005. The reference year for the EU totals is 2005 as for environmental impacts. 'EU' is synonymous to 'EU-25'.

- **BOM**

The Bill of Materials for the various Base case product configurations (luminaire including lamp and ballast) can be consulted in tables 2 to 5 from chapter 4.

See "LFL T8-36 W" (for Base cases A1) and "LFL T5-54 W" (for Base cases A2) in table 2 for BOM of lamps. A mercury content of 5 mg is assumed for these LFL lamps. These inputs are multiplied with the amount of lamps used over the lifetime of the luminaire (see parameter "Ny" in table below).

See "Magnetic ballast for LFL T8-36 W, EEI=B2" in table 3 for BOM of electromagnetic ballast (for Base cases A1) and "Electronic ballast for 1xLFL T5-54 W (EEI=A2)" in table 4 for BOM of electronic ballast (for Base case A2). These inputs are multiplied with the amount of ballasts used over the lifetime of the luminaire (see parameter "Ballast use" in table below).

See "Ceiling mounted luminaire 2xLFL T8-36W (closed top housing reflector) built-up" (for Base cases A1) and "Suspended luminaire 1xLFL T5-54W (direct/indirect)" (for Base cases A2) in table 5.

- **Manufacturing**

For average primary scrap production during sheet metal manufacturing, the default value of 25% proposed in the EcoReport for primary scrap is assumed for all the products.

- **Distribution**

The average volume of the packaged product was taken, as defined in Task 4 (section 4.2). The weight of the (packaged) product is clearly below the threshold of 15 kg of the EcoReport tool (section 4.2.1). Thus, the question "Is it an ICT or Consumer Electronics product <15 kg?" is answered 'YES'..

- **Use Phase**

As explained in section 4.3, the energy consumption of the product configuration is the sum of the energy use for its operation and parasitic or stand by energy losses

(parameter “Pci” in the table below). Pci is zero except for dimmable ballasts, but these are not assumed as the Base case.

The two Base cases of A1 have the same energy consumption per unit of product, but have different 'functional' lumen outputs (see definition chapter 1), hence can provide light at 500 lx for a different task area (m²) (see parameter “A (at 500 lx)” in table below). For this reason, the Base case results are also shown per 1000 lm functional light output. This is also true for the two Base cases of A2. See section 4.3.1.1 to 4.3.1.5 for technical analysis of input data which were necessary for the calculation of use phase electricity consumption and functional lumen output. In the following table, an overview of the settings for the Base cases are provided.

Table 77: input parameters base cases (technical, costs)

AVG. INPUT PARAMETERS		Base Case luminaire A1 (Cellular Office)	Base Case luminaire A1 (Open Office)	BaseCase luminaire A2 (Cellular Office)	BaseCase luminaire A2 (Open Office)
Lamp type		LFL T8 Tri-phosphor	LFL T8 Tri-phosphor	LFL T5 Tri-phosphor	LFL T5 Tri-phosphor
Lamps per luminaire		2	2	1	1
Ballast type		Magnetic (EEI=B2)	Magnetic (EEI=B2)	Electronic (EEI=A2)	Electronic (EEI=A2)
Ballasts per luminaire		2	2	1	1
Plamp	W	36	36	54	54
Pci	W	0,00	0,00	0,00	0,00
Lamp lumen (25°C)	lm	3348	3348	4428	4428
Mercury content lamp	mg	5,00	5,00	5,00	5,00
Lamp replacement time	y	6,00	6,00	8,00	8,00
Ē _m (illumination maint.)	lx	500,00	500,00	500,00	500,00
η _{lamp} (25°C)	lm/W	93,00	93,00	82,00	82,00
LLMF		0,90	0,90	0,90	0,90
LSF		0,50	0,50	0,50	0,50
η _{ballast}		0,80	0,80	0,90	0,90
Ballast failure rate	% per 1000h	0,0%	0,0%	0,2%	0,2%
Lamp unit cost	€	2,29	2,29	3,60	3,60
Ballast unit cost, replacement	€	2,90	2,90	29,00	29,00
UFsoftware (=UFr x LGF)		0,49	0,53	0,47	0,65
LMF		0,80	0,80	0,84	0,84
RSMF		0,96	0,96	0,93	0,93
Luminaire unit cost	€	77,00	77,00	250,00	250,00
Luminaire life time	y	20	20	20	20
Burning hours	h/y	2500	2500	2500	2500
LGF (35°C/25°C)		1	1	1,12	1,12
BGF		1	1	1	1
BMF		0,95	0,95	1	1

Table 78: output parameters base cases (technical, costs)

AVG. OUTPUT PARAMETERS		Base luminaire (Cellular Office)	case A1	Base luminaire (Open Office)	case A1	Base luminaire (Cellular Office)	case A2	Base luminaire (Open Office)	case A2
Ny (annual lamp cons.)	n°/yr	0,50		0,50		0,19		0,19	
Ballast use	n°	2,00		2,00		1,10		1,10	
FU (functional lumen)	lm_f	2.274		2.453		1.474		2.032	
P	W	90		90		60		60	
Ey (burning hrs)	kWh/y	237		237		150		150	
Ey (parasitic)	kWh/y	0		0		0		0	
Ey	kWh/y	237		237		150		150	
Ey/FU	$kWh/(y.lumen)$	0,10		0,10		0,10		0,07	
PP, Purchase Price	€	87,61		87,61		260,61		260,61	
OE, lamp replacement/y	€/y	1,15		1,15		0,68		0,68	
OE, ballast replacement	€/y	0,00		0,00		0,15		0,15	
OE, electricity	€/y	21,32		21,32		13,50		13,50	
OE, maintenance/y	€/y	1,55		1,55		1,26		1,26	
LCC	€	487,86		487,86		520,35		520,35	
LCC/FU ((€/lumen)		0,21		0,20		0,35		0,26	
A (at 500 lx)	$m^2 office$	4,5		4,9		2,9		4,1	
LPD	$W/(m^2.100lx)$	4,17		3,86		4,07		2,95	
Hg(yr)	mg	2,5		2,5		0,9		0,9	

The EcoReport tool calculates a fixed 1% of components as spare parts. As this is taken in to account with lamp replacement and ballast failure rate, the resulting impacts of this EcoReport parameter will not be taken into account for the interpretation of the results.

Product life is evaluated in task 3 and is set to 20 years average luminaire life. Ballast and lamp life are calculated by means of several input parameters of which an overview in the Table 77 above.

- **Disposal and Recycling**

For disposal and recycling the default entries of the EcoReport tool are assumed (see table 22). The percentage of fugitive & dumped mercury is set lower at 10% than the default in the VHK Ecoreport (20%) due to RoHS, WEEE implementation and the existence of take back and recycling schemes for LFL lamps.

- **Life cycle costs**

Inputs for Life Cycle Costs (LCC) are derived from previous tasks, in particular task 2. The base case LCC are assessed for products manufactured and sold in 2005. In Table 77, an overview is given of the product-specific cost data on the used lamps, ballasts (including capacitor and ignitor) and luminaire (see also section 4.3). In section 2.4 the LCC related parameter on electricity rate, interest and inflation, maintenance costs are evaluated. The cost parameters that are assumed the same for all 4 defined Base cases, are also presented in the following Table 79:

Table 79: non-product specific input parameters LCC

functional luminaire life	y	20
labour cost	€/h	31,83
t-luminaire install	h	0,33
t-lamp install group	h	0,05
t-lamp install spot	h	0,33
t-luminaire cleaning	h	0,03
period maintenance (fixture cleaning)	y	2
interest rate	%	3,90 %
inflation rate	%	2,10 %
discount rate	%	1,80 %
PWF	y	16,7
kWh price	€/kW h	0,09

o **EU totals**

- The following assumption is made in order to calculate the total number of installed luminaires in the EU25 and for calculating the EU25 total impacts and costs (see Table 80).:

Table 80: input parameters for EU25 totals, 2005

Cellular Offices	%	48%
Open plan (landscape) Offices	%	52%
A1 direct lighting	%	73%
A2 direct+indirect lighting	%	27%
EU25 total office space	km ²	1.139
Trend office space increase before/after 2005	%	2%
Annual increase offices	km ²	22,78
Share of total office area used as task area	%	60%
Average \bar{E}_m (stock)	lx	400
Average \bar{E}_m (new)	lx	500

The amount of luminaires are determined from the share of office surface, representative for a Base case category, divided by the surface lit by one Base case luminaire, e.g.:

- o $48\% \times 73\% \times 1139 \text{ km}^2$ and this divided by the surface one Base case luminaire (A1, cellular) can lit at 400 lx (average \bar{E}_m for installed base) is the total installed base of Base case A1 luminaires for cellular offices.
- o $48\% \times 73\% \times (22,78 \text{ km}^2 + 1/20 \text{ years} \times 1139 \text{ km}^2)$ and this divided by the surface one Base case luminaire (A1, cellular) can lit at 500 lx (required \bar{E}_m

for new installations) is the total sales of Base case A1 luminaires for cellular offices. Sales includes new luminaires for new offices and replacement of end-of-life luminaires.

5.2 Base case Environmental Impact Assessment

The following Table 81 shows the results of the environmental impact assessment of 'A1' and 'A2' Base cases. As mentioned before, this is at 'product unit' level the same for open plan and cellular offices, but differs per 1000 lm output, this is shown in Table 82. The use phase impacts are calculated with an average product lifetime of 20 years. In all tables, the MEEUP impact indicators 1 (use of Bulk Plastics), 15 (Ozone Depleting Substances) and 23 (POP's) are not shown since these impacts are not applicable or negligible.

Table 81: Life Cycle Impact (per unit) of Base case Luminaire A1, A2 and aggregated

Base case >			Base case luminaire A1			Base case luminaire A2			AGGREGATED (weighted average based on 73% A1 and 27% A2)		
Resources Use and Emissions											
	Materials	unit	(PRO D)	(RECY CL.)	(RECY CL.)	(PRO D)	(RECY CL.)	(RECY CL.)	(PRO D)	(RECY CL.)	(RECY CL.)
2	TecPlastics	g	22	2	(10%)	12	1	(10%)	19	2	(10%)
3	Ferro	g	5808	5517	(95%)	5307	5042	(95%)	5639	5357	(95%)
4	Non-ferro	g	1360	1292	(95%)	1251	1188	(95%)	1323	1257	(95%)
5	Coating	g	28	27	(95%)	11	10	(95%)	22	21	(95%)
6	Electronics	g	18	9	(50%)	10	5	(50%)	15	8	(50%)
7	Misc.	g	1330	1264	(95%)	499	474	(95%)	1049	997	(95%)
	Total weight	g	8566	8111	(95%)	7089	6720	(95%)	8067	7641	(95%)
	Other Resources & Waste		(non-USE)	(USE)	(TOTAL)	(non-USE)	(USE)	(TOTAL)	(non-USE)	(USE)	(TOTAL)
8	Total Energy (GER)	MJ	891	49743	50634	823	31505	32328	868	42557	43425
9	of which, electricity (in primary MJ)	MJ	109	49738	49847	89	31501	31590	102	42553	42655
10	Water (process)	ltr	19	3316	3335	9	2100	2109	16	2837	2853
11	Water (cooling)	ltr	40	13263	13267	33	84000	84034	38	11347	11350
12	Waste, non-haz./landfill	g	19016	57851	76867	16517	36682	53199	18171	49508	67679
13	Waste, hazardous/incinerated	g	107	1147	1254	60	726	786	91	981	1072
Emissions (Air)											
14	Greenhouse Gases in GWP100	kg CO2 eq.	61	2171	2232	56	1375	1431	59	1857	1917
16	Acidification, emissions	g SO2 eq.	276	12809	13085	242	8113	8355	264	10959	11223
17	Volatile Organic Compounds (VOC)	g	4	19	23	4	12	16	4	16	20
18	Persistent Organic Pollutants (POP)	ng i-Teq	181	328	509	165	208	374	176	281	456
19	Heavy Metals	mg Ni eq.	95	854	949	84	541	625	91	731	822
	PAHs	mg Ni eq.	124	99	223	119	63	183	122	85	207
20	Particulate Matter (PM, dust)	g	146	274	420	136	174	309	143	234	377
Emissions (Water)											
21	Heavy Metals	mg Hg/20	85	322	407	73	204	276	81	275	356
22	Eutrophication	g PO4	1	2	2	1	1	2	1	1	2

For Base case A1, the total life cycle primary energy use is 50,6 GJ, of which 49,8 due to electricity. Electricity use is 237 kWh per year (see Table 77) per product, resulting in 4,74 MWh over the products entire lifetime.

For Base case A2, the total life cycle primary energy use is 32,3 GJ, of which 31,6 due to electricity. Electricity use is 150 kWh per year, resulting in 3 MWh over 20 years luminaire life.

Table 82: comparison of A1 and A2 Base cases per 1000 functional lumen output for open plan and cellular offices

	Other Resources & Waste		Base case luminaire A1 (Cellular Office)	Base case luminaire A1 (Open Office)	Base case luminaire A2 (Cellular Office)	Base case luminaire A2 (Open Office)
8	Total Energy (GER)	MJ	22327	20642	22094	15976
9	of which, electricity (in primary MJ)	MJ	21980	20321	21589	15611
10	Water (process)	ltr	1471	1360	1441	1042
11	Water (cooling)	ltr	58501	54086	57430	41527
12	Waste, non-haz./ landfill	g	33894	31336	36358	26289
13	Waste, hazardous/ incinerated	g	553	511	537	389
Emissions (Air)						
14	Greenhouse Gases in GWP100	kg CO2 eq.	984	910	978	707
16	Acidification, emissions	g SO2 eq.	5770	5334	5710	4129
17	Volatile Organic Compounds (VOC)	g	10	9	11	8
18	Persistent Organic Pollutants (POP)	ng i-Teq	224	207	255	185
19	Heavy Metals	mg Ni eq.	418	387	427	309
	PAHs	mg Ni eq.	98	91	125	90
20	Particulate Matter (PM, dust)	g	185	171	211	153
Emissions (Water)						
21	Heavy Metals	mg Hg/20	179	166	189	137
22	Eutrophication	g PO4	1	1	1	1

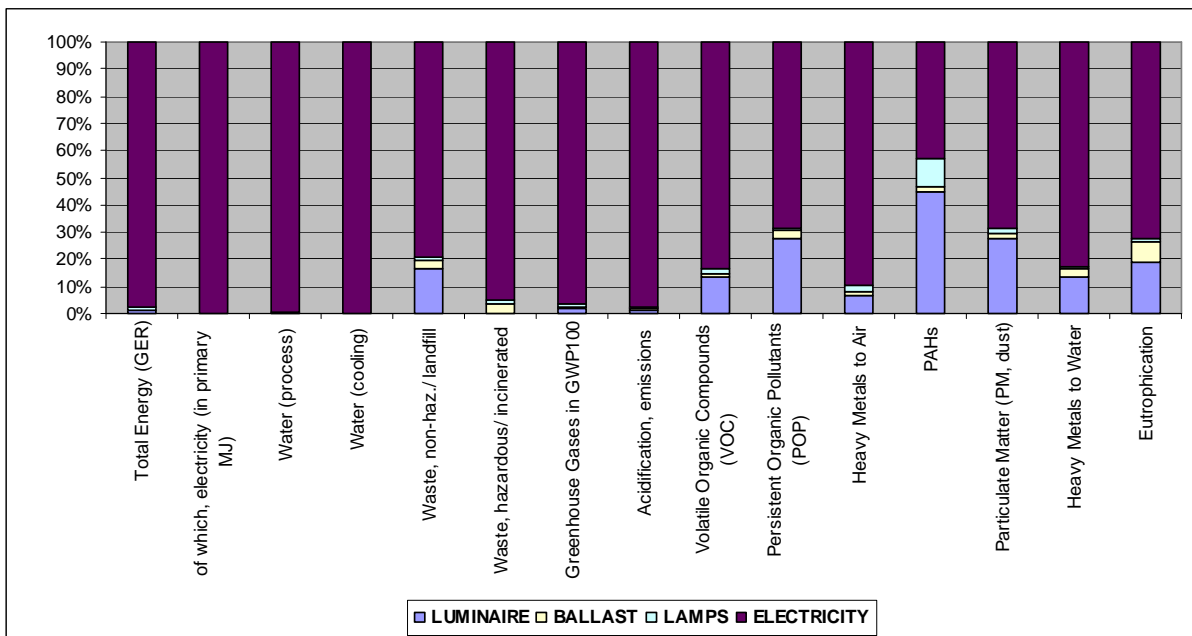

Figure 43: distribution of impacts over luminaire, ballast use, lamp use, electricity use A1 (similar for A2)

Table 83: distribution of impacts over life cycle phases A1 (similar for A2)

		PRODUCTIO N	DISTRI- BUTION	USE	END-OF- LIFE
	Other Resources & Waste				
8	Total Energy (GER)	1%	0%	99%	0%
9	of which, electricity (in primary MJ)	0%	0%	100%	0%
10	Water (process)	1%	0%	99%	0%
11	Water (cooling)	0%	0%	100%	0%
12	Waste, non-haz./ landfill	21%	0%	78%	1%
13	Waste, hazardous/ incinerated	5%	0%	93%	2%
	Emissions (Air)				
14	Greenhouse Gases in GWP100	1%	1%	98%	0%
16	Acidification, emissions	1%	0%	98%	0%
17	Volatile Organic Compounds (VOC)	4%	10%	86%	0%
18	Persistent Organic Pollutants (POP)	31%	0%	68%	1%
19	Heavy Metals	7%	1%	91%	1%
	PAHs	49%	2%	49%	0%
20	Particulate Matter (PM, dust)	9%	13%	69%	9%
	Emissions (Water)				
21	Heavy Metals	18%	0%	82%	0%
22	Eutrophication	25%	0%	69%	5%

As can be shown in the detailed Table 81, Table 83 and Figure 43, the electricity use is dominant for all impact categories.

Impacts where material-related impacts come to front are PAHs, non-hazardous waste, POPs, HM to air and water, PM dust and Eutrophication. These are briefly discussed as these impacts can be traced back in the VHK MEEUP methodology.

- The apparent contribution of the lamps to the emission of PAHs to air is due to 2 aspects, i) the contribution of the distribution phase of the lamps and ii) the number of lamps needed during the whole life span of the luminaire. The emission of PAHs to air for one lamp is insignificant (2% compared to the contribution of the luminaire), but considering the number of lamps needed during 20 years this contribution increases to 25% compared to the luminaire contribution. This emission is almost entirely caused during the distribution phase of the lamps due to a fixed energy and fuel consumption that is included in the VHK model for space heating and lighting, travels etc., that is independent of the size or weight of the product (and is here accounted for 10 lamps, 2 ballasts and one luminaire in base case A1; 3,75 lamps, 1,1 ballasts and one luminaire in base case A2).
- The contribution of the 2 magnetic ballasts to non-hazardous waste is for the largest part caused by the production of the copper wire (only for A1, not applicable in A2 electronic ballast) and to a minor extent by the production of the steel sheet for the core of the inductor and the housing. The production of the ignitor, modelled in the VHK model as a PWB, is responsible for the contribution to the hazardous waste. Both the copper wire and the ignitor (PWB) are also responsible for the emissions of heavy metals to water, that are released during the production of the materials. The emissions of POP to air are released during the production of the steel sheet for the core and housing of the ballast.

- The contribution of the luminaire to non-hazardous waste is entirely caused by the production of both materials used for the luminaire: steel sheet and aluminium sheet. The production of the steel sheet is also responsible for the emissions of POP (entirely) and heavy metals (partly) to air. The majority of the heavy metals emissions however are related to the recycling of the production scrap (released during manufacturing). The significant share of PAH emissions to air of the luminaire is due to the production of aluminium sheet. The high PAH factor for aluminium sheet is caused by the carbon anode during primary aluminium production from alumina. 50% of the PM emissions is released during the distribution of the luminaire, due to a fixed energy and fuel consumption that is included in the VHK model for space heating and lighting, travels etc. The remaining 50% of the PM emissions occur during the production of the steel and aluminium sheet and during the end-of-life phase (landfill of materials). The distribution of the luminaire, more specifically the transport to the warehouses, is responsible for nearly all emissions of VOC to air that occur during the material-related life cycle of the luminaire.

Table 6 shows the distribution of the impacts over the life cycle phases. Also this shows the dominance of the electricity use over the product lifetime. For non-electricity use related impacts, we should look more closely to impacts from production, distribution and end-of-life of the various product parts: lamps, ballast and luminaire.

- Looking at the contribution of the life cycle stages (excluding the use phase) of the *lamps*, the distribution phase dominates (>90%) the impact on total energy requirement (GER), greenhouse gas emissions to air, acidification emissions, VOC to air and emissions of heavy metals and PAHs. Nearly all the electricity and water consumption occurs during the production of the materials for the lamps. The majority of the waste is released during distribution (app. 70%) and far less during production (app. 20%). More than 50% of the emissions of PM to air and the eutrophication emissions to water are caused during the end-of-life treatment, followed by the distribution (30-40%). The contribution of the production phase on both impact categories is rather small (2-10%).

The dominant contribution of the distribution phase of the lamps is inherent to the VHK model, which assumes a fixed energy consumption for the heating/lighting of retail shops etc., independent of the size of the product. This causes small-sized products to potentially have a relatively high impact during the distribution phase.

- *Electromagnetic ballast for LFL T8-36W lamp*
The production of the materials required for the ballast dominates (>90%) the electricity and water consumption, waste production, emissions of persistent organic pollutants to air, heavy metals emissions to water and eutrophication. The production phase is also responsible for the majority of VOC- and heavy metals emissions to air and for acidification (app. 70%). The production and distribution phase contribute equally to the total energy requirement (GER) and emissions of greenhouse gasses and PAHs to air. 50% of the particulate matter is released during the end-of-life, the remaining PM emissions occur mostly during production (30-40%), to a lesser extent during distribution (<10%). A limited amount of electricity (2%) and water (6%) is recovered during recycling of metals and plastics.

- *Electronic ballast for 1xLFL T5-54W lamp*

The contribution of the respective life cycle phases of the electronic ballast differ only little with the electromagnetic ballast for the LFL T8-36W lamp.

The production of the materials contributes most (>90%) to the majority of the impact categories: electricity and water consumption, waste production, emissions of VOC, persistent organic pollutants and PAHs to air, emissions of heavy metals to water and eutrophication. The contribution of the production phase to acidification emissions is also significantly higher than the contribution of the other phases (70%). The production and distribution phase contribute equally to the total energy requirement (GER), emissions of greenhouse gasses and heavy metals to air (each 50%). 50% of the PM is released during production, 40% during end-of-life and the remainder during the distribution phase.

An important difference with the electromagnetic ballast is the high amount of electricity (80%) that is recovered during recycling (incineration) of ballast materials. The recovery of the PWB-assembly also has lower emissions of heavy metals to water (20-30%).

As was the case for the lamps, the impact of the distribution phase is caused by the assumption of a fixed energy consumption for the heating/lighting of retail shops etc., independent of the size of the product, in the VHK-methodology. The higher weight of the ballasts cause the relative impact of the distribution phase to be much less than that of the lamps.

- The production of the materials for the *luminaires* is responsible for more than 90% for the luminaire contribution to electricity and water consumption, waste production, emissions of persistent organic pollutants and PAHs to air and heavy metals to water. The contribution of the production phase is also significantly higher than the other phases (60-70%) for total energy requirements (GER), greenhouse gas and acidification emissions to air, heavy metals to air and eutrophication to water. The remaining contribution comes from the distribution phase, except for heavy metals to air (for which the remainder is equally caused by the distribution and end-of-life phase) and for eutrophication (the remaining 20% come from the end-of-life phase). The distribution phase contributes for more than 50% to the emissions of VOC and particulate matter to air, the remaining contribution is divided between the other phases.

5.3 Life Cycle Costs

Table 84: Life Cycle Costs (per unit) luminaire for reference year 2005

€	Base case or Option -->	Base case luminaire A1		Base case luminaire A2		AGGREGATED (weighted average based on 73% A1 and 27% A2)	
	Item						

D	Product price	77,00	16%	250,00	48%	135,31	27%
E	Installation/ acquisition costs (if any)	10,61	2%	10,61	2%	10,61	2%
F	Electricity	355,37	72%	225,06	43%	311,45	62%
H	Aux. 1: lamp replacement (PP)	19,09	4%	11,25	2%	16,45	3%
I	Aux. 2 :ballast replacement (PP)	-	0%	2,42	0%	0,81	0%
K	Repair & maintenance costs	29,78	6%	25,65	5%	28,38	6%
	<i>(K)</i> <i>(of which due to lamp replacement)</i>	<i>19,16</i>	<i>(64%)</i>	<i>14,37</i>	<i>(56%)</i>	<i>17,55</i>	<i>(62%)</i>
	Total	491,84		524,99		503,01	

For Base case A1, the total cost of the product that operates for 20 years is 492 €, of which 355 € is due to the electricity use, contributing 72% to total LCC. Initial purchase costs for luminaire acquisition and installation (row D and E) are 18%. Maintenance costs (row K), meaning labour cost for relamping and cleaning of the luminaire represent 6% and cost of goods for lamp replacement and ballast replacement represent an additional 4%. About 2/3 of these labour costs are due to relamping.

For Base case A2, LCC is 525 €, of which 225 € due to electricity use, contributing 43% to total LCC and which is clearly different from base case A1. This is due to the relatively high initial purchase price of the luminaire contributing 48% to the total LCC while in base case A1, purchase price only contributes 16%. Costs for labour (lamp replacement and luminaire cleaning, row K) are similar to that of base case 1. It is slightly less because base case A2 concerns a luminaire with only 1 lamp (compared to 2 lamps in A1 luminaire) and also, the lamp replacement interval is longer (8 years compared to 6 years).

5.4 EU Totals

The EU total environmental impacts of the stock of luminaires in 2005 (produced, in use, discarded) are listed in the following Table 85. Table 86 presents the annual consumer expenditure for the 2005 stock of luminaires.

The total annual primary energy of the stock in 2005 is 281 PJ of which 25,9 TWh is due to electricity use. This is equivalent to 6,7 Mtoe⁶² or 0,41% of the total EU25 primary energy use in 2005 (1637 Mtoe). Office lighting generates 519 kt non-hazardous (or landfilled) waste and 7,2 kt hazardous (or incinerated) waste; 12,5 MT CO₂-eq. greenhouse gas emissions; 73 kt SO₂-eq. acidifying gasses.

Heavy metals emitted to air are about 5,7 ton Ni-eq. and to water 2,7 ton Hg/20. The mercury contained in lamps that are annually disposed is about 5 ton. Since the percentage of fugitive & dumped mercury is set to 10%, this means 0,5 ton that is emitted (to air and water). This would mean that the share of heavy metals emitted from production and scrap recycling processes (see section 5.2) is more substantial than the emission of mercury from the lamps. Of course, this is also mainly to the high recovery rate of mercury from lamps at their end-of-life.

⁶² MT oil equivalents

For the production of office lighting, materials used are 63 kt of ferros and 15 kt non-ferros and make up 86% of the total materials use (90 kt). Also due to this high metal content, products have a high recycling rate of 95%.

Total annual costs for office lighting are in the range of 4,3 billion € for EU-25, thereof 2,3 billion € (or 55%) on electricity use; 1,5 billion € on product purchases; 0,2 billion on labour for maintenance and relamping and 0,125 billion on lamp purchases.

Table 85: EU Total Impact of STOCK of base case Luminaires in 2005 (produced, in use, discarded)

2005			Base case luminaire A1 (Cellular Office)			Base case luminaire A1 (Open Office)			Base Case luminaire A2 (Cellular Office)			Base Case luminaire A2 (Open Office)			TOTAL		
		unit	PRODUCTION	RECYCLING	RECYCLING / PRODUCTION	PRODUCTION	RECYCLING	RECYCLING / PRODUCTION	PRODUCTION	RECYCLING	RECYCLING / PRODUCTION	PRODUCTION	RECYCLING	RECYCLING / PRODUCTION	PRODUCTION	RECYCLING	RECYCLING / PRODUCTION
	Materials																
2	TecPlastics	kt	0,08	0,01	(10%)	0,08	0,01	(10%)	0,03	0,00	(10%)	0,02	0,00	(10%)	0,21	0,02	(10%)
3	Ferro	kt	21,46	20,39	(95%)	21,50	20,42	(95%)	11,24	10,68	(95%)	8,81	8,37	(95%)	63,01	59,86	(95%)
4	Non-ferro	kt	5,03	4,78	(95%)	5,04	4,78	(95%)	2,65	2,52	(95%)	2,08	1,97	(95%)	14,79	14,05	(95%)
5	Coating	kt	0,10	0,10	(95%)	0,10	0,10	(95%)	0,02	0,02	(95%)	0,02	0,02	(95%)	0,25	0,23	(95%)
6	Electronics	kt	0,07	0,03	(50%)	0,07	0,03	(50%)	0,02	0,01	(50%)	0,02	0,01	(50%)	0,17	0,08	(50%)
7	Misc.	kt	4,92	4,67	(95%)	4,92	4,68	(95%)	1,06	1,00	(95%)	0,83	0,79	(95%)	11,72	11,14	(95%)
	Total weight	kt	31,66	29,97	(95%)	31,71	30,02	(95%)	15,02	14,24	(95%)	11,76	11,15	(95%)	90,15	85,39	(95%)
	Other Resources & Waste		non-USE	USE	TOTAL	non-USE	USE	TOTAL	non-USE	USE	TOTAL	non-USE	USE	TOTAL	non-USE	USE	TOTAL
8	Total Energy (GER)	PJ	3,29	102,59	105,88	3,30	102,75	106,05	1,74	37,25	38,99	1,37	29,18	30,54	9,70	271,76	281,46
9	of which, electricity (in primary PJ)	PJ	0,40	102,58	102,98	0,40	102,74	103,14	0,19	37,24	37,43	0,15	29,17	29,32	1,14	271,73	272,88
10	Water (process)	mln. m3	0,07	6,84	6,91	0,07	6,85	6,92	0,02	2,48	2,50	0,01	1,94	1,96	0,18	18,12	18,29
11	Water (cooling)	mln. m3	0,15	273,54	273,69	0,15	273,97	274,12	0,07	99,31	99,38	0,06	7,79	77,85	0,42	724,61	725,03
12	Waste, non-haz./ landfill	kt	70,28	119,31	189,59	70,39	119,50	189,89	34,99	43,37	78,36	27,41	33,97	61,38	203,07	316,15	519,22
13	Waste, hazardous/ incinerated	kt	0,39	2,37	2,76	0,40	2,37	2,76	0,13	0,86	0,99	0,10	0,67	0,77	1,02	6,27	7,28
	Emissions (Air)																
14	Greenhouse Gases in GWP100	mt CO2 eq.	0,22	4,48	4,70	0,22	4,48	4,71	0,12	1,63	1,75	0,09	1,27	1,37	0,66	11,86	12,52
16	Acidification, emissions	kt SO2 eq.	1,02	26,42	27,44	1,02	26,46	27,48	0,51	9,59	10,10	0,40	7,51	7,91	2,95	69,98	72,93
17	Volatile Organic	kt	0,01	0,04	0,05	0,01	0,04	0,05	0,01	0,01	0,02	0,01	0,01	0,02	0,04	0,10	0,14

2005			Base case luminaire A1 (Cellular Office)			Base case luminaire A1 (Open Office)			Base Case luminaire A2 (Cellular Office)			Base Case luminaire A2 (Open Office)			TOTAL		
	Compounds (VOC)																
18	Persistent Organic Pollutants (POP)	g i-Teq	0,67	0,68	1,35	0,67	0,68	1,35	0,35	0,25	0,60	0,27	0,19	0,47	1,97	1,79	3,76
19	Heavy Metals	ton Ni eq.	0,35	1,76	2,11	0,35	1,76	2,11	0,18	0,64	0,82	0,14	0,50	0,64	1,02	4,67	5,68
	PAHs	ton Ni eq.	0,46	0,20	0,66	0,46	0,20	0,66	0,25	0,07	0,33	0,20	0,06	0,26	1,37	0,54	1,91
20	Particulate Matter (PM, dust)	kt	0,54	0,57	1,11	0,54	0,57	1,11	0,29	0,21	0,49	0,22	0,16	0,39	1,59	1,50	3,09
	Emissions (Water)																
21	Heavy Metals	Ton Hg/20	0,31	0,66	0,98	0,31	0,66	0,98	0,15	0,24	0,39	0,12	0,19	0,31	0,90	1,76	2,66
22	Eutrophication	kt PO4	0,00	0,00	0,01	0,00	0,00	0,01	0,00	0,00	0,00	0,00	0,00	0,00	0,01	0,01	0,02
	Mercury use	Ton Hg			2,11			2,12			0,45			0,36			5,04

Table 86: total annual expenditure in EU25

	Base case >	Base luminaire A1 (Cellular Office)	Case luminaire A1 (Open Office)	Base case luminaire A2 (Cellular Office)	Case luminaire A2 (Open Office)	TOTAL
	<i>(prices in mln.€)</i>					
D	Product price	283,81	284,96	525,81	413,07	1.507,65
E	Installation/ acquisition costs (if any)	39,11	39,27	22,32	17,53	118,22
F	Electricity	897,18	900,80	324,23	254,72	2.376,93
H	Aux. 1: lamp replacement (PP)	48,23	48,43	16,22	12,75	125,63
I	Aux. 2 :ballast replacement (PP)	-	-	3,49	2,74	6,22
K	Repair & maintenance costs	75,23	75,54	36,98	29,05	216,80
	Total	1.343,57	1.348,99	929,04	729,85	4.351,46

6 TECHNICAL ANALYSIS BAT AND BNAT

Scope: This entails a technical analysis and description of the Best Available Technology (BAT) and Best Not yet Available Technology (BNAT) that can be implemented on product or component level. The described BAT is in many cases already available on the market, but is less frequently used because of the purchase price. It partly provides the input for the identification of part of the improvement potential (task 7), i.e. especially the part that relates to the best available technology. In chapter 7, also cost, intellectual property and availability are taken into account for the selection of options. This is not the case in this chapter and many of the presented technologies are intellectual property or linked to individual companies. The input of this chapter is partially the result of an organised visit to the Light and Building trade fair in Frankfurt 2006 (see also chapter 9 stakeholder consultation). Much research is ongoing and information is not always publicly available, therefore this chapter can never claim to be complete but aims to give a general overview. For commercial reasons brand names are avoided in the text as far as possible.

6.1 BAT State-of the art in applied research

6.1.1 Luminaires with improved luminaire maintenance factor (LMF)

Luminaires with a low LMF will require an over dimensioning in performance, thus energy use, because the LMF depreciation factor must be taken into account when installations are calculated according to the EN 12464-1 standard series that specifies 'maintained' illuminance (see chapter 1).

Typical LMF values are specified in the CIE 97(2005) guide. In chapter 3, the typical values according to a cleaning cycle of 2 years are assessed as:

- 0.8 for category A1 luminaires
- 0.84 for category A2 luminaires

The CIE 97 guide also specifies the cleaning procedure for aluminium reflectors:

'Aluminium reflectors should be washed with a warm, soapy solution and rinsed thoroughly before being air-dried. Plastic opal or prismatic lenses should be cleaned with a damp cloth (using non-ionic detergent and water) and treated with antistatic polish or spray and allowed to dry'.

It should be clear that this not an easy job and in practice rarely done; this means that the cleaning cycle used in this study and during installation calculations is even optimistic, compared to common practice.



Figure 44: Luminaire with micro-optic refractor.

The technical solutions for an increase in LMF are:

- New enclosed IP2X refractor luminaires (see Figure 44) that can be easily cleaned. Especially micro-optic refractors are attractive with nearly flat refractor surface. The nearly flat refractor surface is needed in order to avoid the accumulation of dirt and to facilitate cleaning. IP2X luminaires have an LMF = 0.83 for category A1. Please note that refractor luminaires can have a reduced DLOR so that the overall energy saving is not guaranteed.
- New self cleaning reflector design.
- It is possible that LMF values are lower in the near future compared to the published values in CIE 97(2005) due to the banning of smoking in most offices.
- During the stakeholder workshop on 2 April 2007 it was stated that an LMF of 0.95 at 4 years can be achieved.

6.1.2 Luminaires with daylight responsive dimming

When luminaires are equipped with a light responsive sensor (see Figure 45), energy can be saved due to daylight responsive dimming. Energy saving values are estimated in chapter 3 for daylight responsive dimming. Please note that this can also be realised at building or systems level, when a building management system is used. Energy can only be saved in the proximity of windows (typically 3 m), see related discussion in chapter 3.



Figure 45: Luminaire with daylight responsive sensor

The technical solutions are:

- A dimming ballast (this is a prerequisite!).

- Installation of either light responsive sensors or an interface to a building management system that provides daylight information.

Conclusion:

This solution can provide the estimated BGF daylight savings from chapter 3. Savings that will be further used in this study are summarized in section 6.1.7.

6.1.3 Luminaires with dimming ballasts that compensate for luminaire pollution or room surface reflection deviations over its lifetime

It is useful to compensate for the luminaire pollution over its lifetime. This is done by taking into account the so-called luminaire maintenance factor LMF for calculating the 'maintained illuminance' (EN 12464-1). Dimming provides the possibility to save energy on new installations or on installations that are just cleaned, because then the light output is higher than needed. This saving can be approximately estimated as half the losses due to LMF or $BGF = 1/(1-(1-LMF)/2) = 1.11$.

It is also useful to compensate for deviations in the room surface reflection or pollution (RSMF), especially for small offices. Actual savings are not accounted for in this study because in practice there are no in the field compensations done for miscalculated installations due to deviations in room surface reflections.

The technical solutions are:

- A dimming ballast (this is a prerequisite!).
- Installation of either light responsive sensors or a timer circuit (in the luminaire) that increases light output over time to compensate for luminaire pollution.

Conclusion:

Energy can be saved and dimming ballasts are prerequisite ($BGF = 1.11$).

Savings that will be further used in this study are summarized in section 6.1.7.

Please note that the benefits are lower when improvement option in section 6.1.1 is implemented.

6.1.4 Luminaires with presence detection

When luminaires are equipped with a presence detector (see Figure 46) energy can be saved thanks to absence detection; energy saving values are estimated in chapter 3. Please note that this can also be realised at building or system level when a building management system is used with presence detectors. Please note that motion sensors exist with very low standby losses (< 2 mW), therefore no extra standby losses will be taken into account.



Figure 46: Luminaire with presence detector incorporated(left) and typical passive infra-red motion detector (right)

The technical solutions are:

- Installation of either motion detectors (e.g. passive infrared) in the luminaire or a building management system that provides the same presence detection function.

Conclusion:

This solution can provide the estimated BGF energy savings from chapter 3.

6.1.5 Improved fluorescent lamp types

History of fluorescent lighting:

Fluorescent lamps are a mature product. However, differentiation in performance is still found for products on the market. The technology is explained hereafter.

A fluorescent lamp is a low pressure gas-discharge lamp that uses electricity to excite mercury vapour in argon or neon gas. This results in a plasma that produces short-wave ultraviolet light. To convert this UV-radiation into visible light, a phosphorous layer is applied at the inside of the glass tube. Mercury is an essential ingredient in fluorescent lamps. Unlike incandescent lamps, fluorescent lamps always require a ballast to regulate the flow of power or current through the lamp.

The earliest ancestor of the fluorescent lamp is probably the device by Heinrich Geissler who, in 1856, obtained a bluish glow from a gas which was sealed in a tube and excited with an induction coil. In 1926, Edmund Germer and co-workers proposed to increase the operating pressure within the tube and to coat the tube with fluorescent powder which converts ultraviolet light emitted by an excited plasma into more uniformly white-coloured light. Today Germer is recognized as the inventor of the fluorescent lamp.

Instant start fluorescent tubes simply use a voltage, high enough to break down the gas and mercury column and thereby to start arc conduction. In other cases a combination of filament/cathode at each end of the lamp is used to "preheat" the filaments, typically between 0.5 and 1 s, prior to striking the arc. This extends the lumen maintenance and life time of the lamp. Particular types of electronic ballasts have been designed to start the lamp instantly,

typically there is a reduction of 25 % lamp life based upon 3 h per start operation (Lighting handbook, 1995).

Fluorescent lamps are sold in various shapes and bases (sockets). In office lighting Tubular (T) shapes are most frequently used. Nowadays, most common, typical diameters are T8 (25 mm) and T5 (16 mm); the T12 (38 mm) diameter lamp is outdated and only recommended for special low temperature applications.

At the advent of fluorescent lamp technology, halo-phosphor (calcium halo-phosphates) coated fluorescent tubes were introduced (chemical formula $\text{Ca}_5(\text{PO}_4)_3(\text{F},\text{Cl}):\text{Sb}^{3+},\text{Mn}^{2+}$). These lamps have a continuous line of spectra. There is an important presence of prominent blue and green lines emitted directly by the mercury arc and in part to the type of phosphor used.

An increasingly popular approach of blending of phosphors for fluorescent lamps is the tri-phosphor system, based on europium and terbium ions, that have emission bands more evenly distributed over the spectrum of visible light. In addition, these relative new phosphors are very stable under intensive UV radiation, allowing for the construction of more compact lamps (e.g. T8 instead of T12) with higher efficacy and lumen maintenance. These phosphors can give a more natural colour reproduction to the human eye. Also a variety of lamp types did become available which generates radiation in particular wavelength regions for special purposes, such as: plant growth, merchandise enhancement, etcetera.

There is an optimum diameter for the lamp (Lighting handbook, 1995). In lamps of small diameter, an excessive amount of energy is lost by recombinations of electrons by ions at the bulb wall. In lamps of large diameter, losses due to 'imprisonment of radiation' becomes larger. The length of a lamp influences its efficacy (Lighting handbook, 1995), the greater the length the higher the efficacy (see also data in chapter 4). This is due to an almost constant loss in the electrodes and partly to energy loss, directly associated with the light generation.

Description of BAT:

There is a large temperature effect on operation. The characteristics of a fluorescent lamp are very much dependent upon the concentration of mercury vapour or its pressure in the lamp which depends upon temperature. The excess mercury tends to condensate at the coolest point or 'cold spot' on the lamp that determinates the mercury pressure (see also chapter 3). The cold spot temperature in turn depends upon lamp construction, lamp wattage, ambient temperature, luminaire design and air flow. The effect of temperature on the mercury vapour manifests itself as variations in light output and colour (Lighting handbook, 1995). Lamps using mercury amalgams are available for extending the usable ambient temperature range to higher values. More recently, new T5 lamps with a special amalgam compound were introduced. That new compound enables them to maintain 90% of the full lumen output through a wide range of temperatures (see Figure 47).

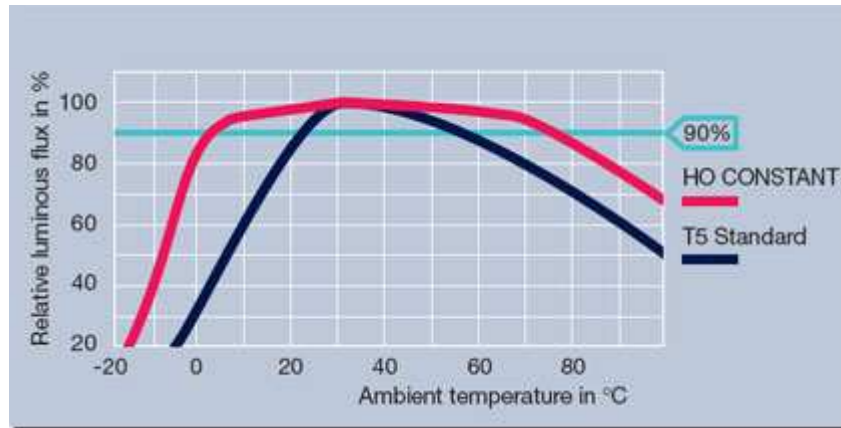

Figure 47: Influence of ambient temperature on luminous flux of T5 HO constant lamps, compared to T5 standard lamps.

A large improvement in lamp efficacy can be obtained with high-frequency operation of fluorescent lamps. A typical 10 % efficacy gain (p. 209, Lighting handbook, 1995) can be obtained by operating the lamp above 10 kHz compared to 50 or 60 Hz line frequency operation. The advent of electronic ballasts enables high frequency. Electronic ballasts are intrinsic more efficient compared to electromagnetic ballasts and electromagnetic ballasts can never close the gap in energy efficiency. The high-frequency mode results in low power loss at the cathodes which means that more power is available in the arc. Furthermore the reduced power in the arc of lamps operated on HF ballasts results in a lower lamp wall loading and improved lumen maintenance (LLMF). Please note that there is a standard that specifies the requirements for electronic ballasts (IEC 60929): 'AC supplied electronic ballasts for tubular fluorescent lamps - performance requirements'; this standard includes functional performance requirements for starting, operating, circuit power factor, lamp operating current waveform, operational tests for abnormal conditions and endurance. Some new types of electronic ballasts have a 'multi-watt' function, this means that they can be used for several lamp wattages. This multi-watt function could also be useful to allow the use of a lower power lamp and can provide therefore additional means for energy saving, if the lamp fits in the base of the luminaire.

Unlike incandescent lamps, fluorescent lamps cannot be properly dimmed with a simple wall box device such as those used for incandescent lamps. To dim a fluorescent lamp over a full range without a reduction in lamp life, its electrode heater voltage must be maintained while the lamp arc current is reduced. The power required to keep electrode voltage constant over all dimming conditions means that dimming ballasts will be less efficient when operating lamps at dimmed levels.

Also, special provisions are needed in order to avoid 'striations' when lamps are dimmed to very low power levels (e.g. below 10 % for T5 LFL lamps) and at low temperature; 'striations' are a series of bright and dim areas in fluorescent lamps. At room temperatures, dimming can be realized up to 1% without problems when special techniques are used. Related problems to striations were first solved by a patent, filed in 1989 (US patent 5,001,386): 'A small amount of dc current is simultaneously provided to the lamp, the resultant asymmetric current waveform

flowing through the lamp substantially eliminates striation over a dimming range from about 100% to 1% of full light output'. This patent expires in 2009 and further price drops for electronic dimming ballasts can be expected from 2010 on. This small DC current injection could affect lamp life; no large scale data are known. In June 2005, the Lighting Research Centre (US) initiated one of the largest independent studies of fluorescent dimming systems to date. Over the next three to five years, the LRC will run a life-test study to investigate the performance of linear fluorescent lamps on a wide range of dimming ballasts, testing more than 850 systems in all. According to ELC (stakeholder remark anno 2007) dimming has no influence on the lamp life.

Please note that the luminous efficacy of the lamp-ballast combination is slightly reduced at dimmed light output, e.g. by 0.87 (70 at 50 % luminous flux/80 at full power (Roisin, 2007)).

CFL lamps have bended discharge tubes, the operation principle is the same but they are intrinsic less efficient compared to LFL due to internal absorption on the opposite tube.

The most efficient electronic ballasts have 'cut-off' technology incorporated, with 'cut-off' technology the lamp filament preheating is switched-off after ignition of the lamp. This ballasts have 5 to 7 % more efficiency or 2 to 3 W per lamp, they are typical the CELMA EEI = A2 ballasts. CELMA level EEI = A3 ballast often don't have this technology and are more compact. Magnetic ballasts have 'cut-off' technology enforced by the principle.

Conclusions:

- Halophosphate lamps are less efficient compared to tri-phosphor lamps and have lower lumen maintenance (see chapter 4);
- Efficacy is related to length, lamp power and colour (see chapter 4);
- Fluorescent lamps can be dimmed up to 1 % light output;
- High frequency electronic ballasts are intrinsically more efficient and BAT (see chapter 4);
- Electronic ballasts are highly standardized (see chapter 1);
- From 2010 on, further price drops can be expected for full range (1-100%) dimming ballasts.
- CFL lamps are intrinsic less efficient compared to LFL due to internal absorption on the opposite tube.
- The most energy efficient ballasts have 'cut off' technology, this means switching off the filament preheating after ignition.

6.1.6 Improved efficiency for electronic ballasts compared to CELMA EEI = A2 & A1

It is possible to further increase the efficiency of electronic ballasts compared to reference levels specified in the 2000/55/EC on energy efficiency requirements for ballasts for fluorescent lighting and the complementary CELMA classification system (see chapters 1 and 4).

The technical solutions were:

- The use of new semiconductors with reduced conduction and switching losses;

- The reduction of losses in high frequency coils and transformers. This can be done by applying low loss ferromagnetic materials and/or the reduction of magnetic field in coils by using larger cores. Also Litz copper wires can be used;
- Incorporating improved low power control semiconductor circuits (e.g. microprocessors, power factor corrector circuit, ..);
- Operate more than one lamp simultaneously.
- 'Cut-off' technology can provide the additional savings for BAT levels. With 'cut-off' technology the lamp filament preheating is switched-off after ignition of the lamp. This ballasts have 5 to 7 % more efficiency or 2 to 3 W per lamp, they are typical the CELMA EEI = A2 ballasts. CELMA level EEI = A3 ballast often don't have this technology and are more compact. Magnetic ballasts have 'cut-off' technology enforced by the principle.

Semiconductor industry stated in the stakeholder workshop on 2 April 2007 that future ballast design improvements can still be expected (e.g. reduction of switches), also ballast failure rate will be further decreased.

Table 87: Overview BAT values EEI-class A1 & A2 ballasts (catalogue research).

lamp	ILCOS	EEI class	$\eta_{ballast}$	$\eta_{ballast}$ BAT	price increase ballast (OEM)	price increase ballast (replacement)
2xLFL T8-36W	FD-36-E-G13-26/1200	A2	0,89	0,94	+1	+2
3xLFL T8-18W	FD-18-E-G13-26/600	A2	0,76	0,91	+1	+2
2xLFL T5-28W	FDH-28-G5-L/P-1150	A2	0,87	0,92	+1	+2
3xLFL T5-14W	FDH-14-G5-L/P-550	A2	0,82	0,89	+1	+2
1xLFL T5-54WHO	FDH-54-G5-L/P-1150	A2	0,9	0,9	+1	+2
2xLFL T8-36W	FD-36-E-G13-26/1200	A1	0,8	0,86	+1	+2
1xLFL T8-36W	FD-36-E-G13-26/1200	A2	0,84	0,91	+0,5	+1
1xLFL T5-14W	FDH-14-G5-L/P-550	A2	0,82	0,85	+0,5	+1
1xLFL T8-36W	FD-36-E-G13-26/1200	A1	0,8	0,84	+0,5	+1

Conclusion:

Significant higher efficiencies compared to level A1 and A2 are possible.

The most energy efficient ballasts have 'cut off' technology, this means switching off the filament preheating after ignition. These ballast have a larger volume.

Electronic ballast efficiency is more related to the total lamp power than to the individual lamp power, this accounts when a ballast operates more than one lamp simultaneously.

6.1.7 Electronic dimmable ballasts

Dimming ballasts are able to adapt the light level to the minimum required value and therefore to save energy. This technology is discussed in section 6.1.5.

Dimming can provide energy saving thanks to daylight and luminaire maintenance factor compensation as discussed in sections 6.1.2 and 6.1.3.

It is also possible to save energy when a lower illuminance set point is accepted by the user or when the task area is modified in the office. The illuminance requirement in office rooms on the task area is 500 lx (see chapter 1) and 300 lx in the immediate surrounding area. Therefore energy can be saved if every luminaire can be individually dimmed by the user and 300 lux is the default set point that can be increased when needed, see Table 53.

Conclusion:

In the next table all this dimming options are combined with solutions of sections 6.1.2 and 6.1.3 and Table 53. These values will be used in further chapters in this study.

Table 88: BGF data for dimming options

control method	BGF	BGF
	cellular office	open plan office
daylight responsive dimming including LMF&RSMF compensation	1,96 (=1,77 x 1,11)	1,53 (=1,38 x 1,11)
Manual dimming control & daylight responsive dimming including LMF&RSMF compensation	2,26 (=1,15 x 1,77 x 1,11)	1,76 (=1,15 x 1,38 x 1,11)
Manual dimming control	1,15	1,15
Manual dimming control & daylight responsive dimming not including LMF&RSMF compensation	2,03 (=1,15 x 1,77)	1,59 (=1,15 x 1,38)
daylight responsive dimming not including LMF&RSMF compensation	1,77	1,38

6.1.8 High reflectance aluminium material

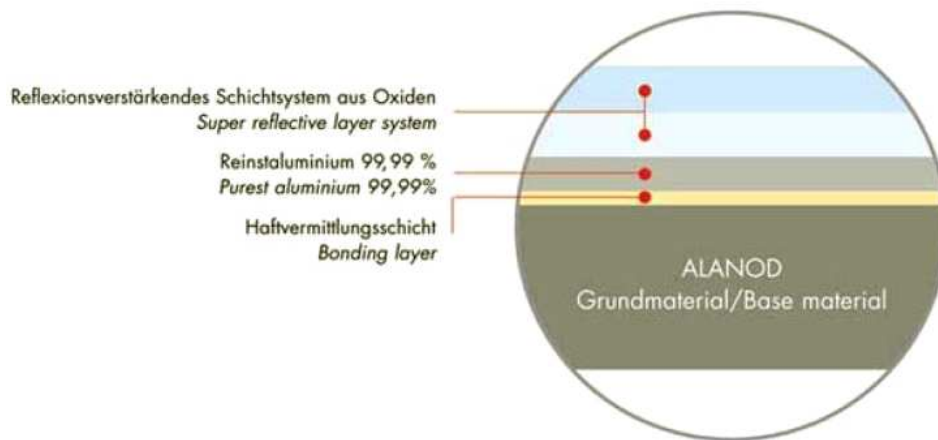

Figure 48: Multi-layer structure of high reflective aluminium

Aluminium reflectance can be increased using advanced multi-layer coating techniques (Figure 48). Normal anodised aluminium for lighting applications has a total reflectivity of up to 87%. To increase or enhance this total reflectivity to a higher level, several nanometre-thin optical coatings must be applied to the aluminium surface in a vacuum. The principle of multi-layer thin film coatings is widely known in physics but the production of this material for aluminium lighting reflector applications is almost exclusively done by one company. This company sells pre-treated multi-layer aluminium coils with specular and diffuse surfaces and 95% total reflectivity. This highly reflective surface allows the lighting manufacturer to achieve 5 up to 15 % increase in Light Output Ratio (LOR or CEN flux code). The process for creating reflectors with this aluminium is also more expensive because careful assembly is required to avoid surface damage (scratches) and therefore important shaping of this material is not possible. (Anodization of ordinary aluminium can be performed after shaping and assembly of the reflector and is less expensive.) In Europe many high performing luminaires are using this material, especially for indoor lighting.

Conclusion:

LOR can be improved with 5 up to 15 % when applying multi-layer high reflective aluminium. Luminaires with this technology were included in the luminaires that were assessed for UF and CEN flux code in chapter 4, therefore this reflector technology was implicit taken into account in chapter 4.

6.2 State-of the art of best existing product technology outside the EU

The EU has premises of leading international companies in the field of lighting with also important R&D related to office lighting within the EU. For the cited BAT above, similar technology exists around the world, mainly in the US and in Asia. Many companies are

internationally active and it is difficult to allocate their activities and achievements exclusively to the EU.

On the longer term (above 5 years), the proliferation of more advanced electronic ballasts and solid state lighting such as LEDs could be allocated to new product technology resulting from Asian developments (actually mainly at electronic parts production level).

6.3 BNAT in applied research

6.3.1 New luminaires for WLED SSL lamps

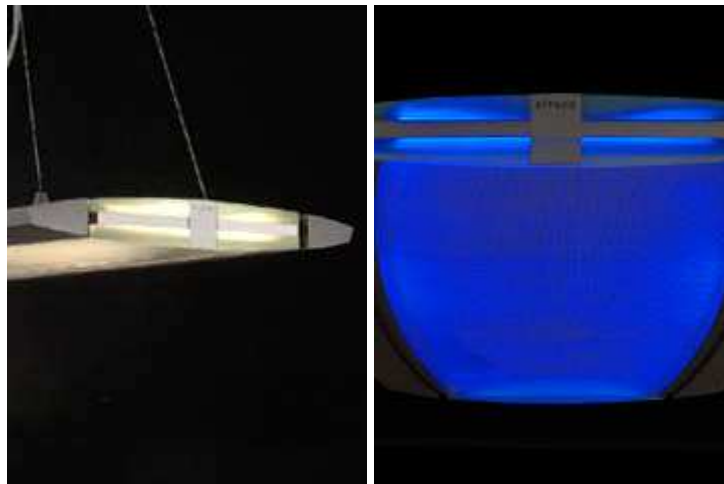

Figure 49: Office lighting luminaire with LEDs

WLEDs (White LED) SSL (Solid State Lighting) are a new upcoming technology, see 6.3.3. WLED luminaires are considered BNAT in the scope of this study concerning general office lighting illumination for reasons mentioned in 6.3.3. At prototype level some manufacturers are developing WLED lamp luminaries that can be used in office lighting (Figure 49). The application of WLEDs will require new specific expertise to luminaire designers (Ahun (2007)). The WLED technology is still not mature for application in general illumination (Ahun(2007)) because of its lower efficacy, the performance stability in relation to lifetime and temperature, the colour consistency and the colour quality of a single WLED.

LEDs cannot suffer high operational temperatures and are by consequence only available in relative low power (1 to 3 Watt) compared to fluorescent lamps. Luminaire design will also be influenced by integrated cooling features. A typical WLED luminaire could therefore be composed of a series of low wattage WLEDs that are distributed over a wide surface that provides good cooling.

A back reflector is not required for LEDs because they have an hemispherical radiation pattern ('LED Quarterly Insights: white LEDs', IOP, London, 2006).

WLED's can easily be dimmed and it is also possible to combine them with coloured LED's. Interesting suspended luminaires are developed that are able to modify the colour of the indirect light to the ceiling. The LED's can appear as small light spots, creating an interesting

play of light. Warm-white direct light is emitted directly into the room. A cool, indirect light component is directed upwards via a frosted, translucent diffuser.

Conclusion: This technology is only considered as BNAT because it is related to the availability of WLED's (see 6.3.3).

6.3.2 New luminaires for OLED lamps

OLEDs (Organic LED) are a new upcoming technology, see 6.3.4. OLED luminaires are considered BNAT in the scope of this study concerning general office lighting illumination for reasons mentioned in 6.3.4. This technology is intrinsically well suited for indoor area illumination; there are no prototypes for office lighting known but lighting could appear as 'glowing wall paper' without the need for 'luminaires'. More info on OLED see section 6.3.4.

6.3.3 WLED SSL lamps



Figure 50: Typical WLED

White-light emitting diode (WLED) solid state lighting (SSL) lamps (Figure 50) are recently becoming available on the market with increasing efficacy (up to 94 lumen/W ((Härle (2007))) and increasing life time as a result of decades of semiconductor research and progress. WLED are part of ultra-brite (UB) LEDs that include also coloured LEDs. WLEDs are nowadays especially applied where small white light sources are needed, e.g. in display backlighting of portable devices. Also applications where coloured light is required benefit from LED's, e.g. traffic and other signs (applications with a low power density). LED's can be dimmed easily. WLED's are available in a wide range of lamp efficacies (5-80 lumen/W) even from the same manufacturing production line, the LEDs have to be sorted during manufacture by their actual characteristics.

WLED's that are nowadays on the market are mainly Solid State Lighting (SSL) devices, that rely on semiconductor material. For this SSL technology, efficacy and life time rapidly decrease with ambient temperature, therefore no high power densities or compact light sources can be obtained. SSLs are therefore primarily produced as discrete devices they are mainly available in low wattages (typical 1 to 5 Watt) and the main market products nowadays are mobile appliances (48 % in 2006, Steele (2007)). They are also sold as multiple LED packages for signalisation applications.

Dr. Shuji Nakamura of Nichia of Japan is the inventor of the white LED which took a composite YAG phosphor coating on top of a blue LED and converted it to white light. This

technique is nowadays nearly used by all WLED manufacturers. A theoretical limit in efficacy can be expected in the range of 135-150 lm/W with lens and without converter (Härle (2007)). The spectrum of some white LEDs differs significantly from incandescent light. There is a strong dependency of maximum efficacy on colour temperature colour coordinate (up to 20% increase) (Härle (2007)). The most efficient WLEDs appear blue (e.g. CT 6000 K) and do not meet the CRI > 80 colour rendering requirement for office lighting (EN 12464-1).

The SSL dependence on solid state semiconductor material could keep the price relatively high for these sources and the environmental impact of the production should be followed up in the near future. LED semi-conductors are crystals comprised of combinations of typically two or three inorganic elements, such as gallium phosphide (GaP), gallium nitride (GaN), gallium indium nitride (GaInN) or gallium indium phosphide (GaInP). It should be noted that LEDs in general, thus not only WLED, are included in the environmental impact unit indicators in the MEEUP methodology report (table 29 material 48) and herein the production energy requirement or GWP per kg is very high compared to other materials. This can be explained by the high energy (GWP) and environmental that is typical for the production of semiconductor material, see also material 47 (ICs SMD) in table 29 in the MEEUP methodology report. The WLEDs in particular make use of the rare raw materials gallium and indium that are used in many other high tech applications (PV panels, monitors, LCD displays with coatings of indium tin oxide) ('Only united are we strong: supply problems await areas other than silicon', Photon International, July 2006). The world annual indium production was estimated(2005) at 455 ton at 650 €/kg with about 600 ton global reserves only(US Geological Survey, Mineral Commodity Summaries, January 2006). The indium price did rise with a factor 8 from 2002 to 2005. The world annual gallium production is estimated in 2005 at 208 tons at 410 €/kg and the global reserve is more difficult to estimate. Gallium occurs in very small concentrations in ores of other metals and is produced as a byproduct (e.g. bauxite). Based on the world resource of bauxite the reserve exceeds 1 million ton but probably only a small percentage of this metal is economically recoverable (US Geological Survey, Mineral Commodity Summaries, January 2006). The required energy (GWP) and material for the particular high efficacy WLEDs can only be modelled very approximate nowadays because it is unclear how many % of the production reach the high efficacy rating and there are many different and new production processes involved from which no data is made available due to intellectual property concerns.

Conclusion:

For spot lighting or signs where coloured lights are required, LED's are the technology of choice. Compared to fluorescent lamps the price of WLED's is very high and lumen output still poor. It remains very difficult to predict if and when WLEDs will be applied in general office lighting. WLED technology has therefore been classified as BNAT for office lighting applications.

It is difficult to calculate future price drops for SSL technology and it is also difficult to model more accurately the environmental impact compared to the unit indicator (material 48) in the MEEUP methodology (table 29). It is also clear from the unit indicator in the MEEUP methodology that environmental impact from the production may not be neglected in future assessments.

There will be no case study for LED's in this study because the current efficacies of warm white WLEDs with good colour rendering is significantly lower (30 lm/W for LEDs versus 90

lm/W for fluorescent lamps anno 2006) and the price per lumen is significantly higher (30 lm/euro for LEDs versus 1620 lm/euro for fluorescent lamps anno 2006).

On one hand this new UB LED technology offers a new functionality (e.g. in decorative lighting) that might increase lighting application and hence total energy consumption but on the other hand it offers the possibility to replace existing applications with more energy efficient ones, but in 2007 not yet in office lighting.

6.3.4 OLED lamps

OLEDs (Organic Light-Emitting Diodes) are a flat display technology (Figure 51), made by placing a series of organic thin films between two conductors. When electrical current is applied, a bright light is emitted. OLED's could tackle in the future the material and cost problem currently encountered in SSL LED's. The first OLED's are already on the market for particular, very flat illuminated displays in portable devices. OLED's based on organic material are still part of current R&D. OLED efficiencies under particular operational conditions have been reported up to 64 lm/W at 1000 Cd/m² (Budde (2007)). The actual OLED's still have a too efficacy for office lighting applications in working conditions (e.g. temperature and required life time).

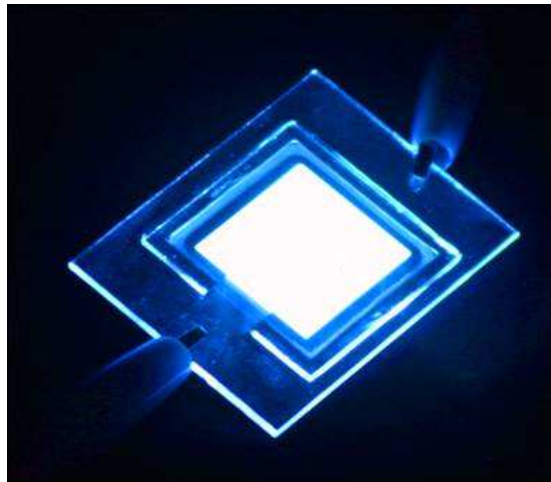

Figure 51: OLED prototype (Picture courtesy of OLLA project)

Conclusion:

The OLED performance is actually still far from what will be required for office lighting. In office lighting a typical efficacy is 90 lm/W with a typical office desk luminance of 100 cd/m², a reported efficiency of 64 lm/W at 1000 Cd/m² at the light source under particular operational conditions in 2006 is therefore still too low, but future development might overcome this hurdle. OLED's are classified therefore BNAT and there will be no case study for OLED's in further chapters.

7 IMPROVEMENT POTENTIAL

The importance of assessing the improvement potential is addressed in Article 15 c of the 2005/32/EC Directive. It says that *‘the EuP shall present significant potential for improvement in terms of its environmental impact without entailing excessive costs, taking into account in particular the absence of other relevant Community legislation or failure of market forces to address the issue properly and a wide disparity in the environmental performance of EuPs available on the market with equivalent functionality’*. (Source: MEEUP report)

As mentioned this indicates that costs, existing Community legislation and self-regulation as well as the environmental performance and functionality of a wider range of the existing EuP need to be assessed.

What “costs” entail is indicated in Article 15 c, imposing that the implementing measure shall not have a significant negative impact on

- a) the functionality of the product for the user;
 - b) health, safety and the environment;
 - c) the affordability and life cycle costs to the consumer;
 - d) industry’s competitiveness.
- as well as not leading to
- e) imposing proprietary technology or;
 - f) an excessive administrative burden for industry.

The boundary conditions a) and b) are to be defined per product to a large extent in harmonised EN standards to provide an objective basis for assessment. conditions. Condition e) is relatively easy to assess from desk-research and discussions with stakeholders. The question of which characteristics of an implementing directive would create ‘an excessive administrative burden can only truly be established *ex-post* if one or more proposals for legislation are known. Which leaves us with two conditions c) and d), which are –in part— linked and which play a key role in the methodology that will be discussed hereafter.

Identify design options, their monetary consequences in terms of Life Cycle Cost for the consumer, their environmental costs and benefits and pinpointing the solution with the Least Life Cycle Costs (LLCC) and the Best Available Technology (BAT). The assessment of monetary Life Cycle Costs is relevant to indicate whether design solutions might negatively or positively impact the total EU consumer’s expenditure over the total product life (purchase, running costs, etc.). The distance between the LLCC and the BAT indicates —in a case a LLCC solution is set as a minimum target— the remaining space for product-differentiation (competition). The BAT indicates a medium-term target that would probably be more subject to promotion measures than restrictive action. The BNAT (subtask 6.5) indicates long-term possibilities and helps to define the exact scope and definition of possible measures.

7.1 Improvement options with cost and impact assessment

Scope: Identification and description of design options for environmental improvement with a quantitative assessment of estimated cost impact and the environmental improvement using the EuP EcoReport.

The Base case life cycle cost is calculated using the next formulas:

$$LCC = PP + PWF * OE,$$

where,

LCC is Life Cycle Costs,

PP is the Purchase Price (see also chapter 2 and 4),

OE is the Operating Expenses per year,

PWF (Present Worth Factor) is $PWF = \{1 - 1/(1+r)^N\}/r$,

N is the product life (see also chapter 2 and 3),

r is the discount (interest-inflation) rate (see chapter 2).

Detailed information about the improvement options can be found in complementary MEEUP EcoReports (in Microsoft Excel format) that are published on the website <http://www.eup4light.net> for each improvement option. The input parameters are the defined performance and cost parameters in chapters 1, 2, 3 and 4. Stakeholders can use these excel spreadsheets for assessing and verifying the options.

For each option we also calculate the Functional Unit (useful lumen only) together with Energy use per product life per functional unit (kWh/(y.lm)) and LCC per functional unit (€/lm). These calculated values will serve in section 7.3 for the Least Life Cycle Cost and BAT analysis.

In the following subsections under section 7.1: 15 individual improvement options are discussed for office lighting. In principle, these can be grouped as:

1. Design options relating to the lamp
2. Design options relating to the ballast
3. Design options relating to the luminaire

Given that these components are also used in non office lighting equipment; the possible impact on other non-office market segments will be discussed qualitatively in chapter 8.

Improvement options should in first instance be beneficial regarding energy efficiency since this causes the main contribution in the total life cycle of the office lighting products (both in terms of environmental impacts as costs). These same options are however also beneficial towards materials efficiency (reduced product weight, less mercury content, less impact from materials in the BOM, etcetera...). This is discussed in the following subsections.

Please note that 'improvement' options are connected to the performance of the base case (see chapter 5). Because the base case is not the 'worst case' product performance, some product

features are not an 'improvement' option. In order to discuss the product requirements in this study also a worst case option 1 is introduced in this study. The worst case option 1 has a poorer performance compared to the base case.

7.1.1.1 Worst case option 1: replace halophosphate with triphosphor lamps

Please note that this option is a 'worst cast' option as explained in the previous chapter.

The first and most obvious improvement is the elimination of fluorescent lamps with poor efficacy. From chapter 4 it can be deduced that halophosphate lamps have a significant lower efficacy compared to triphosphor lamps. Halophosphate lamps are not used in the base cases because these lamps do not satisfy the minimum colour rendering criteria imposed by standard EN 12464 ($R_a \geq 80$). This option 1 is by consequence a 'negative' option to compare it with the better standard base case.

Substituting halophosphate with triphosphor lamps also reduces mercury use and potential emissions; with typical mercury content of 10 mg compared to 5 mg per lamp respectively. Because triphosphor lamps have a higher performance compared to halophosphate lamps of the same wattage, material savings can be achieved at installation level: less luminaires are required per m² office surface.

Note that these halophosphate lamps are also often used as replacement lamp for originally triphosphor luminaires. This doesn't affect total energy use, but reduces luminaire performance (reduced illuminance).

This option is implemented for base case luminaires A1 (direct lighting, cellular and open plan offices) that use T8 LFL's.

7.1.1.2 Option 2: minimum ballast EEI-class set to B1

For fluorescent lighting ballasts; Minimum Energy Performance Standards (MEPS) are already introduced by Directive 2000/55/EC on 'energy efficiency requirements for ballasts for fluorescent lighting' (see chapter 1). Currently, (>2005) the minimum level is EEI-class B2.

In this option 2, we substitute magnetic ballast of EEI-class B2 with a magnetic ballast of EEI-class B1. This increases the energy efficiency of the lamp ballast combination (see table 11, chapter 3 for η ballast values).

Because luminaires equipped with a B1 ballast have a higher functional output compared to luminaires with a B2 ballast, material savings can be achieved at installation level: less luminaires are required per m² office surface. Part of this material saving is however compensated because B1 ballasts are generally heavier compared to B2 ballasts, mainly due to a higher copper content (see Table 57).

7.1.1.3 Option 3: minimum ballast EEI-class set to A2

In this option 3, magnetic ballast of EEI-class B2 in the base cases are substituted with electronic ballasts of EEI-class A2. This further increases the energy efficiency of the lamp

ballast combination (η_{ballast}), but also influences and increases the energy efficiency of the lamp itself ($\eta_{\text{lamp@50Hz}}$). The lamp efficiency increases with high frequency operation and this is only possible with an electronic converter (see table 13, chapter 3 for values).

7.1.1.4 Option 4: minimum ballast EEI-class set to A2, BAT

In this option 4 there is a switch to improved efficiency levels for electronic ballasts according to the BAT levels from section 6.1.6.

7.1.1.5 Option 5: minimum stand-by losses for electronic ballasts of EEI-class A1

For more information please consult the related EuP study on standby and off-mode losses (lot 6).

Please note that this study included standby losses from Table 65 for dimming ballasts (Pci).

7.1.1.6 Option 6: improved luminaire maintenance factor (LMF) at 4 years

This option is related to the BAT improvements that are defined in section 6.1.1. In this option the best value (LMF =0.95) is used for all categories. An extra cost for the luminaire was added (+ 10 euro).

Table 89: LMF data for option 6

	base cases	Option 6
maintenance period (y)	2	4
LMF	0,8 (A1) - 0,84 (A2)	0,95

7.1.1.7 Options 7, 9 to 12: minimum ballast EEI-class set to dimmable electronic A1

In the following 5 options it is assumed that all office luminaires are equipped with electronic dimmable ballasts of EEI-class A1. These dimmable ballasts are assumed to provide saving by and/or the following control options: daylight responsive dimming, dimming to compensate for the luminaire maintenance factor (LMF), manual dimming control to adjust to lower or higher lighting levels. All these options are defined and discussed in section 6.1.7 and the ballast gain factors (BGF) are given in Table 88. In chapter 4 (Table 65) the cost for EEI-class A1 ballasts are given. In addition to this, also the cost for an extra sensor or interface is taken into account in the purchase prices: options 7 and 12 (+15 €), 9 and 11 (+20 €), 10 (+5 €).

Table 90: Control methods considered for options 7 and 9 to 12

Control method	Daylight responsive dimming	Manual control	dimming	LMF & RSMF compensation	BGF (cellular offices)	BGF (open offices)
Option 7	X			X	1,96	1,53
Option 9	X		X	X	2,26	1,76
Option 10			X		1,15	1,15
Option 11	X		X		2,03	1,59
Option 12	X				1,77	1,38

7.1.1.8 Option 8: improved optic luminaire efficiency

In section 4.3.1.5 (see Table 70) the UFr values for a sample of existing luminaires on the market are listed. In this option 8, the luminaires are excluded with a UFr that is lower than the 70% value between maximum and minimum UFr in the table. After implementation of this improvement option, the new median value for UFr (UFr BAT median) will be situated at the 85% value between highest and lowest performance of luminaires that are currently on the market. The price increase for the luminaires was estimated at € 50, based on the price variations for luminaires found in chapter 4.

Table 91: Data for option 8

luminaire category	Option 8: UFr BAT (formula)	Option 8: UFr BAT median (85%)	Base cases: UFr median (50%)
A1 cellular	$(0,68-0,31) \times 0,85 + 0,31$	0,62	0,49
A1 open plan	$(0,78-0,29) \times 0,85 + 0,29$	0,71	0,53
A2 cellular	$(0,54-0,31) \times 0,85 + 0,31$	0,51	0,42
A2 open plan	$(0,69-0,48) \times 0,85 + 0,48$	0,66	0,58

7.1.1.9 Option 13: substitution with luminaires that use smaller lamps

In this option luminaires with T8 lamps are substituted with T5 luminaires. An argument for doing this is the use of smaller lamps, consequently luminaires to reduce resources use. This option does not result in energy savings. From chapter 4, in particular Table 59 the weights and BOM are given for several T8 and T5 luminaires. Although up to 20% material savings can be achieved, when looking at the total life cycle impacts and emissions, this material reduction only translates into marginal impact reductions. This is because the environmental impact of the luminaire itself is relatively low (see Figure 43). The same goes for substituting LFL luminaires with CFL luminaires. Although CFL are less energy efficient as LFL luminaires, at installation level the energy use will not change substantially, but does generate reduction in materials and resources use.

7.1.1.10 Option 14: use of High Efficiency (HE) T5 lamps

Within the same technology or type of lamps, in this case T5 triphosphor fluorescent lamps, it is possible to trade-off between:

- T5 lamps with the same wattage, but with longer lamp length. Generally, the longer, the more energy-efficient (see section 6.1.5).
- T5 lamps with the same lamp length, but with higher efficiency (HE).

The second is simulated in this option 14 for category A2-luminaires: the 54 W T5 'High Output' (HO) lamp used in the A2-luminaire base case is substituted with a 28 W T5 'High Efficiency' (HE) lamp of the same lamp length (see Table 62).

Please note that high efficiency lamps were already assumed in the base case of category A1 luminaires (see chapter 5) and by consequence they are only a 'worst case' option as explained in the introduction of this chapter.

When shifting to lamps with a similar wattage but higher efficiency (lm/W) less luminaires are required per m² office surface. This option can thus indirectly generate material savings at installation level.

7.2 Analysis LLCC and BAT

Scope:

- Ranking of the individual design options by LCC;
- Identifying the Least Life Cycle Cost (LLCC) point and the point with the Best Available Technology (BAT).

Options are ranked according to electricity use (E_y) and compared to the reference base cases in Figure 52, Figure 53, Figure 54, Figure 55 and Figure 56. The energy efficiency is expressed as electricity use per functional unit 100lm (kWh/100lm); thus the lower the better. Option 13 was not included in these figures because it is not related to energy efficiency, its impact is very low (see 7.1.1.9) and was therefore not considered any more.

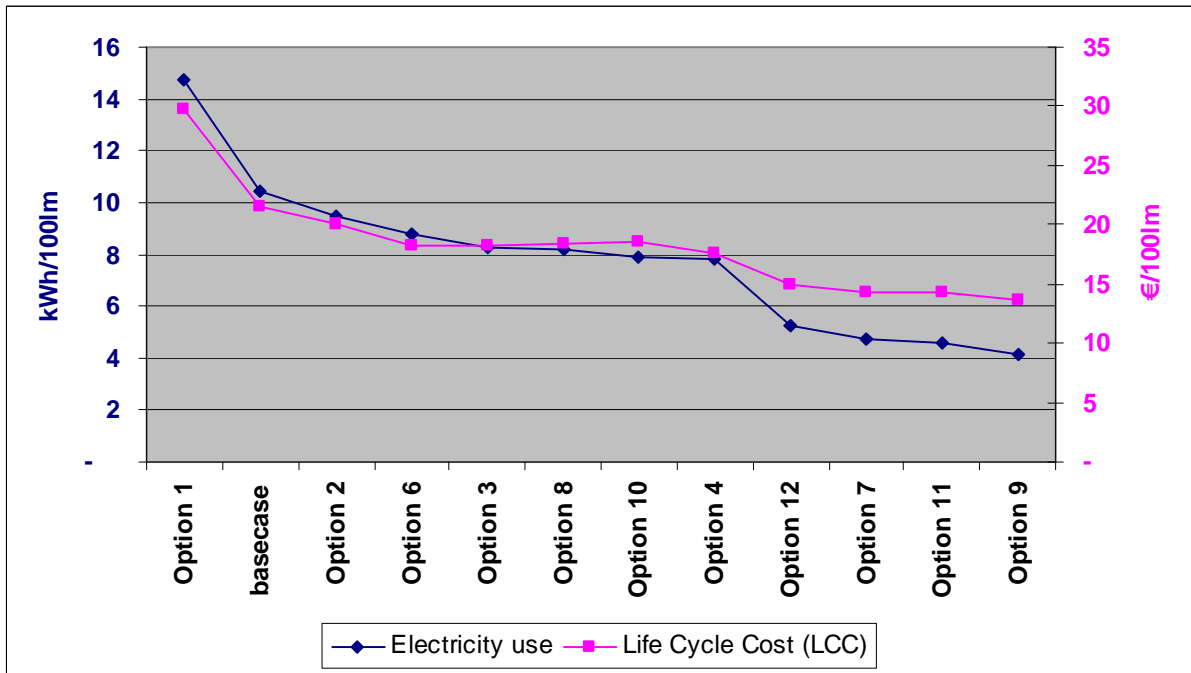

Figure 52: Ranking of options for type A1 luminaires in cellular offices

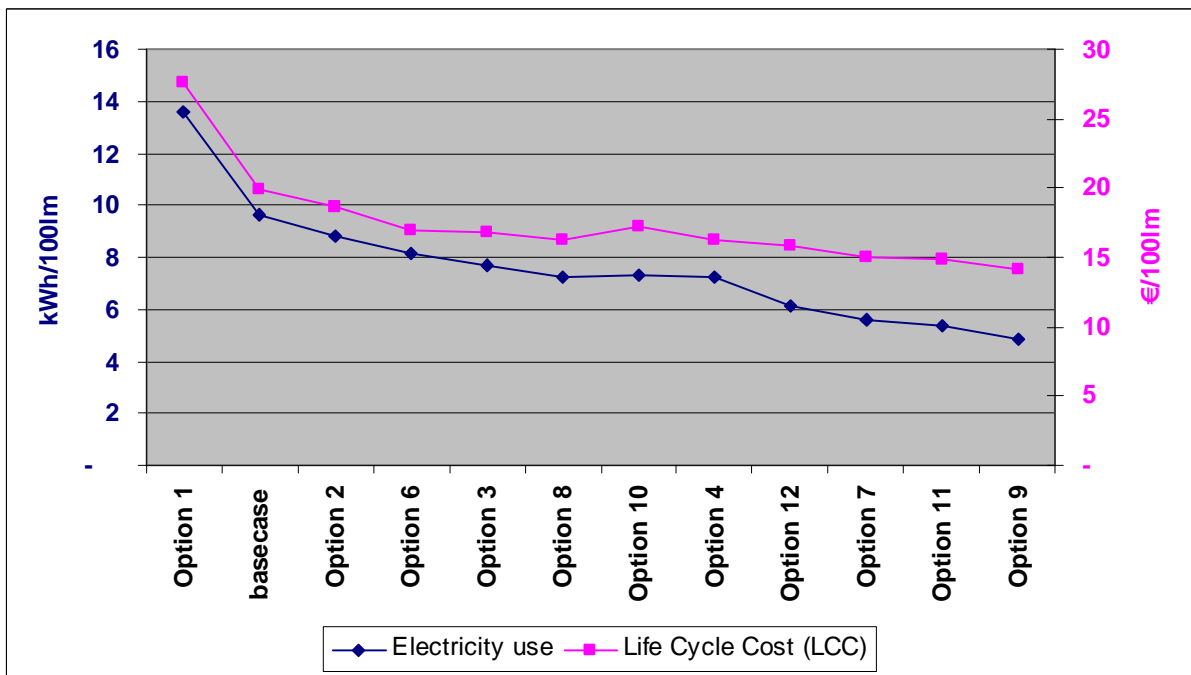

Figure 53: Ranking of options for type A1 luminaires in open plan offices

Ranking for both A1, open and cellular offices is similar regarding the order of the options.

Option 1 (halophosphate lamps) has a worse energy efficiency compared to the base case because the lamp is less efficient. This option was included to demonstrate the savings that can be realized by substituting to luminaires using triphosphor (both in terms of initial installation and lamp replacement during the luminaire operating time).

As can be concluded from Figure 52, Figure 53, the most substantial savings can be achieved by substituting halophosphate lamps with triphosphor lamps. In reality, and mainly for lamp replacement, halophosphates are still used today. Substantial savings can also be achieved by implementing EEI-class A1 ballasts with dimming control (daylight responsive, LMF compensation, individual light level control).

Options 8, 10 and 4 generate somewhat the same saving. For option 8 (setting minimum levels for UFr) this however strongly depends on the real UFr today. Little data is available on this issue. In this study, the median value 'UFr median' that was found from the technical analysis of luminaires conducted in the framework of this study (see section 4.3.1.5) is used for the base cases. For option 8, the average UFr value was set at UFr BAT median. The influence of the uncertainty regarding the real UFr data on the ranking of the individual options is discussed in section 8.1.3.1.

Option 9; implementing dimming with and daylight responsive control and LMF compensation and individual control, is the individual LLCC and the BAT option.

The above figures however show that each individual option generates savings (except option 1 which is a worst case simulation using halophosphate). Because this is so, the simultaneous implementation of all options that can be combined, depending on the typical office situation in which to use and install the luminaires, should be endeavoured. Further in this study, and mainly in chapter 8 on EU25 calculations; the following combinations are evaluated:

- **BAT:** use only triphosphor lamps as in the base case situation + option 6 (improved LMF at 4 years) + option 8 (UFr BAT median) + option 11 (daylight control and manual dimming). Note that individual option 9 (daylight control + manual dimming + LMF compensation) is better than individual option 11 (without LMF compensation) but since the combination is with option 6, this LMF compensation is not required anymore.
- **Minimum BAT:** this is a minimum BAT combination without dimming features because in some office situations this might not be applicable (e.g. no daylight zone, occupancy independent lighting, etc...). In this case the following options are combined: option 4 (BAT values for electronic non-dimmable ballasts) + option 6 + option 8.

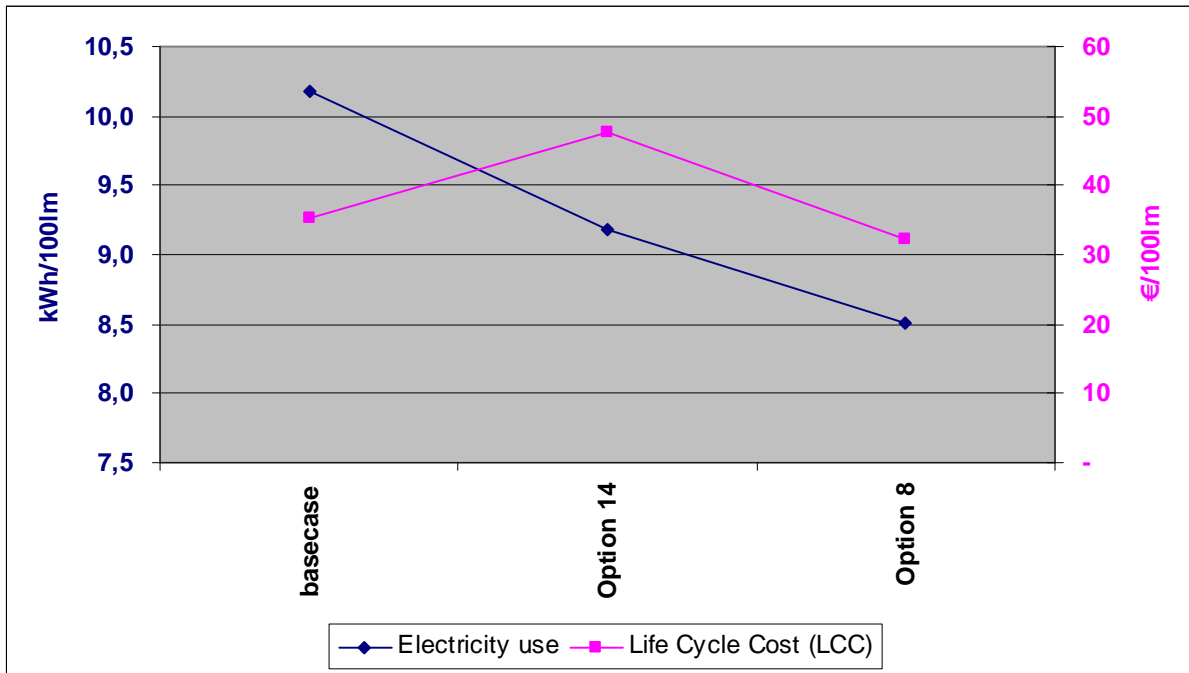

Figure 54: Ranking of options for type A2 luminaires in cellular offices

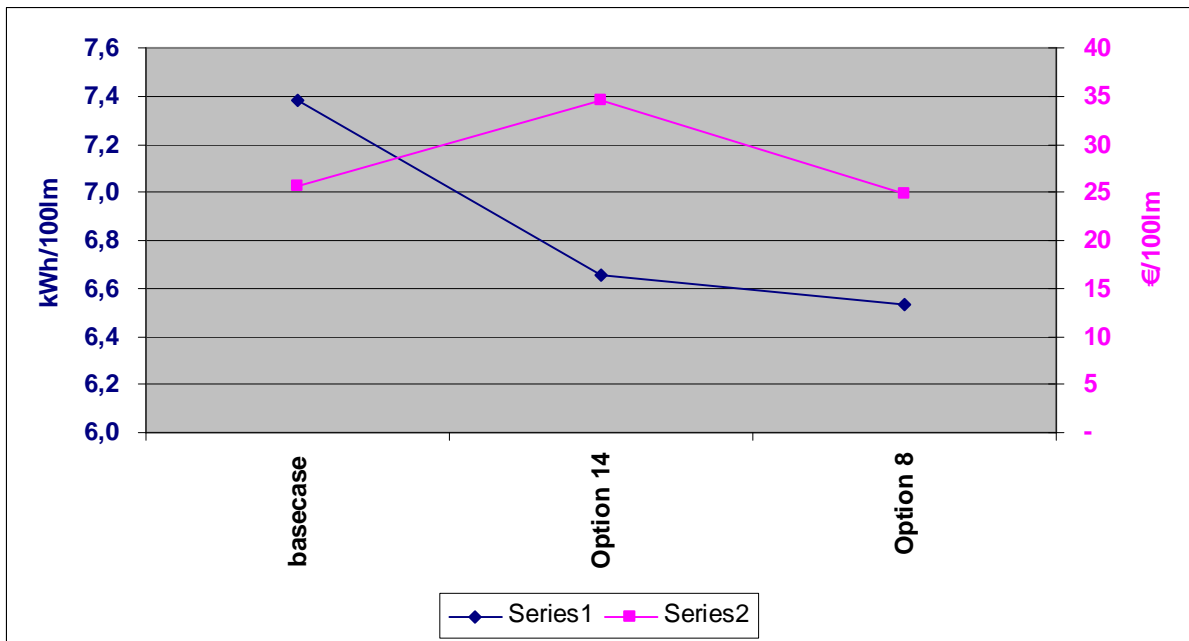

Figure 55: Ranking of options for type A2 luminaires in open plan offices

Particular options evaluated for A2-types of luminaires are option 8 (setting minimum UFr level) and option 14 (use of T5 High Efficiency). Both options generate savings in terms of electricity use per functional lumen output. Option 8 generates almost no life cycle cost savings per functional lumen output and is due to the assumed increase in purchase price (50€ increase compared to base case luminaires). LCC per functional lumen output of option 14 is even

higher compared to the base cases. This is because under this option a 54W T5 is replaced with a 28 W High Efficiency T5 lamp. Though the efficiency of the last lamp is higher (lm/W), the total lumen output of the luminaire decreases so that more luminaires are required to lit the same amount of office surface at a level of 500 lx which explains the LCC increase. The LCC would go down (below base case level) when a luminaire with two 28W HE T5 substitutes the base case luminaire with one 54W T5 (shown in the following figure).

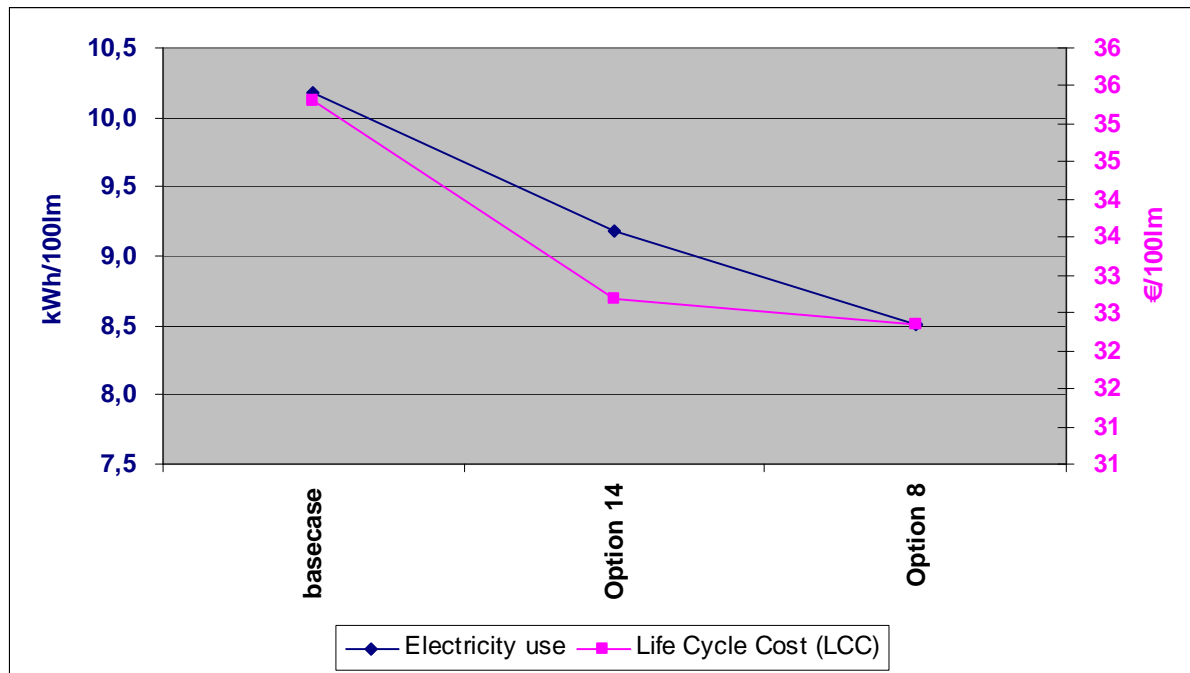

Figure 56: Ranking of options for type A2 luminaires in cellular offices (2 highly efficient T5 lamps per luminaire for option 14)

7.3 Long-term targets (BNAT) and system analysis

Scope:

- Discussion of long-term technical potential on the basis of outcomes of applied and fundamental research, but still in the context of the present product archetype;
- Discussion of long-term potential on the basis of changes of the total system to which the present archetype product belongs.

7.3.1 Market introduction of BNAT new LED luminaires

LED and LED luminaires are described in chapter 6 as BNAT. They could contribute to further improvement if there performance increases and the price drops, the current available product data (2006-7) is not competitive for this office lighting application (see chapter 6).

7.3.2 Market introduction of BNAT new OLED luminaires

OLED and OLED luminaires are described in chapter 6 as BNAT. They could contribute to further improvement if their performance increases and the price drops, the current available product data (2006-7) is not competitive for this office lighting application (see chapter 6).

7.3.3 System related improvement potential

The following system related changes can also contribute to a reduced environmental impact:

- Increase the reflectance of walls and ceilings in small offices (< 30 m²).
- Building designs with increased use of daylight.
- Installation of building management systems, especially zoning that enables to switch off selected areas and presence detection. Building management systems can also increase awareness for lighting energy consumption in buildings.
- Increasing the awareness of the energy consumption.

8 SCENARIO- POLICY- IMPACT- AND SENSITIVITY ANALYSIS

Scope: This chapter summarizes and totals the outcomes of all previous tasks. It looks at suitable policy means to achieve the potential e.g. implementing LLCC as a minimum and BAT as a promotional target, using legislative or voluntary agreements, labelling and promotion. It draws up scenarios 1990 – 2020 quantifying the improvements that can be achieved vs. a Business-as-Usual. It makes an estimate of the impact on consumers and industry as explicitly described in Appendix 2 of the Directive.

Finally, in a sensitivity analysis of the main parameters, it studies the robustness of the outcome.

8.1 Policy- and scenario analysis

8.1.1 Eco-design requirements

In this chapter generic and specific product related eco-design requirements are described that can be used as suitable policy means to achieve BAT or LLCC scenario targets.

8.1.1.1 *Generic Eco-design requirements on the supply of information*

Optimal design and use of office lighting and as a matter of fact all other functional indoor lighting systems starts with adequate information on existing products and parts. Therefore it is proposed that the manufacturers provide the following 'most relevant' eco-design parameters and follow the proposals for appropriate means for communication of these parameters. The provision of these 'most relevant' parameters can satisfy article 15. 4 (f) to reduce unnecessary administrative work and should allow to verify compliance with proposed specific implementing measures. In many cases it is impossible to discriminate luminaires, lamps and ballasts at the 'putting on the market' stage that are intended for 'office' lighting from other indoor lighting applications, see impact discussion in section 8.2.1. It is therefore recommended to define a broad scope for luminaires within the generic and specific eco-design requirements.

The following possibilities exist for defining the scope of affected luminaires:

1. All 'indoor' luminaires that include 'linear fluorescent lamps' and/or 'compact fluorescent lamps with non integrated ballast' and initial lamp lumen above 1000, wherein 'indoor means luminaires with ingress protection degree IP2X.

The minimum lumen output allows to exclude special luminaires for emergency lighting and wall mounted or other applications with low lumen demand and hence low energy consumption.

2. Create a label to discriminate office luminaires that include 'linear fluorescent lamps' and/or 'compact fluorescent lamps with non integrated ballast' also when these luminaires include other lamp types. Please note that this system needs also to be recommended for other functional indoor lighting luminaires that are based on other lamp technology (e.g. LED). It can be considered to implement the first and/or the second scope option.

Luminaire manufacturers shall supply the following data and instructions:

- The CEN flux code as defined in EN 13032-2, available for the customer. Alternatively the manufacturer can supply the complete CEN photometric data file (in EN 13032-2). The complete photometric data file is required in case that the manufacturer wants to rely on the 'detailed optical performance evaluation' and on the alternative, more refined luminaire classification and labelling system if it becomes available in time (e.g. from CELMA).
- Ballast efficiency, see related proposal for ballasts for luminaires. The parameter η_{ballast} is defined in chapter 1 and can be derived from European standards.
- Information on the recommended lamp and its efficacy and ballast and its efficiency.
- Luminaire Efficacy Rating corrected:

$$\text{LERc} = \text{LOR} \times (\text{DFF} + 0.5\text{UFF}) \times \eta_{\text{ballast}} \times \eta_{\text{lamp}}$$

with LOR in luminaire standard working conditions (ambient temperature 25°) and η_{lamp} at 25°C. This LERc parameter can provide clear information to consumers that enable comparison in normal working conditions independent of LFL lamp type (T5 or T8). The use of LERc was recommended because the single use of LOR does not allow to compare the efficiency of T5 with T8 fluorescent lamp luminaires as explained in chapters 1 and 4. When using T5 lamps, the LOR includes an efficiency increase due to the increased lamp operation temperature and this is not the case for T8 lamps. This is also reflected in lamp efficacy in standard conditions (25°C) where the efficacy of T5 is lower compared to T8 fluorescent lamps (see chapter 4). Please note that η_{lamp} (lm/W) at 25°C is lower for T5 compared to T8 LFL lamps because T5 lamps are designed for higher operation temperatures. Please note also that LOR (N5), DFF (N4) and UFF (N9) are included in the CEN flux code. In case of multiwatt ballasts (see chapter 2) multiple LERc values should be included for all the recommended lamp types. The upward light flux fraction (UFF) is only accounted for 50 % in order to model indirect light as accurate as possible for functional lighting requirements, this approach is also used as approximation for the UF (Utilisation Factor) in the UK Building Regulations Part L2 (BNCL (2006)) and the Belgian building directive implementation (EPB Bijlage 2 (2005)). Evaluations in chapter 4 did confirm the relevance and accuracy of this simplified UF approach (Figure 33, Figure 34, Figure 36, Figure 37). Alternatively LER (= LOR x η_{ballast} x η_{lamp}) could be used (e.g. as in NEMA LE 5-2001), but in this approach indirect lighting is weighted as much as direct lighting and the approximation of UF is therefore less accurate. In standards for functional indoor lighting (e.g. EN 12464-1) UF is very important because it is directly related to the required illuminance level (e.g. 500 lux) (see also chapter 4).

- A luminaire light distribution class indicator as suggested in *DIN 5040-2*.
The motivation for this proposal is:
 - In theory this information is included in the nine numbers of the CEN flux code, however this could be too difficult to understand by a large group of users. Alternatively there are the existing DIN 5040 'LVK classes' (more info see chapter 1) according to light distribution, but they are complicated to calculate and would create too much administrative work. Therefore it is recommended to create a similar but more simplified approach directly related to the CEN flux code.
 - The CEN Flux code is directly product related (see chapter 4).
 - This allows to put requirements and performance data or labels on luminaires according to light distribution classes comparable to SN 520 380/4(2006).
 - It relies only on the nine numbers of the CEN flux code and a complete photometric file is not needed as a minimum requirement for putting a luminaire on the market. Please also look at recommendation in 8.1.6 for the development of a complementary fast and easy market surveillance technique.
- Please note that for office lighting the most common light distribution classes are 'D-M' for category A1 luminaires in this study or 'DI-M' for category A1. Narrow beam luminaires (e.g. D-N) are commonly applied in buildings with high ceilings and wide beam luminaires (e.g. DI-W) can be used in rooms with low glare requirements. Please note that luminaires with low glare in a standard open office environment do not emit light in near to horizontal angles and will belong therefore to the 'D-M' or 'DI-M' light distribution category.

Explanation of the CEN flux code (source EN 13032-2):

The CEN (or CIE) flux code is representing the optical characteristics of the luminaire and consists of 9 whole numbers (see Figure 57) separated by spaces defined as:

FCL1/FCL4, FCL2/FCL4, FCL3/FCL4, DFF, LOR, FCU1/FCU4, FCU2/FCU4, FCU3/FCU4, UFF

equal to respectively,

N1, N2, N3, N4, N5, N6, N7, N8, N9.

Where,

UFF is upward flux fraction ($= ULOR/LOR = 1 - DFF$)

DFF is downward flux fraction ($= DLOR/LOR$)

LOR is light output ratio

FCL1-4 are accumulated luminous fluxes in lower hemisphere for the four zones from 0° to 41.4° (FCL1), 60° (FCL2), 75.5° (FCL3) and 90° (FCL4).

FCU1-4 are accumulated luminous fluxes in upper hemisphere for the four zones from 180° to 138.6° (FCU1), 120° (FCU2), 104.5° (FCU3) and 90° (FCU4).

Remarks:

- For luminaires with downward flux only the CEN flux code in abbreviated form consists of only the first 5 whole numbers (N1, N2, N3, N4, N5):
- Please note that LOR is for lamps at optimum working temperature.

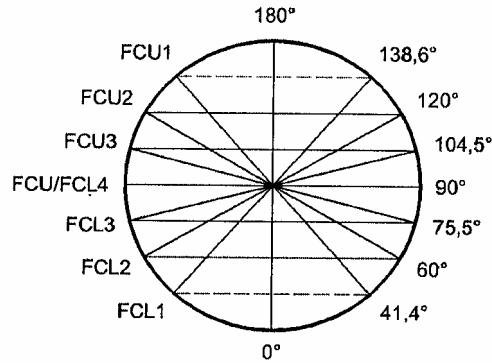

Figure 57: Downward and upward zones for the calculation of accumulated luminous fluxes

The proposal for light distribution classes is included in Table 92.

Table 92: Proposal for new lighting distribution classes

class code indicator	LVK class example	name	beam	CEN flux code								
				N1	N2	N3	N4	N5	N6	N7	N8	N9
D-W	A10-A32	direct lighting	wide	NA	≤0.9	>0.9	>0.9	NA	NA	NA	NA	NA
D-M	A40-A44	direct lighting	medium	≤0.9	>0.9	NA	>0.9	NA	NA	NA	NA	NA
D-N	A50-A80	direct lighting	narrow	>0.9	NA	NA	>0.9	NA	NA	NA	NA	NA
DI-W	B21-B22	direct with indirect lighting	wide	NA	≤0.9	>0.9	≥0.5 <0.9	NA	NA	NA	NA	NA
DI-M	B31-B33	direct with indirect lighting	medium	≤0.9	>0.9	NA	≥0.5 <0.9	NA	NA	NA	NA	NA
DI-N	B41-B63	direct with indirect lighting	narrow	>0.9	NA	NA	≥0.5 <0.9	NA	NA	NA	NA	NA
ID-W	C11-C33	indirect with direct lighting	wide	NA	≤0.9	>0.9	≥0.1 <0.5	NA	NA	NA	NA	NA
ID-M	C42-C63	indirect with direct lighting	medium	≤0.9	>0.9	NA	≥0.1 <0.5	NA	NA	NA	NA	NA
I-M	D11-D63	indirect lighting	medium	NA	NA	NA	≤0.1	NA	NA	>0.9	NA	NA
I-W	E02-E73	indirect lighting	wide	NA	NA	NA	≤0.1	NA	NA	≤0.9	>0.9	NA

- Please note that this requested generic information does not necessarily need to be attached to the product or supplied on a paper document, much internet based systems can be thought off that refer to a product number.
- It is recommended to connect a label related to the LERc value and luminaire light distribution class in order to give the consumer a rough idea about its

relative performance for indoor lighting with LFL lamps. This information is primary intended to implement the product information requirement for 'putting on the market' under the eco-design directive. As mentioned in section 3.1 various actors (users, service providers, ..) are involved during the putting into service, therefore it could be necessary to display this information (e.g. as part of the energy labelling directive). This data can be verified in the framework of market surveillance. Please note that this label does not necessary relieve the manufacturers from providing the exact LERc value to the user. It is also proposed for reasons mentioned in section 8.1.1.2 to discriminate LERc levels for luminaires with total lamp luminous flux ($\Phi@25\text{ }^{\circ}\text{C}$ below and above 2000 lm.

Proposal for reference LERc values and labels are included in Table 93 and Table 94.

Table 93 Proposal for LERc reference values related to lighting distribution classes for luminaires with total lamp luminous flux ($\Phi@25\text{ }^{\circ}\text{C} \geq 2000\text{ lm}$)

class code	name	beam	LERc					
			F	E	D	C	B	A
D-W	direct lighting	wide	48	60	64	68	71	75
D-M	direct lighting	medium	44	55	59	63	66	70
D-N	direct lighting	narrow	40	50	54	58	61	65
DI-W	direct with indirect lighting.	wide	44	55	58	60	63	65
DI-M	direct with indirect lighting	medium	40	50	54	58	61	65
DI-N	direct with indirect lighting	narrow	36	45	49	53	56	60
ID-W	indirect with direct lighting.	wide	28	35	39	43	46	50
ID-M	indirect with direct lighting	medium	24	30	34	38	41	45
I-M	indirect lighting	medium	21	26	30	33	37	40
I-W	indirect lighting	wide	24	30	33	35	38	40

Table 94: Proposal for LERc reference values related to lighting distribution classes for luminaires with total lamp luminous flux ($\Phi@25\text{ }^{\circ}\text{C} < 2000\text{ lm}$)

class code	name	beam	LERc					
			F	E	D	C	B	A
D-W	direct lighting	wide	40	50	54	57	60	63
D-M	direct lighting	medium	37	46	49	53	56	59
D-N	direct lighting	narrow	34	42	45	48	51	55
DI-W	direct with indirect lighting.	wide	37	46	48	50	53	55
DI-M	direct with indirect lighting	medium	34	42	45	48	51	55
DI-N	direct with indirect lighting	narrow	30	38	41	44	47	50
ID-W	indirect with direct lighting.	wide	24	29	33	36	39	42
ID-M	indirect with direct lighting	medium	20	25	28	32	35	38
I-M	indirect lighting	medium	17	22	25	28	31	34
I-W	indirect lighting	wide	20	25	27	29	32	34

Note on the source of this data:

These values are obtained based on the following sources and assumptions:
 Class code 'D-M' and 'DI-M' are directly related to the luminaires assessed for office lighting in this study in chapter 4. The typical LERc and LER values can be found in Table 66 and Table 68.

The minimum values for level 'E' in Table 93 is according to the minimum level for implementing improvement option 8 as explained in section 7.1.1.8. For class code 'D-M' this results in $0.3 \times \text{LER}_{\text{cmin}} + 0.7 \times \text{LER}_{\text{cmax}} = 54$ and for class code 'DI-M' in $0.3 \times \text{LER}_{\text{cmin}} + 0.7 \times \text{LER}_{\text{cmax}} = 53$. Please also note that the value for class code 'D-M' (54) is very close to the minimum values (55) specified in standard SN 520 380/4(2006) in Table 7. This confirms that Table 7 values are very ambitious to implement and are directly related to the BAT scenario described later in this chapter. In order to allow a transition period a level 'F' was introduced that is at $0.8 \times \text{level 'E'}$ because many products found on the market nowadays are within this category 'F'. Other class code starting with 'D' and 'DI' are proportionally derived from Table 7 and Table 8. The class code 'I' was chosen at about 50 % of from Table 7 and Table 8 due to the difference between LER and LERc. Class code 'ID' was derated in-between 'I' and 'DI'. For luminaires with lower lumen output the effect of the lower efficacy of low power fluorescent lamps and low power ballasts was taken into account by a general correction factor $(\eta_{\text{lamp}}(\text{CFL13W}) / \eta_{\text{lamp}}(\text{CF36W}) \times \eta_{\text{ballast}}(\text{13W}) / \eta_{\text{ballast}}(\text{CFL36W})) = 0.85$, data in Table 62 and Table 63), LERc result and labels in Table 94. Please note that performant luminaires with low glare (UGR) in office room conditions were assessed in chapter 4 and these luminaires were able to satisfy A-label requirements.

- Warning: if no dimming ballast or light output control is incorporated.
- Recommended environmental temperature data for luminaires operated with T5 lamps should be available with clear description of test circumstances.
- For all luminaires excluding the so-called 'bare batten' or 'strip' luminaires that belong to the proposed lighting distribution class DI-W, applicable LMF value data should be provided with cleaning instructions if needed up to 4 years. If this data is not available it should be indicated that the luminaires are not suitable for application where 'maintained illuminance is specified, in accordance to EN 12464-1(2004). LMF specification should be done according to CIE 97 (2007) on 'The maintenance of indoor lighting systems' (see Table 95).

Table 95: Typical model for LMF value specification according to CIE 97

LMF Environment	cleaning intervals [year]						
	1,0	1,5	2,0	2,5	3,0	3,5	4,0
Very Clean							
Clean							
Normal (optional)							
Dirty (optional)							

- Lamp and ballast replacement instructions.
- Disassembly instructions.
- Compliance with WEEE and RoHS directive.

- The above presented luminaire classification system is new for the market. The evaluation of its effectiveness is therefore recommended short after its introduction (e.g. 18 months).
- If before the consultation forum a more refined luminaire classification and labelling system becomes available (e.g. from CELMA), this second system could be examined to complete to the above presented system. It is suggested that manufacturers could also rely on a 'detailed optical performance evaluation' that should be based on this second system for satisfying minimum product criteria. If this second system becomes available it is recommended to evaluate it together with above system short after its introduction (e.g. 18 months). The complete photometric data file is required for this system.

For all LFL en CFL-ni lamp ballasts in order to promote new improved ballasts with BAT efficiency levels (option 4):

- It is recommended to make compulsory ballast efficiency labels to implement the product information requirement for the 'putting on the market' of LFL or CFL-ni ballasts under the eco-design directive. As mentioned in section 3.1 various actors (luminaire manufacturers, service providers, users, ..) are involved during the putting into service of ballasts, therefore it could be necessary to display this information to all actors in the putting into service chain, e.g. as part of the energy labelling directive. Please note that these ballasts are put on the market as replacement part or integrated in a new luminaire.
- Existing CELMA ballast labels can be considered as a reference. It is recommended to update the minimum levels of the A categories (A1, A2, A3). The coexistence of level A1 (dimming ballast) that corresponds at full power with level A3 (non dimming) can be confusing for consumers. Therefore it is recommended to use A1, A2, .. for non dimming ballasts and AD1, AD2, AD3 for dimming ballasts in future. Please note that in practice category A3 is seldom used, only when for design purposes very compact ballast are desired (see 6.1.6). Because there is an increasing amount of lamp types available on the market it is also recommended to connect the related efficiency requirements directly to the total LFL lamp power instead of lamp type.

For all LFL and CFL-ni lamps:

- Lamp efficacy at 100 h, and LLMF at 5000h, 10000h, 15000h and 20000h. These data are essential to determine the maintained lighting levels according to standard EN 12464-1.
- LSF data at 5000h, 10000h, 15000h and 20000h.. Combination of LSF, LLMF and LMF data are necessary to optimize the maintenance period in order to achieve the minimum operating costs.
- This information is recommended to implement the eco-design directive. As mentioned in section 3.1 various actors (luminaire manufacturers, service providers, users, ..) are involved during the putting into service of these lamps, therefore it could be necessary to display this information to all actors in the putting into service chain, e.g. as part of the energy labelling directive.

Proposed timing for this measures:

ASAP.

The newly presented luminaire classification should be evaluated for its effectiveness short after its introduction (e.g. 18 months).

8.1.1.2 Specific ecodesign requirement required for increasing fluorescent lamp efficacy (option 14)

The proposed ecodesign requirement is to set minimum efficacy (η_{lamp}) and lumen maintenance (LLMF) targets for hot cathode fluorescent lamps, see Table 96, Table 97, Table 98, Table 99. These values will exclude halophosphate lamps from the market that are inefficient and contain more mercury.

As requested in standards EN 60081 and EN 60901, lamp flux is measured after 100 hours of burning; lamp efficacy is based on that value.

Coloured lamps and lamps for special applications i.e. lamps of which the chromaticity coordinates are located outside the tolerance zones for white lamps as defined in standard EN 60081, Annex D, fig. D.1, D.2, D.3, D.4, D.5 and D.6, are exempted from the requirements below, because they are not suited for general lighting applications.

Lamps with more than 90 % light output in a solid angle of 2π should be exempted (e.g. reflector lamps). An approach for these lamps will be investigated in the future EuP preparatory study on domestic lighting.

The minimum lamp efficacy requirements are listed at 25°C, as defined by standard EN 60081. For T5-lamps, this temperature is not the optimum working temperature of 35°C. In an appropriate luminaire, this optimum working temperature is realized; efficacies at 25°C as well as at optimum temperature are listed in Table 97 and Table 98.

There are two types of T5-lamps: lamps with high efficiency (HE) and lamps with high output (HO). Because the lamps with high output have a considerable lower efficacy, it is recommendable to phase out those lamps. The phasing out period could be set at 15 years, but the phasing out of luminaires for T5 HO should be set ASAP. This can be done by requiring that the lamp efficacy related to the lamp power should be equivalent to HE T5-lamps in new luminaires.

Linear fluorescent lamps (LFL) with other diameters should match at least the values in Table 96 or Table 97. In case that the lamp power is different, the efficacy should be interpolated between two adjacent power levels. Lamps with a diameter less than 0,8 T5 (e.g. T2) should be exempted, because they are less efficient and are mainly used in displays and signs. Lamps with an external ignition strip should also be exempted, this are mainly T12 lamps that are used in cold environmental temperatures. This requirement will also phase out inefficient T12 lamps used for general illumination.

The efficacy of lamps with a colour temperature $T_c \geq 5000K$ is lower (see manufacturers catalogue data). It was not reported that these lamps are often used in offices. It is proposed to include these lamps as indicated in Table 96, Table 97 and Table 98.

It is obvious that all future developments that result in new lamp wattages or new lamp types should aim to obtain at least the minimum efficacy values of the best, current lamps; this means that the minimum lamp efficacy should be equal to or even better than the values pointed out in Table 97 (efficacies @ optimum temperature) for the same lamp power or its interpolated value.

It is important to remark that LFL and CFL-ni are also used in many other applications; the impact will be explained later in this chapter (section 8.2). Because the application of the lamp is unknown during the putting on the market, it is recommended to consider implementing measures affecting all LFL and CFL-ni lamps (i.e. an horizontal measure). Therefore a technology based approach is recommended. The next paragraphs are containing data based on state of art lamp performance catalogue data that can be used for this approach.

It is recommended to impose Table 99 for CFL lamps ,this table was provided by industry. The proposed CFL efficacy values are in conformity with the 'EcoProfile 070516 FL' and 'EcoProfile 061106 CFL' from ELC. For lamp wattages that are not given in the tables, a linear interpolation between the adjacent values is recommended.

A derating factor (x 0,8) should be applied for lamps with a high colour rendering index ($R_a \geq 90$), because these lamp have a lower lamp efficacy and are only used in places where high colour rendering is needed (e.g. for the inspection of colour printings, ..). These value is based on catalogue data.

When lamps have an external protective sleeve (e.g. as used in the food processing industry to prevent contamination with mercury), a derating factor is suggested (e.g. 0,95) but this value should be provided by industry.

Table 96: MEPs proposal for LFL type T8

LFL T8 Ra<90	Minimum Lamp Efficacy @ optimum temperature (25°C)	
	Magnetic ballast (50Hz)	Electronic Ballast (HF)
Lamp power (magn. ballast) [W]		
15	64	
18	75	82
30	80	
36	93	100
58	89	100

For lamps with $T_c \geq 5000K$, these values have to be decreased by multiplying them with 0,92
 For lamps with $R_a \geq 90$, these values have to be decreased by multiplying them with 0,8.

Table 97: MEPs proposal for LFL type T5, High Efficiency

LFL T5 High Efficiency Ra<90	Minimum Lamp Efficacy @ optimum temperature (35°C)	Minimum Lamp Efficacy @ 25°C
Lamp power [W]		
14	95	86
21	99	90
28	102	93
35	103	94

For lamps with **Tc ≥ 5000K**, these values have to be decreased by multiplying them with 0,92.
 For lamps with **Ra≥90**, these values have to be decreased by multiplying them with 0,8.

Table 98: MEPs proposal for LFL type T5, High Output







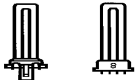

LFL T5 High Output Ra<90	Minimum Lamp Efficacy @ optimum temperature (35°C)	Minimum Lamp Efficacy @ 25°C
Lamp power [W]		
24	80	73
39	88	79
49	97	88
54	90	82
80	85	77

For lamps with **Tc ≥ 5000K**, these values have to be decreased by multiplying them with 0,92.
 For lamps with **Ra≥90**, these values have to be decreased by multiplying them with 0,8.

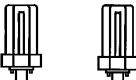
As mentioned before, these lamps have to be phased out.

Table 99: MEPs proposal for CFL-ni @ optimum temperature (25°C)

Based on 100h Minimum Value IEC 60901 (90% of 100h initial)

		Small single parallel tube, lamp cap G23 (2 pin) or 2G7 (4pin)							
Type		5	7	9	11	Cap G23 (2pin) or 2G7 (4pin) Small single parallel tube			
Wattage		5	7	9	11				
nominal light output (lm) for Tc < 5000K (e.g. 827, 830, 835, 840)		250	400	600	900				
nominal light output (lm) for Tc ≥ 5000K (e.g. 850, 865)		225	360	540	810				
minimum efficacy (lm/W) for Tc < 5000K (e.g. 827, 830, 835, 840)		45	51	60	74				
minimum efficacy (lm/W) for Tc ≥ 5000K (e.g. 850, 865)		41	46	54	66				
		Double parallel tubes, lamp cap G24d (2 pin) or G24q (4 pin)							
Type		10	13	18	26	Cap G24d (2pin) or G24q (4pin) Double parallel tubes			
Wattage		10	13	18	26				
nominal light output (lm) for Tc < 5000K (e.g. 827, 830, 835, 840)		600	900	1200	1710				
nominal light output (lm) for Tc ≥ 5000K (e.g. 850, 865)		540	810	1080	1540				
minimum efficacy (lm/W) for Tc < 5000K (e.g. 827, 830, 835, 840)		54	62	60	59				
minimum efficacy (lm/W) for Tc ≥ 5000K (e.g. 850, 865)		49	56	54	53				
		Triple parallel tubes, lamp cap GX24d (2 pin) or GX24q (4 pin)							
Type		13	18	26	32	42	57	70	Cap GX24d (2pin) or GX24q (4pin) Triple parallel tubes
Wattage		13	18	26	32	42	57	70	
nominal light output (lm) for Tc < 5000K (e.g. 827, 830, 835, 840)		900	1200	1710	2400	3200	4300	5200	
nominal light output (lm) for Tc ≥ 5000K (e.g. 850, 865)		810	1080	1540	2160	2880	3870	4680	
minimum efficacy (lm/W) for Tc < 5000K (e.g. 827, 830, 835, 840)		62	60	59	68	69	68	67	
minimum efficacy (lm/W) for Tc ≥ 5000K (e.g. 850, 865)		56	54	53	61	62	61	60	
		Four parallel tubes, lamp cap GX24q (4 pin)							
Type		57	70			Cap GX24q (4pin) Four parallel tubes			
Wattage		57	70						
nominal light output (lm) for Tc < 5000K (e.g. 827, 830, 835, 840)		4300	5200						
nominal light output (lm) for Tc ≥ 5000K (e.g. 850, 865)		3870	4680						
minimum efficacy (lm/W) for Tc < 5000K (e.g. 827, 830, 835, 840)		68	67						
minimum efficacy (lm/W) for Tc ≥ 5000K (e.g. 850, 865)		61	60						
		Long single parallel tube, lamp cap 2G11 (4 pin)							
Type		18	24	36	40	55	80	Cap 2G11 (4pin) Long single parallel tube	
Wattage		18	24	36	40	55	80		
nominal light output (lm) for Tc < 5000K (e.g. 827, 830, 835, 840)		1200	1800	2900	3300	4500	6000		
nominal light output (lm) for Tc ≥ 5000K (e.g. 850, 865)		1080	1620	2610	2970	4050	5400		
minimum efficacy (lm/W) for Tc < 5000K (e.g. 827, 830, 835, 840)		60	68	73	74	74	68		
minimum efficacy (lm/W) for Tc ≥ 5000K (e.g. 850, 865)		54	61	65	67	66	61		
		4 legs in one plane, lamp cap 2G10 (4 pin)							
Type		18	24	36			Cap 2G10 (4pin) 4 legs in one plane		
Wattage		18	24	36					
nominal light output (lm) for Tc < 5000K (e.g. 827, 830, 835, 840)		1100	1700	2800					
nominal light output (lm) for Tc ≥ 5000K (e.g. 850, 865)		990	1540	2520					
minimum efficacy (lm/W) for Tc < 5000K (e.g. 827, 830, 835, 840)		55	64	70					
minimum efficacy (lm/W) for Tc ≥ 5000K (e.g. 850, 865)		50	58	63					
		Single flat plane tube, lamp cap GR8 (2 pin), GR10q (4 pin) or GRY10q3 (4 pin)							
Type		10	16	21	28	38	55	Cap GR8 (2 pin), GR10q (4pin) or GRY10q3 (4 pin) Single flat bent tube	
Wattage		10	16	21	28	38	55		
nominal light output (lm) for Tc < 5000K (e.g. 827, 830, 835, 840)		650	1050	1350	2050	2700	3200		
nominal light output (lm) for Tc ≥ 5000K (e.g. 850, 865)		585	945	1215	1845	2430	2880		
minimum efficacy (lm/W) for Tc < 5000K (e.g. 827, 830, 835, 840)		59	59	58	66	64	52		
minimum efficacy (lm/W) for Tc ≥ 5000K (e.g. 850, 865)		53	53	52	59	58	47		
		Four or three parallel T5 tubes, lamp cap 2G8 (4 pin)							
Type		60	82	85	120	Cap 2G8 (4pin) Four or three parallel T5 tubes			
Wattage		60	82	85	120				
nominal light output (lm) for Tc < 5000K (e.g. 827, 830, 835, 840)		4000	6150	6000	9000				
nominal light output (lm) for Tc ≥ 5000K (e.g. 850, 865)		3600	5535	5400	8100				
minimum efficacy (lm/W) for Tc < 5000K (e.g. 827, 830, 835, 840)		60	68	64	68				
minimum efficacy (lm/W) for Tc ≥ 5000K (e.g. 850, 865)		54	61	57	61				

Source: ELC, EcoProfile 061106 CFL.

Table 100: Minimum LLMF proposal for fluorescent lamps.

Burning hours	5000	10000	15000	20000
Lamp types				
Linear Fluorescent lamps (HF)	0.92	0.90	0.90	0.90
Compact Fluorescent lamps, non integrated (HF)	0.91	0.87	0.85	

Proposed timing:

Phasing out T5 HO lamps in 15 years.

Other proposals ASAP because these measures realize a quick energy saving without special investments.

8.1.1.3 Specific ecodesign requirements required for reducing lamp mercury (option 1)

It is recommended to set limits on the lamp mercury (Hg) content. According to information, provided by industry, it is not possible to produce halophosphate lamps with less than 10mg Hg. As a consequence, halophosphate fluorescent lamps could be excluded from the market by repealing in the RoHS-directive the exemption that was made on the mercury content of 10mg for certain fluorescent lamps. The maximum mercury content should be limited at an absolute maximum of 8mg instead of 10mg.

Also imposing that the lamp lumen maintenance factor (LLMF) should meet at least the values listed in Table 100 would exclude halophosphate lamps from the market.

Proposed timing for this measures:

ASAP.

8.1.1.4 Specific ecodesign requirements required for option 2, 3 and 4 increasing the ballast efficiency up to minimum level EEI (CELMA) = B1(option 2), A2 (option 3) and A1 (option 9,10, 11, 12)

This measure could be implemented by updating the minimum level in the existing directive 2000/55/EC on energy efficiency requirements for ballasts for fluorescent lighting.

Please note also that these ballasts are put on the market as replacement part or integrated in a new luminaire and that LFL and CFL-ni ballasts are also used in many other non office task area applications, the impact will be explained later in section 8.2. Because the application of the ballasts is unknown during the putting on the market it is recommended to consider an implementing measure affecting all LFL and CFL-ni lamp ballasts.

Because this study focuses on professional functional lighting equipment it is recommended to reduce the impact on existing very low cost luminaires (about 10 euro) with fluorescent lamps. These low cost luminaires are often installed in technical rooms (e.g. cellar) of buildings where they are not frequently used or in domestic applications with very cost sensitive consumers that might shift to other less efficient solutions.

Therefore it is recommended to couple these new increased minimum requirements to the type of luminaire, the proposal is as follows:

1. Keep the actual B2 level (actual MEPS) in 'bare batten' or 'strip luminaires' (IP2X) belonging to the proposed lighting distribution class 'DI-W' (Table 92).
2. Increase to B1 level in plastic luminaires with ingress protection grade IP4X or higher (e.g. water proof luminaires). (This is also functionally beneficial because these luminaires are in most cases manufactured of plastic and don't allow high temperatures).
3. Increase to level A2 for all other LFL and LFL-ni luminaires (IP2X) with total maximum lamp rated lumen output below 2000 lumen.

4. CELMA level EEI = A3 ballasts are intrinsic more compact compared to A2 level ballasts (see 6.1.6). They can still be useful in low power very compact luminaires that are for example used in domestic lighting. Therefore it is recommend to allow level A3 for ballasts intended for lamps with total rated lumen output below 2000 lumen.

5. Increase to level A1 for all other LFL and LFL-ni luminaires (IP2X) with total maximum lamp rated lumen output above 2000 lumen after a transition period (2012) in which level A2 is admitted. This transition period is required because not all manufacturers of electronic ballasts have dimmable versions and, as explained in chapter 6, important related patents expire in 2009. Manufacturers not having yet this technology should have time to develop A1 ballasts. As indicated in chapter 3 and 6 dimming is a basic requisite for many energy saving techniques, therefore it is useful to consider it at product level for the most energy consuming products despite its relationship to the putting into service. A dimming lighting luminaire can anticipate over its long typical service life to a change in room illumination needs, room surface reflection characteristics (Figure 39, Figure 40, Figure 41, Figure 42) and product performance decrease or increase (e.g. when using a more efficient lamp). Please note that at full power the energy loss of A1 (dimming ballast) is equal to level A3 (non dimming), therefore revision of the CELMA labels is recommended and an equal efficiency should be required for level A1 compared to level A2.

Proposed timing:

ASAP but respecting the recommended transition period.

8.1.1.5 Specific ecodesign requirements required for option 5 maximum stand by losses for ballasts

More information on the subject can be found in the EuP preparatory study on standby and off mode losses. This requirement is particularly important for luminaires that incorporate control interfaces. It is recommended to follow the limits that are formulated in lot 6 (version of 18/6/2007, see table 8-4):

- Tier 2 from 2012: 0.75W in off-mode and 1W in standby.
- Tier 1 from 2010 up to 2011: 1 W in off-mode and 3 W in standby

Please note that 1 W standby loss was already used in the calculations in this study (Table 65).

Proposed timing:

- Tier 2 from 2012: 0.75W limit in off-mode and 1W in standby.
- Tier 1 from 2010 up to 2011: 1 W limit in off-mode and 3 W in standby

Please note that it is possible to implement this requirement in an horizontal measure that affect all defined products.

8.1.1.6 Specific ecodesign requirements required for option 6 from chapter 7: Increasing luminaire maintenance factor (LMF)

This can be done by requiring a $LMF > 0.95$ in normal office pollution degrees (CIE 97) with a cleaning cycle of 4 years.

If these conditions cannot be met, the manufacturer should warn on all published documentation that these luminaires are not suitable for professional applications where

maintained illuminance is required. In such a case complementary measures would be required to exclude the putting into service of these luminaires for professional applications where maintained illuminance is required. This requirement can make the related generic implementing measure on LMF data obsolete.

Proposed timing:

ASAP

8.1.1.7 Specific ecodesign requirements required for option 8 from chapter 7: 'Increasing optic efficiency by increasing the luminaire efficacy (LERc)

This can be implemented by having minimum 'E' label LERc values (see Table 93 and Table 94).

This proposed requirement is close to Swiss standard SN 520 380/4 but with simplified light distribution classes and with an adapted definition of LER, more information see sections 8.1.1.1 and 1.2.1.

Because the application of the luminaire is unknown during the putting on the market it is recommended to consider implementing measures affecting all LFL and CFL-ni luminaires.

It is however recommended to reduce impact on well defined LFL and CFL-ni luminaires:

- existing very low cost luminaires (about 10 euro) with fluorescent lamps that are used in domestic applications with very cost sensitive consumers that might shift to other less efficient solutions;
- on other low cost luminaires are often installed in technical rooms (e.g. cellar) of building where they are not frequently used.

Therefore it is proposed to exclude 'bare batten' or 'strip luminaires' (IP2X) and luminaires with ingress protection grade IP4X or higher (e.g. water proof luminaires) from these requirements in the proposed implementing measure).

Please note that the luminaire classification system and LERc as proposed in 8.1.1.1 are new for the manufacturers and users. It should also be avoided that efficient technology is phased out for very special applications that were unknown in this study with a focus on office lighting. Therefore the following recommendations are made:

- Gradual implementation;
- Evaluation after a period of 18 months before raising the requirements in a second phase;
- Consider an exemption for luminaires that pass a second 'detailed optical performance evaluation' route, therefore they might comply with:
 - the complete CEN photometric data file (in EN 13032-2);
 - are equipped with electronic ballasts with efficiency equal or better compared to CELMA EEI = A2.
 - satisfy the requirements for fluorescent lamps (see 8.1.1.2);
 - passing a minimum value compatible with a second more refined luminaire classification and labelling system if it becomes available (e.g. from CELMA), this number could reflect the 'performance of the optical system'. In case that such a system becomes available it should also be evaluated after a period of 18 months, afterwards the minimum value can be raised.

It is also suggested to phase out explicitly new luminaires that are equipped with less efficient T5 HO lamps (Table 98) that were brought on the market a few years ago and that become increasingly popular for general illumination due to lower luminaire and lamp cost and architectural reasons. It is difficult to believe that these luminaires are functional essential as they did not exist 10 years ago.

Proposed timing:

It is recommended to start with label 'F' ASAP together with the introduction of the new labelling system and consider an exemption for luminaires that pass a second 'detailed optical performance evaluation' route;

It is recommended to switch to label 'E' after a transition period of 2 years and after a positive evaluation of the new labelling system(s).

It is also recommended to reconsider after the transition period of 18 months the second more refined luminaire classification route and scheme if it becomes available (e.g. from CELMA). It is also suggested to explicitly phase out new luminaires that are equipped with new T5 HO lamps (Table 98).

8.1.2 Scenario analysis

This section draws up scenarios 1990-2020 quantifying the improvements that can be achieved versus a Business-as-Usual (BAU) scenario.

An overview of the main input parameters regarding trends (1990-2020) and EU25-totals from chapter 2 are given in the following table:

Table 101 Scenario parameters

Scenario parameter (1)	unit	1990	2005	2020
Cellular Offices	%	55%	48%	40%
Open plan (landscape) Offices	%	45%	52%	60%
A1 direct lighting	%	80%	73%	65%
A2 direct+indirect lighting	%	20%	27%	35%
EU25 total office space	km ²	846,3	1.139	1.532,9
Annual office space increase	%	2,0%		
Annual office space increase	km ²	16,92	22,78	30,66
Share of total office area used as task area	%	60%	60%	60%
Average \bar{E}_m (stock)	lx	400	400	475
Average \bar{E}_m (new)	lx	400	500	500

Scenario parameter (2)	unit	
functional luminaire life	y	20
labour cost	€/h	31,83
t-luminaire install	min.	20
t-group relamping	min.	3
t-spot relamping	min.	20
t-luminaire cleaning (extra to relamping)	min.	1,5
period maintenance	y	2
interest rate	%	3,9
inflation rate	%	2,1
discount rate	%	1,8
PWF	y	16,7
kWh price	€/kWh	0,09
Year of implementing measures		2010
Share (of stock) implemented at 2020	%	50%

Input parameters regarding individual base cases and options are given in chapter 5 (definition base case) and chapter 6 (options). Table 102 gives an overview of the references to the data in this report that were used for the BAT and Mini-BAT scenarios.

For the scenarios ‘options 4+6+8+14’ (Mini-BAT) and BAT, it is assumed that the related implementing measures will be in force from 2010 on. This means with a luminaire life of 20 years, by 2020 50% of the existing stock will have been replaced with these luminaires.

The reference scenario for comparison is the BAU scenario. In a sense, the BAU scenario can be considered ‘optimistic’ because BAU assumes exclusively the use of luminaires with triphosphor lamps (from 1990 on) as explained in chapter 5. The energy use would not be affected at individual product level or even at EU25 total-level in case these triphosphor lamps are replaced with halophosphate lamps in existing luminaires. However if the performance of the luminaires and installations (lx) are calculated and determined based on less efficient halophosphate lamps, more luminaires are required per surface of office area to meet these standard requirements (500 lx) and thus affects the EU25-total result.

Table 102: References to data in report for BAT scenarios

Option	Used in scenario	Description	Lumin. A1	Lumin. A2	See Table
Option 1	BAT & MiniBat	T8 halophosphate to triphosphor lamps	X	X	60
Option 6	BAT & MiniBat	improved LMF at 4 years	X	X	87
Option 8	BAT & MiniBat	UFR BAT median	X	X	68, 88
Option 4	MiniBat	minimum ballast EEI-class set to A2 BAT	X	X	63, 85
Option 11	BAT	daylight control and individual dimming	X	X	63, 89
Option 14	BAT & MiniBat	use of High Efficiency T5 lamps		X	60

To indicate this difference regarding halophosphate versus triphosphor luminaires in EU25-totals; a worst case (WC) scenario is introduced. A more reliable indication of the improvements that can be achieved by implementing BAT are in the range comparing it versus the Business-as-Usual baseline (BAU) and the Worst-Case (WC) baseline. This principle is shown in the following figure; BAU is indicated by the blue line, WC by the yellow line. The blue striped line is the 1990 situation baseline for BAU, the yellow striped line the 1990 baseline for WC. Reality is between both lines (indicated in red) but because no reliable data is available on the share of halo- versus triphosphor installations, this (red) line cannot be exactly situated. We therefore prefer to indicate improvement potentials as ranges: where the green line represents the BAT scenario, the increase since 1990 is indicated by ‘a’ and ‘b’, respectively the “increase since 1990 (WC) to 2020 (BAT)” and the “increase since 1990 (BAU) to 2020 (BAT)”.

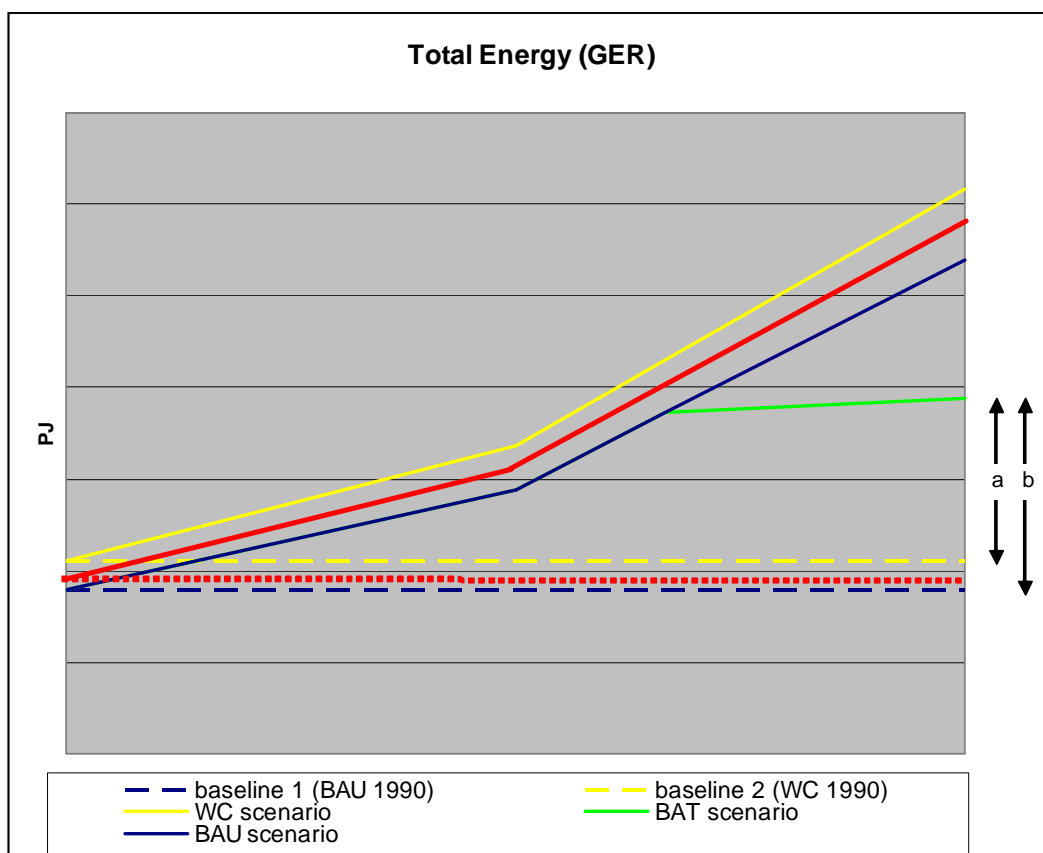

Figure 58: principle that real saving potential is between ‘a’ (relative to worst case) and ‘b’ (relative to standard base case)

Besides an ‘optimistic’ assumption in the defined base cases that only triphosphor lamps are used, another assumption in the base cases is that exclusively magnetic ballasts are used for category A1 luminaires with EEI = B2 and electronic ballasts with EEI=A2 for category A2. As mentioned before in chapter 5, one should take into account the real-life phase out, in new installations, of ballast EEI-classes D and C by 2002 and 2005 respectively (Directive 2000/55/EC). CELMA provided sales data of ballasts, according to EEI-class (see section 2.2.4). From this, in combination with available ballast stock data (see section 2.2.6), estimations were made on the share in the installed base of office luminaires with lamps driven by ballasts, according to EEI-class. The energy use per 1000 lumen functional output

(parameter Eye/FU) for the defined base cases (chapter 5) can now be compared with that from real-life, according to ballast EEI-mix⁶³ and the correction factor “Overall Improvement Ratio Stock versus Base case” can be derived⁶⁴. These data are shown in the following Table 103. From this it can be concluded that, for the stock or installed base, 1990 use-phase values based on base case assumptions are 6% underestimated due to not taking into account real-life ballast mix. For the reference year 2005, the base case with real-life stock values are almost exactly the same indicating that the defined base cases are indeed representative for the current installed base. For 2020, base case values generate a 7% overestimation because the significant increase in the use of more efficient electronic ballasts is not taken into account (CELMA projection, Ballast Guide). For the scenario analysis, the use-phase impacts in BAU and WC are therefore multiplied with these correction factors in order to take into account these real-life ballast mixes and the evolution herein.

Table 103: Average ballast EEI-class in the installed base and derived correction factors

Table. Correction factors for scenario-analysis, use phase		1990	2005	2020
Average Ballast Class for Office Lighting (Installed base)	% C and D	100%	65%	21%
	% B	0%	9%	19%
	% A	0%	26%	60%
Average Ballast Class for Office Lighting (Sales)	% C and D	100%	40%	0%
	% B	0%	25%	15%
	% A	0%	35%	85%
Ey/FU, STOCK, Base case (EEI=B2 for luminaire A1; EEI=A2 for luminaire A2)	kWh/1000l m	103,7	103,5	103,3
Ey/FU, STOCK, Real life (EEI according to above distribution for stock)	kWh/1000l m	109,5	103,4	96,5
Ey/FU, SALES, Real life (EEI according to above distribution for sales)	kWh/1000l m	109,5	100,6	91,7
Overall Improvement Ratio STOCK vs. BASESCASE, use phase		1,06	1,00	0,93
Overall Improvement Ratio SALES vs. BASESCASE, use phase		1,06	0,97	0,89

8.1.2.1 Business as Usual (BAU) scenario

The installed base of luminaires and the growth rate is based on the current amount and the expected growth of office space. In section 8.1.3.3 the uncertainty on the base assumptions influencing the results regarding EU25 stock and sales are discussed in detail.

The business as usual scenario is drawn up using the EcoReports of the 4 different defined Base case luminaires (see chapter 4). This means the assumption is made that from 1990 since, only triphosphor luminaires are installed and lamps are always replaced with triphosphor.

⁶³ In the EcoReports of the basecases, values on ballast efficiency were set for EEI-classes A, B, C accordingly (data retrieved from CELMA Ballast Guide) to define these Ey/FU.

⁶⁴ As Real life (Ey/FU) divided by Basecase (Ey/FU)

Table 104. Aggregated results, Scenario BAU

DATA	Unit	EU-total Impact of STOCK of Products in year: (produced, in use, discarded)			increase 1990 (BAU) to 2020 (BAU)
		1990	2005	2020	
Annual Sales Luminaires	mIn.	6,5	11,1	15,2	133%
Annual Sales Lamps	mIn.	39,1	50,3	75,9	94%
Stock Luminaires	mIn.	93,3	127,3	206,0	121%
Other Resources & Waste					
Annual Electricity use	TWh	21,2	26,5	38,7	83%
Total Energy (GER)	PJ	227,5	287,0	417,8	84%
of which, electricity (in primary PJ)	PJ	222,4	278,5	406,2	83%
Water (process)	mIn.m3	14,9	18,7	27,2	83%
Water (cooling)	mIn.m3	591,6	739,9	1079,7	82%
Waste, non-haz./landfill	Kt	377,9	525,1	743,6	97%
Waste, hazardous/incinerated	Kt	5,7	7,4	10,7	86%
Emissions (Air)					
Greenhouse Gases in GWP100	Mt CO2 eq.	10,1	12,8	18,6	84%
Ozone Depletion	t R-11 eq.	0,0	0,0	0,0	
Acidification	Kt SO2 eq.	58,9	74,4	108,2	84%
Volatile Organic Compounds (VOC)	Kt	0,1	0,1	0,2	93%
Persistent Organic Pollutants (POP)	g i-Teq.	2,6	3,8	5,3	103%
Heavy Metals	T Ni eq.	4,4	5,8	8,3	89%
PAHs	T Ni eq.	1,2	1,9	2,7	114%
Particulate Matter (PM, dust)	Kt	2,2	3,1	4,4	103%
Emissions (Water)					
Heavy Metals	T Hg/20	2,0	2,7	3,8	95%
Eutrophication	Kt PO4	0,0	0,0	0,0	100%
Annual Expenditure, total	mIn. €	3024,8	4351,5	6457,4	113%
Purchase, luminaires	mIn. €	795,1	1507,6	2273,4	186%
Purchase, installation costs	mIn. €	69,3	118,2	161,1	133%
Operating expense, electricity use	mIn. €	1900,9	2376,9	3468,6	82%
Operating expense, lamp replacement	mIn. €	95,4	125,6	195,2	105%
Operating expense, ballast replacement	mIn. €	3,5	6,2	12,6	
Operating expense, maintenance	mIn. €	160,6	216,8	346,5	116%

Table. Contribution to EU25

DATA	Unit				
Total EU25 energy use (GER)	Mtoe		1637,2		
Lot 8 Office Lighting, Total Energy (GER)	Mtoe	5,4	6,9	10,0	84%
Contribution Lot 8 to EU25 total energy use	%		0,42%		

*Figures are rounded

Taking into account the expected trends of office space growth and the increase in installed light output (towards 500 lx) the annual sales and stock of luminaires and lamps will as a consequence grow substantially. Annual electricity use will increase by 83% from 1990 to 2020 and the same goes for all environmental impacts because electricity use is the determining factor in the total life cycle environmental impact. Due to the shift to relatively more expensive

A2 luminaires substituting A1 luminaires, the annual expenditure will more than double (increase of 113% in 1990 to 2020).

In absolute figures total annual expenditure related to (functional) office task area lighting is in the order of 4351 mln.€ anno 2005 and 6457 mln. € anno 2020 (meaning doubled since 1990). Total energy use is 7 Mtoe, which is about 0,42% of total annual EU25 energy demand.

8.1.2.2 Worst Case (WC) scenario with halophosphate lamps

As indicated in 8.1.2, it is not realistic to assume that no halophosphates are installed in office lighting. For this reason, this 'worst case' (WC) scenario is drawn up to create a clear picture of the benefits that could be realized if a shift from 100% halophosphate to 100% use triphosphor is endeavoured and also to indicate the magnitude of the range BAU versus WC in between which the real life baseline is situated.

Comparing BAU with WC gives us an indication of 'real life' annual energy consumption and the uncertainty regarding the assumption of using only triphosphor luminaires in the base cases and thus BAU scenario (see Table 105). It is not known to what share of the office lighting stock is in reality using halophosphate versus triphosphor lamps.

From these 2 scenarios it can be concluded that EU25-total energy use, anno 2005, will be in the range between 7 Mtoe and 9 Mtoe (average 8 Mtoe +/- 13%), and annual expenditure between 4351 and 5403 mln. €. (average 4877 mln.€, +/- 11%).

From the economic and market analysis, an indication was given that relatively more halophosphate are being used compared to triphosphor (70% versus 30%) but this was indicative for all lighting applications (including domestic). Although it might be assumed that nowadays more luminaires for office use are calculated and installed initially with triphosphor, these lamps might be replaced with halophosphate during their operational life due to lower (lamp) costs. This has no effect on total energy use, but mainly will have its effect on installed light output (lx) which will decrease, and on environmental effects due to an increased use and consequent emission of mercury (10mg compared to 5mg of Hg content triphosphor versus halophosphate).

The benefit of using triphosphor lamps versus halophosphate lamps is clear when comparing the values on impacts and costs from Table 104 with those from Table 105. For the reference year 2005, 90 PJ primary energy can be saved by using luminaires with triphosphor lamps instead of halophosphate luminaires and savings in annual expenditure up to 1 billion €. In a scenario where all luminaires with halophosphate in 1990 (WC, 1990) are substituted by luminaires with triphosphor in 2020 (BAU, 2020); the EU25 electricity use, impacts, costs, etcetera would still increase (see last column in Table 105), but not as significant as in a worst case scenario where no substitution would take place (see 2nd last column in Table 105).

Table 105 Aggregated results, Worst Case Scenario (halophosphate)

DATA	Unit	EU-total Impact of STOCK of Products in year: (produced, in use, discarded)			increase 1990 (WC) to 2020 (WC)	increase 1990 (WC) to 2020 (BAU)
		1990	2005	2020		
Annual Sales Luminaires	mIn.	8,5	14,2	18,8	121%	78%
Annual Sales Lamps	mIn.	53,3	67,7	100,6	89%	42%
Stock Luminaires	mIn.	121,8	162,2	255,3	110%	69%
Other Resources & Waste						
Annual Electricity use	TWh	28,3	34,8	49,6	75%	36%
Total Energy (GER)	PJ	304,2	376,3	535,5	76%	37%
of which, electricity (in primary PJ)	PJ	297,6	365,4	521,0	75%	36%
Water (process)	mIn.m3	19,9	24,5	34,9	75%	37%
Water (cooling)	mIn.m3	791,5	970,9	1384,9	75%	36%
Waste, non-haz./landfill	Kt	503,0	683,8	945,7	88%	48%
Waste, hazardous/incinerated	Kt	7,7	9,7	13,7	78%	39%
Emissions (Air)						
Greenhouse Gases in GWP100	Mt CO2 eq.	13,5	16,7	23,8	77%	38%
Ozone Depletion	t R-11 eq.	0,0	0,0	0,0		
Acidification	Kt SO2 eq.	78,7	97,5	138,7	76%	37%
Volatile Organic Compounds (VOC)	Kt	0,1	0,2	0,3	85%	45%
Persistent Organic Pollutants (POP)	g i-Teq.	3,5	4,9	6,7	94%	53%
Heavy Metals	T Ni eq.	5,9	7,6	10,6	81%	41%
PAHs	T Ni eq.	1,6	2,5	3,3	103%	62%
Particulate Matter (PM, dust)	Kt	2,9	4,0	5,5	94%	53%
Emissions (Water)						
Heavy Metals	T Hg/20	2,6	3,5	4,9	86%	46%
Eutrophication	Kt PO4	0,0	0,0	0,0	91%	50%
Annual Expenditure, total	mIn. €	3876,7	5402,9	7816,2	102%	67%
Purchase, luminaires	mIn. €	948,9	1742,4	2553,0	169%	140%
Purchase, installation costs	mIn. €	90,4	150,6	199,6	121%	78%
Operating expense, electricity use	mIn. €	2543,1	3118,9	4449,2	75%	36%
Operating expense, lamp replacement	mIn. €	79,3	105,9	167,3	111%	146%
Operating expense, ballast replacement	mIn. €	3,5	6,2	12,6		259%
Operating expense, maintenance	mIn. €	211,5	279,0	434,5	105%	64%

Table. Contribution to EU25

DATA	Unit					
Total EU25 energy use (GER)	Mtoe		1637,2			
Lot 8 Office Lighting, Total Energy (GER)	Mtoe	7,3	9,0	12,8	76%	37%
Contribution Lot 8 to EU25 total energy use	%		0,55%			

8.1.2.3 Mini-BAT scenario

This scenario implements simultaneous all the options defined for Mini-Bat (options 4, 6, 8, 14) with the exception of dimming (option 11), but instead as a minimum using ballast of EEI-class A2 (option 3). This scenario can also be used for impact analysis to other areas where dimming has less benefits.

In Table 106 the results of the MiniBat scenario are shown.

Table 106 Aggregated results, Scenario Minimum BAT (MiniBat)

DATA	Unit	EU-total Impact of STOCK of Products in year: (produced, in use, discarded)			Increase 1990 (BAU) to 2020 (MiniBat)	savings compared to 2020 (BAU)	savings compared to 2020 (WC)
		1990 (BAU)	2005 (BAU)	2020 (MiniBat)			
Annual Sales Luminaires	mln.	6,5	11,1	14,7	126%	-3%	-22%
Annual Sales Lamps	mln.	39,1	50,3	63,7	63%	-16%	-37%
Stock Luminaires	mln.	93,3	127,3	200,0	114%	-3%	-22%
Other Resources & Waste							
Annual Electricity use	TWh	21,2	26,5	31,2	47%	-19%	-37%
Total Energy (GER)	PJ	227,5	287,0	338,5	49%	-19%	-37%
of which, electricity (in primary PJ)	PJ	222,4	278,5	327,4	47%	-19%	-37%
Water (process)	mln.m3	14,9	18,7	21,9	47%	-19%	-37%
Water (cooling)	mln.m3	591,6	739,9	869,7	47%	-19%	-37%
Waste, non-haz./landfill	Kt	377,9	525,1	634,3	68%	-15%	-33%
Waste, hazardous/incinerated	Kt	5,7	7,4	8,6	50%	-19%	-37%
Emissions (Air)							
Greenhouse Gases in GWP100	Mt CO2 eq.	10,1	12,8	15,1	50%	-19%	-37%
Ozone Depletion	t R-11 eq.	0,0	0,0	0,0			
Acidification	Kt SO2 eq.	58,9	74,4	87,7	49%	-19%	-37%
Volatile Organic Compounds (VOC)	Kt	0,1	0,1	0,2	64%	-15%	-33%
Persistent Organic Pollutants (POP)	g i-Teq.	2,6	3,8	4,7	78%	-12%	-31%
Heavy Metals	T Ni eq.	4,4	5,8	6,9	56%	-17%	-35%
PAHs	T Ni eq.	1,2	1,9	2,4	96%	-8%	-27%
Particulate Matter (PM, dust)	Kt	2,2	3,1	3,8	78%	-12%	-31%
Emissions (Water)							
Heavy Metals	T Hg/20	2,0	2,7	3,2	64%	-15%	-34%
Eutrophication	Kt PO4	0,0	0,0	0,0	71%	-14%	-33%
Annual Expenditure, total	mln. €	3024,8	4351,5	6016,7	99%	-7%	-23%
Purchase, luminaires	mln. €	795,1	1507,6	2560,8	222%	13%	0%
Purchase, installation costs	mln. €	69,3	118,2	156,4	126%	-3%	-22%
Operating expense, electricity use	mln. €	1900,9	2376,9	2793,9	47%	-19%	-37%
Operating expense, lamp replacement	mln. €	95,4	125,6	164,1	72%	-16%	-2%
Operating expense, ballast replacement	mln. €	3,5	6,2	18,9		51%	51%
Operating expense, maintenance	mln. €	160,6	216,8	322,5	101%	-7%	-26%

Table. Contribution to EU25

DATA	Unit						
Total EU25 energy use (GER)	Mtoe		1637,2				
Lot 8 Office Lighting, Total Energy (GER)	Mtoe	5,4	6,9	8,1	49%	-19%	-37%
Contribution Lot 8 to EU25 total energy use	%		0,42%				

8.1.2.4 Best Available Technology (BAT) scenario

The BAT scenario is the simultaneous implementation of the options 6 (improved LMF), 8 (improved UF), 11 (electronic dimmable ballast) and 14 (increased efficiency of T5 lamp). LMF&RSMF compensation is not considered in the BAT scenario because LMF&RSMF compensation is almost useless when simultaneously implementing option 6. MiniBat and a BAT scenario are differentiated because manual dimming control and daylight responsive dimming can be implemented both at product or at installation level.

Table 107 presents the results of the BAT scenario analysis.

Table 107 Aggregated results, Best Case Scenario (BAT)

DATA	Unit	EU-total Impact of STOCK of Products in year: (produced, in use, discarded)			increase 1990 (BAU) to 2020 (BAT)	savings compared to 2020 (BAU)	savings compared to 2020 (WC)
		1990 (BAU)	2005 (BAU)	2020 (BAT)			
Annual Sales Luminaires	mIn.	6,5	11,1	14,7	126%	-3%	-22%
Annual Sales Lamps	mIn.	39,1	50,3	63,7	63%	-16%	-37%
Stock Luminaires	mIn.	93,3	127,3	200,0	114%	-3%	-22%
Other Resources & Waste							
Annual Electricity use	TWh	21,2	26,5	26,5	25%	-31%	-47%
Total Energy (GER)	PJ	227,5	287,0	289,4	27%	-31%	-46%
of which, electricity (in primary PJ)	PJ	222,4	278,5	278,3	25%	-31%	-47%
Water (process)	mIn.m3	14,9	18,7	18,7	25%	-31%	-47%
Water (cooling)	mIn.m3	591,6	739,9	739,0	25%	-32%	-47%
Waste, non-haz./landfill	Kt	377,9	525,1	577,4	53%	-22%	-39%
Waste, hazardous/incinerated	Kt	5,7	7,4	7,5	30%	-30%	-45%
Emissions (Air)							
Greenhouse Gases in GWP100	Mt CO2 eq.	10,1	12,8	12,9	29%	-30%	-46%
Ozone Depletion	t R-11 eq.	0,0	0,0	0,0			
Acidification	Kt SO2 eq.	58,9	74,4	75,0	28%	-31%	-46%
Volatile Organic Compounds (VOC)	Kt	0,1	0,1	0,2	47%	-24%	-40%
Persistent Organic Pollutants (POP)	g i-Teq.	2,6	3,8	4,3	66%	-18%	-36%
Heavy Metals	T Ni eq.	4,4	5,8	6,0	37%	-27%	-43%
PAHs	T Ni eq.	1,2	1,9	2,3	88%	-12%	-30%
Particulate Matter (PM, dust)	Kt	2,2	3,1	3,6	66%	-18%	-35%
Emissions (Water)							
Heavy Metals	T Hg/20	2,0	2,7	2,9	48%	-24%	-40%
Eutrophication	Kt PO4	0,0	0,0	0,0	59%	-21%	-38%
Annual Expenditure, total	mIn. €	3024,8	4351,5	5842,1	93%	-10%	-25%
Purchase, luminaires	mIn. €	795,1	1507,6	2800,4	252%	23%	10%
Purchase, installation costs	mIn. €	69,3	118,2	156,4	126%	-3%	-22%
Operating expense, electricity use	mIn. €	1900,9	2376,9	2373,5	25%	-32%	-47%
Operating expense, lamp replacement	mIn. €	95,4	125,6	164,1	72%	-16%	-2%
Operating expense, ballast replacement	mIn. €	3,5	6,2	25,2		101%	101%
Operating expense, maintenance	mIn. €	160,6	216,8	322,5	101%	-7%	-26%

Table. Contribution to EU25

DATA	Unit						
Total EU25 energy use (GER)	Mtoe		1637,2				
Lot 8 Office Lighting, Total Energy (GER)	Mtoe	5,4	6,9	6,9	27%	-31%	-46%
Contribution Lot 8 to EU25 total energy use	%		0,42%				

8.1.2.5 Conclusions

Results on total EU25 (primary) energy use and annual expenditure for the period 1990-2020 are shown in the following Figure 59 and Figure 60.

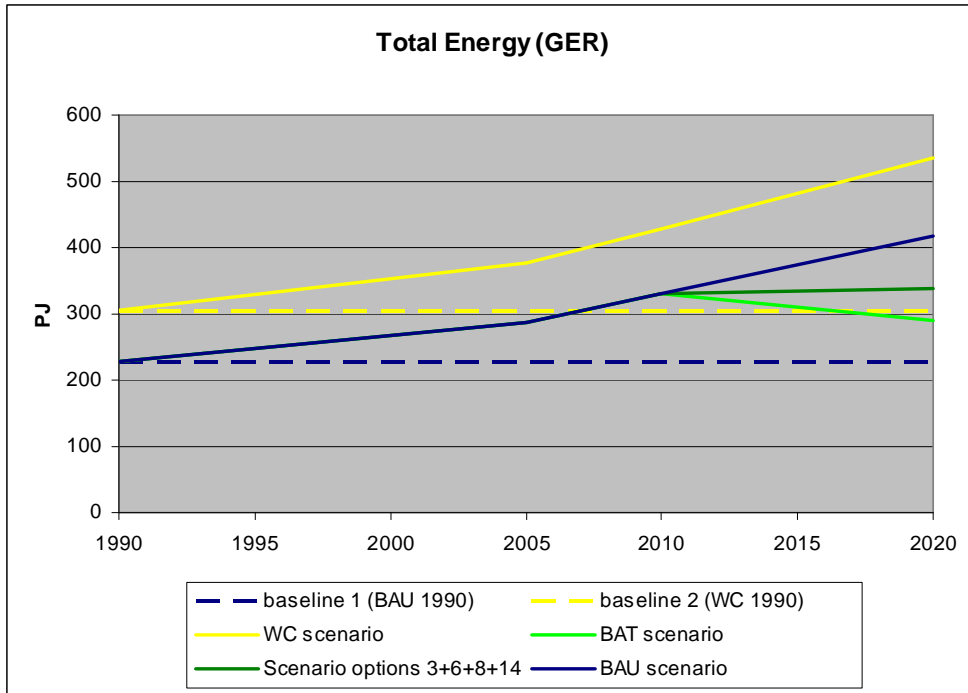

Figure 59: Scenario's Total Energy (GER)

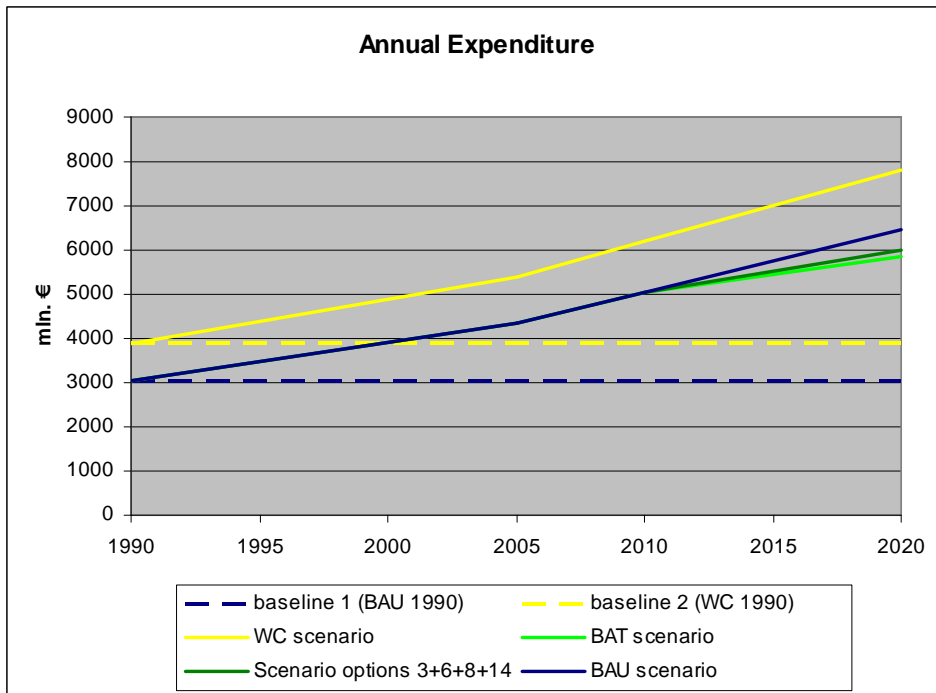

Figure 60: Scenario's Total Annual Expenditure

In 2020, BAT 2020 compared to BAU 2020 would generate an energy saving of 31% (i.e. 31% less energy consumption); BAT 2020 compared to WC 2020 even generates an energy saving of 47% (i.e. 47% less consumption). The total expenditure saving in implementing BAT would result in 2020 in an economy of 10% compared to BAU (i.e. 10% less) and in comparing BAT 2020 to WC 2020 in an economy of 25% (i.e. 25% less).

The study clearly shows that the expected increase in purchase and installation costs for new luminaires are compensated by savings in the use phase of the products. Compared to 2020, BAU, purchase costs will increase by 23% while operating expenses will drop by 32% regarding electricity use and by 16% regarding lamp replacement costs. Due to the dominance of the electricity cost in the LCC, total annual expenditure is 10% compared to BAU 2020.

When options would be implemented individually, the trend in the use of energy would reduce in relative terms compared to a BAU scenario (so called “relative decoupling”) but not in absolute terms (“absolute decoupling”). Even when all options are implemented simultaneously except dimming, thus scenario MiniBat, energy use would slightly but still increase annually. Only BAT, thus implementing all available technologies to save electricity use could generate an absolute reduction of total EU25 energy use and impacts. Of course, these projections do not take into account the not yet available technologies which could help reaching this absolute decoupling objective for office lighting (for example LED, see section 6.3).

In 2020 when BAT would be 50% absorbed by the stock (implementation since 2010 and average luminaire life of 20 years) no EU25-total energy and no expenditure saving can be achieved (yet) compared to 1990 BAU-levels. On the other hand, the figure clearly shows that in the BAT scenario, energy savings at product (and installation) level compensate more than proportional the increase in office space, increase in installed luminaires and increase in illuminance levels. Already in 2020, BAT energy use drops below WC 1990 levels and is expected to do so also below BAU 1990 levels but only after 2020, when BAT is fully absorbed in the stock. In case of faster replacement of old luminaires in a period of 10 to 13 years, one could already achieve this by 2020 (see sensitivity analysis, section 8.1.3.3).

From a total life cycle cost perspective, annual expenditure in case of BAT is about the same as for MiniBat (5,8 billion versus 6 billion or 3% difference). On the other hand, energy use in 2020 is much lower in case of BAT compared to MiniBat (26,5 TWh versus 31,2 TWh or 15% less) and this difference will only grow as these new luminaires become more absorbed by the stock.

8.1.3 Sensitivity analysis

The main purpose of this section is to verify the robustness of the outcome with regard to the main parameters in this study.

8.1.3.1 Main parameters influencing the energy efficiency (E_y/FU)

The main parameter influencing the results on the energy efficiency of office lighting luminaires is the representativeness of the UFr-values for the base case luminaires. As shown in Table 70 in section 4.3.1.5 values can differ substantially at the level of one type of luminaire, with an uncertainty of up to 20-40% (depending on luminaire type). In the base cases, the median values of the examined luminaires in the technical analysis were chosen as reference values (see section 4.3.1.5). No data or studies are however available to verify if these values are representative for the real average EU25 installed base 1990 to 2020.

In the following analysis, not the UFr median, but the 25% value between UFr min and UFr max was used for calculating the Ey/FU parameters and EU25-totals scenario. Outcome is shown in the following table and figure.

Table 108: functional lumen output per luminaire (kWh/1000lm per year)

Ey/FU (2005) [kWh/1000 lm]	A1, cellular	A1, open	A2, cellular	A2, open
BAU Base cases (UFr median)	104,16	96,53	101,77	73,80
BAU Sens. Analysis (UFr 25%)	127,14	124,06	117,06	80,79

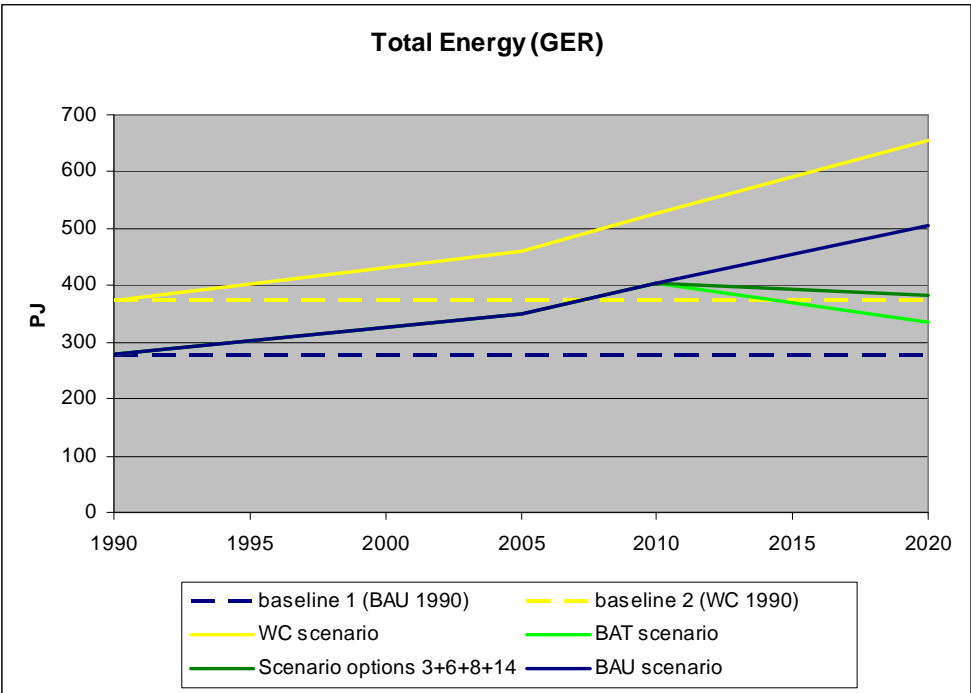

Figure 61: Total EU25 Energy Use (PJ primary) when changing UF-values

Lowering UFr-values would mean that more luminaires are required to lit the same amount of office space at 500 lx illuminance. This is taken into account in the model. Indeed, the stock of luminaires in 2005 would increase from 127 million luminaires (under the base case assumption) to 154 million luminaires and sales would increase from 11 million luminaires to 13,5 million luminaires. Because more luminaires need to be installed to maintain this 500 lx illuminance, (primary) energy use will increase from 287 PJ to 350 PJ in 2005, i.e. an increase by 22%.

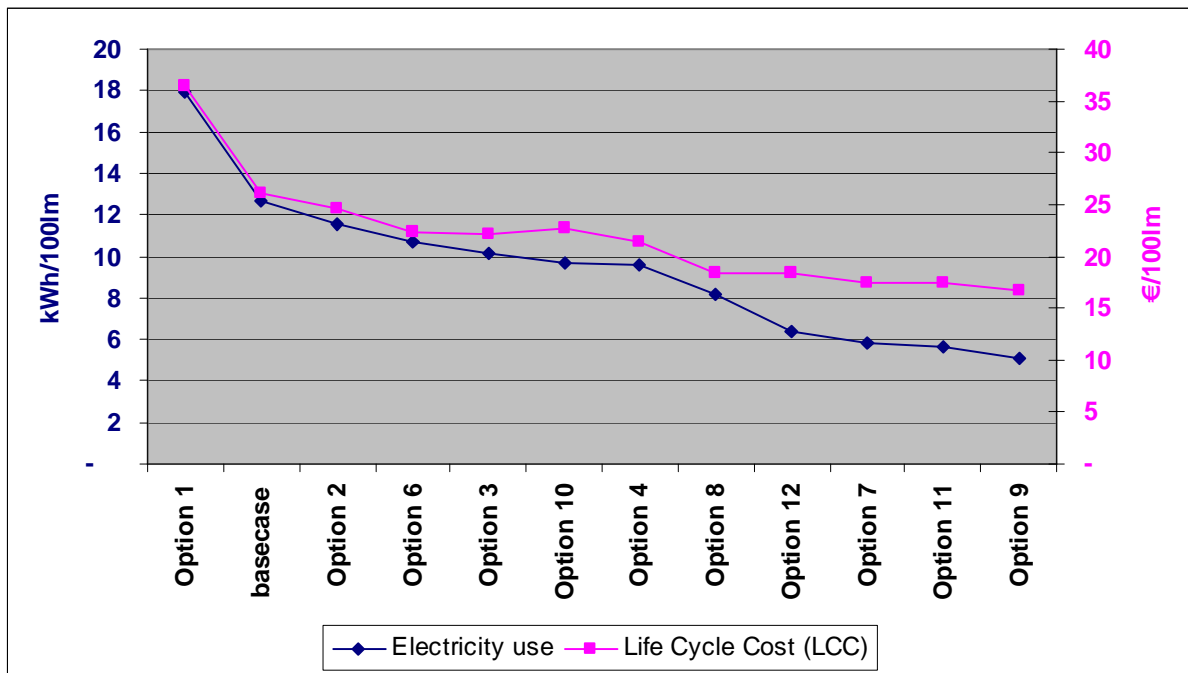

Figure 62: Ranking of options for type A1 luminaires (cellular offices) when base case UFr is set at the UFr 25% of technically assessed luminaires.

When real life UFr values of office luminaires are worse than what is assumed in this study, i.e. that the UFr median is only UFr 25% of the assessed luminaires, also the ranking of improvement options changes: ranking stays the same for all options except for option 8 (using UFr BAT median) that will become better than option 4 while under the base case assumption its position was between option 3 and 10 (see section 7.2)

8.1.3.2 Main parameters influencing LCC

The following parameters can have a significant impact on the LCC calculation in this study:

1. Uncertainty regarding expected luminaire life
2. Uncertainty regarding electricity rate and product price
3. Uncertainty regarding maintenance practice (group/spot relamping and fixture cleaning)

Cost of electricity (use phase) versus cost of product in total life cycle cost

How will a general increase or decrease of these costs influence LCC?

Dropping product prices simply leads to the conclusion that all measures and proposed improvement options will not be influenced since electricity cost becomes even more dominant. On the other hand, increasing product prices and decreasing average luminaire life can affect this ratio. When e.g. luminaire life is set to 15 years (instead of 20y), in BAU the share of the product price in the total LCC increases to 32%. But even then, only when product price would increase with a factor 1,8 breakeven would be reached where product price becomes as relevant as electricity costs in the total LCC. This is not true for the BAT scenario; when luminaire life is set to 15 years, the share of the product price in the total LCC increases to 62% where the cost of electricity use is 26%. In absolute terms, BAT still generates the least life cycle costs (BAT=LLCC). This is shown in the following Table 109.

Table 109: LCC under base case assumptions, except luminaire life set to 15 years

	LCC, 2005 (sales)	BAU	BAT	MiniBat
D	Product price	135,31	221,82	250,00
E	Installation/ acquisition costs (if any)	10,61	10,61	10,61
F	Electricity	243,67	90,53	93,38
H	Aux. 1: lamp replacement (PP)	12,87	9,29	7,34
I	Aux. 2 :ballast replacement (PP)	0,64	2,54	1,89
K	Repair & maintenance costs	22,61	20,59	20,59
(K)	<i>(of which due to lamp replacement)</i>	13,73	11,24	11,24
	Total	425,71	355,37	383,80

The previous does not take into account changing electricity rates (€/kWh). It is very likely however that this will increase (given the current political discussion regarding climate change, availability of resources, increasing prices of energy and basic resources on the market, etcetera). This will even increase the dominance of the electricity use in the LCC and will actually improve the cost savings generated by the deliberated options and BAT. As such, it will not affect the results of this study. This can be seen in the following where the LCC results are depicted where luminaire life is set to 15 years (instead of 20) and the average electricity rate is set to 0,14 €/kWh.

Table 110: LCC under base case assumptions, except luminaire life set to 15 years and electricity rate set to 0,14 €/kWh

	LCC, 2005 (sales)	BAU	BAT	MiniBat
D	Product price	135,31	221,82	188,21
E	Installation/ acquisition costs (if any)	10,61	10,61	10,61
F	Electricity	379,05	140,82	238,18
H	Aux. 1: lamp replacement (PP)	12,87	9,29	9,29
I	Aux. 2 :ballast replacement (PP)	0,64	2,54	1,66
K	Repair & maintenance costs	22,61	20,59	20,59
(K)	<i>(of which due to lamp replacement)</i>	13,73	11,24	11,24
	Total	561,09	405,66	468,53

Real-life maintenance practice versus maintenance according to standard

Under the current base case, it is assumed that luminaire cleaning is systematically carried out every 2 years (according to CIE 97) for BAU and WC and every 4 years for BAT. This means, this servicing is also done when lamps do not yet need replacement. For example, in the base case luminaire A1, lamp replacement time is every 6 years (T8, triphosphor) and the luminaire is cleaned every 2 years. This means, every three times the luminaire is cleaned, also the lamps are replaced with new ones. But because, when cleaning the luminaire, lamps are always taken out and put in again⁶⁵, the (labour) time for group relamping is every time accounted for⁶⁶.

In real-life practice however, it is most likely that luminaire cleaning is not done at all or ideally only during group relamping to save costs. Maintenance personnel are already accessing the fixtures and removing lamps. Cleaning fixtures, lenses and diffusers at the same time will cost in addition to the cost of relamping about 0,8 € per fixture.

The table below shows the difference in maintenance costs, when systematically cleaning luminaires over a given period (2y for BAU, 4y for BAT) and when this is done only during group relamping.

Table 111: Maintenance costs under 2 different maintenance schemes

	LCC, 2005 (sales)	BAU	BAT	Options 3+6+8+14
Base case (systematic cleaning, every 2 years for BAU, every 4 years for BAT and 'options 3+6+8+14')				
K	Repair & maintenance costs	28,38	25,65	25,65
(K)	(of which due to lamp replacement)	17,54	14,37	14,37
Cleaning only during relamping				
K	Repair & maintenance costs	19,57	16,03	16,03
(K)	(of which due to lamp replacement)	17,54	14,37	14,37

8.1.3.3 Main parameters influencing EU25 totals

The main parameters influencing the EU25 totals are:

1. uncertainty regarding the average lux in the installed base of office lighting (and the trend) on the basis of which the amount of luminaires per surface task area are based;
2. uncertainty regarding the total office space in use, and explicitly used as task area. Thus, this combined with the previous: uncertainty regarding the EU25 total installed base of office luminaires.
3. Uncertainty regarding average annual burning hours determining the annual cost and impacts of the use phase.

⁶⁵ In case the lamp life has not exceeded, the old lamp is put back in. In case the lamp life has exceeded, a new lamp is put in.

⁶⁶ The maintenance costs, every 2 years are thus: Cost Labour [€/hr]*(time group replacement+time luminaire cleaning) [hr]

In the following sensitivity analysis, the average illuminance for the installed base is set to 300 lux for 1990 (350 lx for 2005), the average illuminance for new sales is set to 350 lx in 1990 (but still 500 lx from 2005 on) and 840 km² is taken as the reference value for the total EU25 office space (see section 2.2.2, derived from Novem and Ecofys studies).

Table 112: Total EU25 Energy Use (PJ primary)

Total Energy (GER)	1990	2005	2010	2020
baseline 1 (BAU 1990)	127	127	127	127
baseline 2 (WC 1990)	169	169	169	169
BAU scenario	127	183	217	287
WC scenario	169	239	282	367
BAT scenario	127	183	217	201
Scenario options 3+6+8+14	127	183	217	236

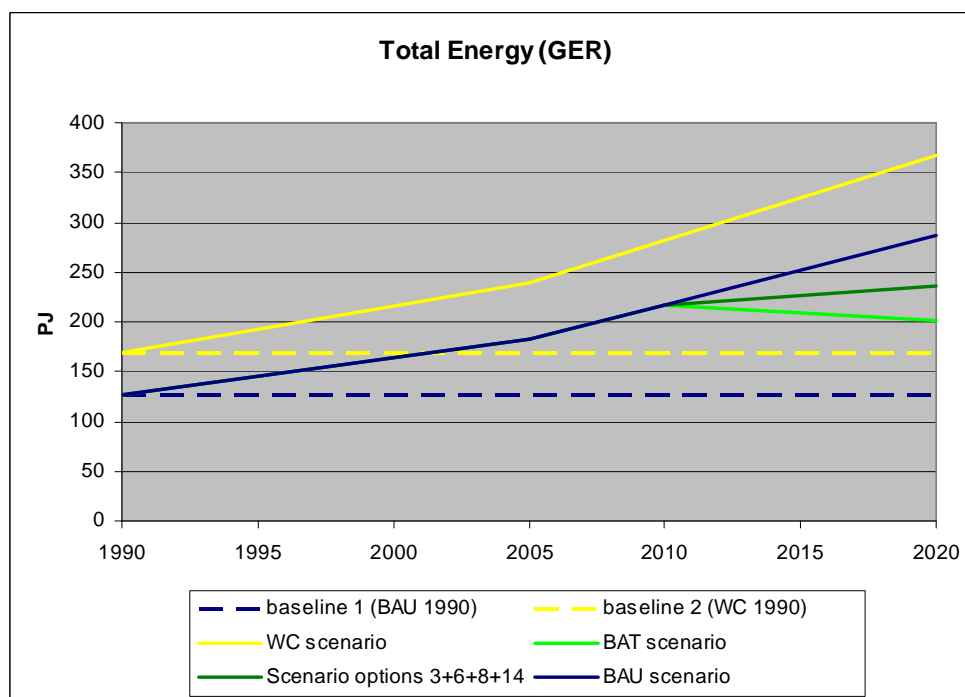

Figure 63: Total EU25 Energy Use (PJ primary)

Table 113: Total annual EU25 expenditure (mln.€)

Total Annual Expenditure	1990	2005	2010	2020
baseline 1 (BAU 1990)	1757	1757	1757	1757
baseline 2 (WC 1990)	2245	2245	2245	2245
BAU scenario	1757	2932	3479	4574
WC scenario	2245	3625	4257	5522
BAT scenario	1757	2932	3479	4191
Scenario options 3+6+8+14	1757	2932	3479	4312

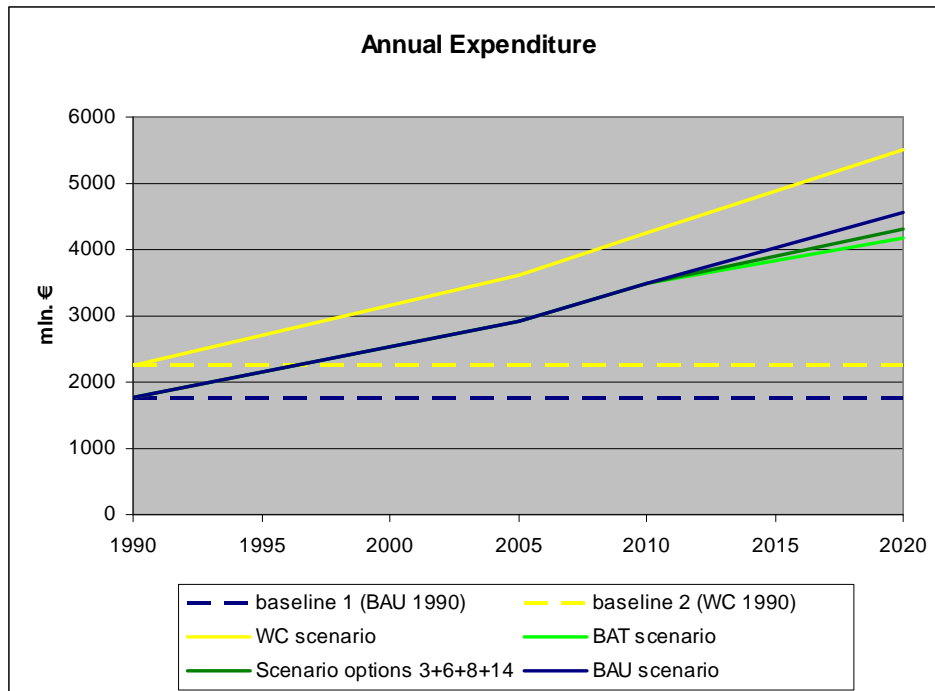

Figure 64: Total annual EU25 expenditure (mln.€)

Comparing these values to the results of section 8.2 clearly shows that the uncertainty of these parameters have a substantial impact on EU25 results and underlines the need for reliable data on the above parameters. Regarding the EU25 total office space, the data from Enerdata that is used in this study is considered more reliable and up to date for EU25 compared to the data derived from the Ecofys and Novem studies (already creating a 25% underestimation of EU25 totals). Most uncertain are the illuminance levels in the installed base and sales in the period 1990 up to today. Besides the expert enquiry and few studies carried out in several member state countries, data is relatively poor. Under the above mentioned assumptions on illuminance, an uncertainty of 27% to 33% due to this aspect for 1990 levels is shown, but this uncertainty generally decreases towards the future as more data is available and under the assumption that in 2020 almost all installations will meet the 500 lx standard.

Other parameters influencing EU25 totals, but of lower relevance are:

1. Reliability of the base cases as best approximation of the wide variety of office lighting products on the market and their related performance parameters.
2. Representativeness of the data on the share of A1 luminaires versus A2 luminaires.
3. Representativeness of the data on the share of open versus cellular offices.
4. Uncertainty regarding increase in annual office space combined with uncertainty regarding average luminaire life influencing the EU25 total annual sales of office luminaires.

The model is an approximation and simplification of ‘real life installed base’, but this is inherent to the method. This simplified modelling approach and the differentiation of the luminaires and office types influences EU25 totals to some extent, but does neither affect the ability of the model to capture and evaluate all considered options, nor it will affect the conclusion regarding the effectiveness of individual options, LLCC or BAT.

Regarding the annual increase in office space, very similar values around 2% per annum were found in various sources so it is likely that this aspect does not influence EU25 totals very much. Average luminaire life mainly affects the speed of replacing older, less efficient luminaires. On the other hand, this energy saving is more than compensated by an energy use increase due to the fact that older installations were calculated to provide generally less illuminance levels and newer installations have to comply to the 500 lx standard (in the BAU and WC scenario, this is shown by the substantial increase in energy use since 2005 on). Lowering the average luminaire life would mainly be beneficial for decreasing the EU25 energy use from office lighting by faster replacement of older luminaires with BAT luminaires. When setting the luminaire life to 15 years, this would mean that in a BAT scenario in 2020, almost 1990-levels would again be reached. This is shown in the table and figure below. When setting average luminaire life to 10-12 years, BAT levels in 2020 will be lower than BAU 1990 baseline.

Table 114: influence of lowering the average luminaire life to 15 years on EU25 energy use

Total Energy (GER)	1990	2005	2010	2020
baseline 1 (BAU 1990)	229	229	229	229
baseline 2 (WC 1990)	307	307	307	307
BAU scenario	229	284	330	422
WC scenario	307	372	428	541
BAT scenario	229	284	330	255
Scenario options 3+6+8+14	229	284	330	324

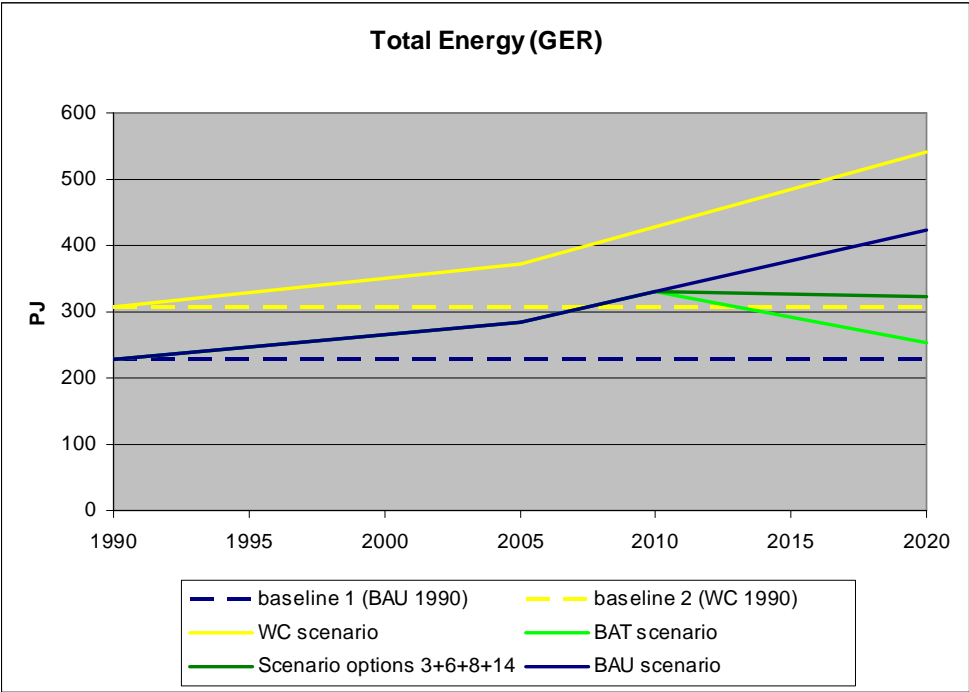

Figure 65: influence of lowering the average luminaire life to 15 years on EU25 energy use

8.1.3.4 Summary on sensitivity analysis

When taking into account the uncertainties, almost none of the individual options can be favoured comparing one to another.

The uncertainties can have an impact on 'estimated EU25 energy consumption' because they rely on the underlying assumptions of this study, however they do not influence the 'energy consumption in real life'.

8.1.4 Suggested additional requirements for the appropriate putting into service

Recommendation 1:

Clarification and less stringent requirements for the 'task area' and 'surrounding area' as defined in standard EN 12464 (2004). Because the standard EN 12464-1 specifies in the definition of 'task area' that 'for places where the size and/or location of the task area is unknown, the area where the task may occur shall be taken as the task area'. Therefore the task area and its requirements are 'fixed' with reference to the office rooms in the building and it can be deduced that therefore a 'fixed lighting installation' is required. The consequence is that in practice the fixed lighting installation is dimensioned for the high illuminance requirements of the task area. A more energy efficient approach would be to provide the illuminance requirement for the surrounding area with the fixed lighting installation and to provide energy efficient table lamps for additional lighting of the task area.

Recommendation 2:

It is recommended to develop specific and easy to understand technical requirements for installing luminaires in specific building types, the proposals are:

- Make compulsory the use or 'putting into service' of the defined luminaires in this study.
- Make compulsory the use of bright surfaces with minimum reflectance values (ceiling, floor, wall).
- Make compulsory the use of luminaires with daylight responsive dimming in daylight building areas (e.g. in 3 m from window).
- Specify the maximum size of control zones for lighting on/off switching or control (e.g. 8 m² as in the draft standard prEN 15193 (2006)). This enables people to switch off the light in selected areas of large rooms where no light is required.

It is clear that these requirements are easy to verify in the field during the putting into service, please note that this is not included in the actual implementation of the EPB directive (2002/92/EC).

It is also recommended to implement the calculation of the Lighting Energy Numerical Indicator (LENI) at installation level and set limits to it, more information is in draft standard prEN 15193 (2006) or in section 4.4.

Recommendation 3:

Review of the luminaire maintenance factors (LMF) specified in guideline CIE 97 (2005), it is also recommended to add a note in prEN 15193 when referring to this standard. It should be stated that the LMF values of CIE 97 (2005) are very pessimistic and conservative, leading to over dimensioning new build installations.

Recommendation 4:

Uniform and verifiable format of photometric data according to EN 13032-2(2004). Photometric data and power consumption of luminaires should be measured simultaneously and unambiguously with clear indication of applied 'Ballast Lumen factor', see chapter 4. Market surveillance is also strongly recommended.

Recommendation 5:

Installer education related to optimum lamp efficacy temperatures and catalogue data.

8.1.5 Required new or updated measurement or product standards

Recommendation 6:

Include the power saving 'cut off' technology (see chapter 6) requirement for electronic ballasts in the related EN 60929. This is related to stopping the preheating after lamp ignition. Please note that this improvement option is already implicit included in 8.1.1.3.

8.1.6 Suggested additional research

Easy and fast photometric evaluation of luminaires in order to achieve market surveillance. In 8.1.1.1 the nine numbers of the flux code are asked as generic information. It is important that this generic information can be verified fast and easy. For this purpose a complete photometric file (EN 13032-2) is not proposed as a minimum requirement because this measurement is time consuming and requires the use of a goniometer. Please note that the most important number, LOR, can be easily be verified in Ulbricht sphere. A new fast and easy method needs to be developed for the evaluation of the remaining numbers. Therefore a method could be developed based on a CCD camera in order to verify fast and simple the remaining 8 digits representing the light distribution.

8.2 Impact analysis industry and consumers

This section includes a supplementary qualitative impact analysis on industry and consumers, for the quantified impact (e.g. annual product sales volumes) please look at 8.1.2.

8.2.1 Potential application of the ecodesign requirements outside the defined product category

Beside office lighting there are many other buildings and activities for which functional interior lighting is required, hereafter is the list of interior area and tasks as identified in standard EN 124641 (2004):

Traffic zones and general areas inside buildings

- Traffic zones
- Rest, sanitation and first aid rooms
- Control rooms
- Store rooms/cold stores
- Storage rack areas

Industrial activities and crafts

- Agriculture
- Bakeries
- Cement, cement goods, concrete, bricks
- Ceramics, tiles, glass, glassware
- Chemical, plastics and rubber industry
- Electrical industry
- Food stuffs and luxury food industry
- Foundries and metal casting
- Hairdressers
- Jewellery manufacturing
- Laundries and dry cleaning
- Leather and leather goods
- Metal working and processing
- Paper and paper goods
- Power stations
- Printers
- Rolling mills, iron and steel works
- Textile manufacture and processing
- Vehicle construction
- Wood working and processing

Offices

Retail premises

Places of public assembly

- General areas
- Restaurants and hotels
- Theatres, concert halls, cinemas
- Trade fairs, exhibition halls
- Museums
- Libraries
- Public car parks (indoor)

Educational premises

- Nursery school, play school
- Educational buildings

Health care premises

- Rooms for general use
- Staff rooms
- Wards, maternity wards
- Examination rooms (general)
- Eye examination rooms
- Ear examination rooms
- Scanner rooms
- Delivery rooms
- Treatment rooms (general)
- Operating areas
- Intensive care units
- Dentists
- Laboratories and pharmacies
- Decontamination rooms
- Autopsy rooms and mortuaries

Transportation areas

- Airports
- Railway installations

The previous list gives an idea about how much more lighting applications exist. As a consequence office lighting is only a small part of the market for functional lighting equipment. Total sales figures of lamp sales data (Annex B) can be compared with the estimated lamp sales data (Table 104) in this study for estimating a leverage factor (Table 115), this leverage factor is about 6.

Table 115 Leverage factor for fluorescent lighting applications

Estimated lamp sales office lighting (LFL + CFL-ni) (2005)	Eurostat total LFL lamp sales (2004)	leverage factor
50.3000.000	309.999.694	6,2

As pointed out in the previous chapters of this study the major impact comes from energy use and this is much related to the operational hours. Therefore it is important to assess this, the next data (Table 116, Table 117) can be used for this purpose.

In more detailed impact assessment taking into account all possible applications is recommended.

Table 116 Typical annual operating hours (burning hours) according to CIE 97(2005)

Activity	Period of occupancy		Daylight link controls	Operating hours
	No. of days	Hours/day		
Industrial				
Continuous	365	24	no	8760
Process	365	24	yes	7300
Two shifts	310	16	no	4960
Six days/week	310	16	yes	3720
Single shift	310	10	no	3100
Six days/week	310	10	yes	1760
Single shift	258	10	no	2580
Five days/week	258	10	yes	1550
Retail				
Six days/week	310	10	no	3100
Offices				
Five days/week	258	10	no	2580
	258	10	yes	1550
Schools				
Five days/week	190	10	no	1900
	190	10	yes	1140
Hospital				
7days/week	365	16	no	5840
	365	16	yes	3504

Table 117 Typical annual operating hours (burning hours) according to prEN 15193 (annex F).

	Qual. class	Parasitic Emergency kWh/(m ² /year)	Parasitic Control kWh/(m ² /year)	PN W/m ²	t _D h	t _N h	F _E		F _C		F _D	
							no cte illiminance	cte illiminance	Manu	Auto	Manu	Auto
Office	*	1	5	15	2250	250	1	0,9	1	0,9	1	0,9
	**	1	5	20	2250	250	1	0,9	1	0,9	1	0,9
	***	1	5	25	2250	250	1	0,9	1	0,9	1	0,9
Education	*	1	5	15	1800	200	1	0,9	1	0,9	1	0,8
	**	1	5	20	1800	200	1	0,9	1	0,9	1	0,8
	***	1	5	25	1800	200	1	0,9	1	0,9	1	0,8
Hospital	*	1	5	15	3000	2000	1	0,9	0,9	0,8	1	0,8
	**	1	5	25	3000	2000	1	0,9	0,9	0,8	1	0,8
	***	1	5	35	3000	2000	1	0,9	0,9	0,8	1	0,8
Hotel	*	1	5	10	3000	2000	1	0,9	0,7	0,7	1	1
	**		5	20	3000	2000	1	0,9	0,7	0,7	1	1
	***	1	5	30	3000	2000	1	0,9	0,7	0,7	1	1
Restaurant	*	1	5	10	1250	1250	1	0,9	1	1	1	-
	**	1	5	25	1250	1250		0,9	1	1	1	-
	***	1	5	35	1250	1250	1	0,9	1	1	1	-
Sport places	*	1	5	10	2000	2000	1	0,9	1	1	1	0,9
	**	1	5	20	2000	2000	1	0,9	1	1	1	0,9
	***	1	5	30	2000	2000	1	0,9	1	1	1	0,9
Retail	*	1	5	15	3000	2000	1	0,9	1	1	1	-
	**	1	5	25	3000	2000	1	0,9	1	1	1	-
	***	1	5	35	3000	2000	1	0,9	1	1	1	-
Manufacture	*	1	5	10	2500	1500	1	0,9	1	1	1	0,9
	**	1	5	20	2500	1500	1	0,9	1	1	1	0,9
	***	1	5	30	2500	1500	1	0,9	1	1	1	0,9

with,

t_D : daylight time usage as operating hours during the daylight time, measured in hours

t_N : non-daylight time usage as operating hours during the non-daylight time, measured in hours.

8.2.2 Warnings for avoiding negative impact on consumers outside the defined product category

Up to our knowledge none.

8.2.3 Warnings and additional measures for avoiding potential negative impact on industry from products in the defined product category

The enforcement of electronic ballasts might affect some SMEs that produce magnetic control gear.

Some companies might experience/suffer severe competition if electronic control gear technology takes over the old ferromagnetic control gear technology because other production lines and technological competences are needed. The switch of ferromagnetic to electronic control gear could also affect the copper and silicon steel industry because lower volumes of this material are needed in this technology.

Making the application of standards related to eco-design mandatory might create additional administration and costs for industry. It should be noted that international standards as defined in chapter 1 (e.g. CIE and IEC standards) and that are related to eco-design are not free available and are copyright protected. These standards are sold electronically for about typically 1 euro per page and refer in many cases to many other standards. The trade in copies of these standards provides the main source of income to CIE and IEC. These standards are very technical and sometimes difficult to understand. The authorities could undertake further actions to make this information free and easy available.

8.2.4 Overall impact and conclusion when implementing the BAT scenario

The scenarios in this section pointed out that implementing BAT requirements in 2010, would require in 2020 an estimated energy saving of 26.5 TWh electricity use compared to 34.7 TWh for BAU in 2020 and a total expenditure saving of 10 % for BAT compared to BAU. Also a worst case (WC) scenario has been calculated that assumes the use of halophosphate lamps in new calculated installations; the estimated energy in 2020 is 38.7 TWh (WC) with a total expenditure increase of 25 %. The reality is probably in between WC and the BAU scenario, especially when considering fluorescent lighting in non professional lighting applications (e.g. domestic). The impact on global warming potential (GWP) is almost proportional, wherein 34.7 TWh electricity use (Business as Usual scenario) is equivalent to 15.6 Mt CO₂ eq (GWP). The estimated energy consumption in 2005 is 26.5 TWh; this is the same value as for BAT in 2020. The first reason for this status quo is that the BAU scenario assumed a continuous increase of office space in EU27 and that from 2005 on, there was an important driver for specifying higher illuminance requirements for office lighting when the new EN 12464-1 (2004) standard was introduced. It should also be noted that not all energy saving is realised in 2020 with an implementing measure introduced in 2010 because the service life of luminaires was estimated on 20 years.

Also a miniBAT scenario is calculated that assumes no application of dimming in luminaires; this corresponds with 31.2 TWh in 2020. Dimming provides not only daylight related saving but also allows to fine tune illuminance to the real task requirements and can allow compensation for luminaire and lamp performance decrease over time.

Excluding inefficient halophosphate fluorescent lamps is also beneficial for reducing mercury in the environment. This could also be achieved by a revision of the exceptions for fluorescent lamps in the ROHS directive.

Identical lighting technology is used in other professional indoor lighting applications as mentioned in chapter 8. The eco-design study is performed for the most typical office application environment and did allow to perform a clear functional analysis according to the MEEUP methodology. The EU25 total environmental impact is therefore assessed for the office task area application in the first place but based on total sales numbers a leverage factor can be estimated for extrapolation to other applications of identical products. This leverage factor for non office task area fluorescent lighting applications is estimated about a factor 6.

9 REFERENCES

- Ahun, (2007). Migrating from conventional sources to LEDs: findings of a lighting manufacturer, . Nahum, communication on ' International Workshop: Status, Prospects and Strategies for LEDs in General Lighting", Ispra, Italy, 3 & 4 May 2007.
- Atanasiu, B et al., 2005. Electricity end-use in buildings: a survey of new Member States and Candidate Countries. ECEEE 2005 summer study.
- Atkinson et al. 1992 Analysis of Federal Policy Options for Improving U.S. Lighting Energy Efficiency: Commercial and Residential Buildings in Vorsatz et al., 1997.
- ATLAS, 2006. http://ec.europa.eu/comm/energy_transport/atlas/htmlu/lightdmarbarr.html
- Basu (2004), Supratim Basu, T.M.Undeland, PFC Strategies in light of EN 61000-3-2, EPE-PEMC 2004 Conference in Riga, LATVIA, 1- 3 September 2004.
- BNCL (2006), BNCL06: Performance Standards in Commercial Lighting - An overview (www.mtprog.com)
- Budde, 2007. Recent Advances in LED and OLED R&D and their Impact on Energy Saving, W. Budde, communication on ' International Workshop: Status, Prospects and Strategies for LEDs in General Lighting", Ispra, Italy, 3 & 4 May 2007.
- CELMA, 2005. Guide for the application of Directive 2000/55/EC on energy efficiency requirements for ballasts for fluorescent lighting. Issue 3, May 2005.
- Chang (1993), Chang, Y.N.; Moo, C.S.; Jeng, J.C, Harmonic analysis of fluorescent lamps with electromagnetic ballasts, IEEE Region 10 Conference Proceedings on Computer, Communication, Control and Power Engineering, 1993.
- CIE 102-1993: Recommended file format for electronic transfer of luminaire photometric data.
- CIE 117-1995: Discomfort glare in interior lighting.
- CIE 121-1996: The photometry and goniophotometry of luminaires.
- CIE 13.3-1995: Method of measuring and specifying colour rendering of light sources New edition (including Disk D008).
- CIE 158-2004: Ocular lighting effects on human physiology and behaviour.
- CIE 17.4-1987: International lighting vocabulary, 4th ed. (Joint publication IEC/CIE).
- CIE 19.21-1981: An analytic model for describing the influence of lighting parameters upon visual performance, 2nd ed., Vol.1.: Technical foundations.
- CIE 19.22-1981: An analytic model for describing the influence of lighting parameters upon visual performance, 2nd ed., Vol.2.: Summary and application guidelines.
- CIE 40-1978: Calculations for interior lighting: Basic method.
- CIE 52-1982: Calculations for interior lighting: Applied method.
- CIE 55-1983: Discomfort glare in the interior working environment.
- CIE 60-1984: Vision and the visual display unit work station.
- CIE 63-1984: The spectroradiometric measurement of light sources.
- CIE 69-1987: Methods of characterizing illuminance meters and luminance meters: Performance, characteristics and specifications.
- CIE 70-1987: The measurement of absolute luminous intensity distributions.
- CIE 77-1988: Electric light sources: State of the art – 1987.
- CIE 84-1989: Measurement of luminous flux.
- CIE 96-1992: Electric light sources - State of the art – 1991.
- CIE 97-2005 (2nd edition): Maintenance of indoor electric lighting systems

DEFU, 2001. Market research on the use of energy efficient lighting in the commercial sector. SAVE report.

DIN 5040-1(1976), Leuchten für Beleuchtungszwecke Teil 1: Lichttechnische Merkmale und Einteilung

DIN 5040-2 (1976): Leuchten für Beleuchtungszwecke Teil 2: Innenleuchten; Begriffe, Einteilung

Directive 2000/55/EC on energy efficiency requirements for ballasts for fluorescent lighting

Directive 2002/91/EC on the energy performance of buildings

Directive 2002/95/EC on Restriction of the use of certain Hazardous Substances in electrical and electronic equipment (RoHS)

Directive 2002/96/EC on waste electrical and electronic equipment (WEEE)

Directive 2004/108/EEC on Electromagnetic Compatibility (EMC)

Directive 2006/32/EC on energy end-use efficiency and energy services (repealing Council Directive 93/76/EEC)

Directive 73/23/EEC Low Voltage Directive (LVD)

Directive 98/11/EC of 27 January 1998 implementing Council Directive 92/75/EEC with regard to energy labelling of household lamps

Directive 98/11/EC on Energy labelling of household lamps

EC DG JRC, 2004b. Proceedings of workshop on “Electricity end-use in buildings: a survey of new Member States and Candidate Countries”

EC, DG JRC, 2004a. Energy end-use efficiency and electricity from biomass, wind and photovoltaics in the European Union. Status report 2004.

Ecofys, 2005. Cost-effective climate protection in the building stock of the new EU Member States: Beyond the EU Energy Performance of Buildings Directive. Report for EURIMA.

ELC (2007), Eco Profile 061106 CFL –Non Ballasted Single Capped Compact Fluorescent Lamps for General Lighting Applications

ELC (2007), Eco Profile 070516 FL –Linear Fluorescent Lamps for General Lighting Applications

EN 12464-1 (2004), Light and Lighting - Part1: Lighting of indoor work places

EN 12665 (2002), Light and lighting - Basic terms and criteria for specifying lighting requirements

EN 13032-1 (2004), Lighting applications — Measurement and presentation of photometric data of lamps and luminaires — Part 1: Measurement and file format

EN 13032-2 (2004), Light and lighting. Measurement and presentation of photometric data of lamps and luminaires. Part 2: Presentation of data for indoor and outdoor work places

EN 50294 , Measurement Method of Total Input Power of Ballast-Lamp Circuits

EN 60081 , Double-capped fluorescent lamps - Performance specifications

EN 60598-1 (2004), Luminaires - Part 1 : General requirements and tests

EN 60598-2 , Luminaires - Part 2: Particular requirements - Chapter 1: Fixed general purpose luminaires

EN 60598-2 , Luminaires - Part 2: Particular requirements - Chapter 2: Recessed luminaires

EN 60901 , Single-capped fluorescent lamps – Performance specifications

EN 60921 , Ballasts for tubular fluorescent lamps – Performance requirements

EN 60927 , Specification for auxiliaries for lamps. Starting devices (other than glow starters). Performance requirements

EN 60929 , AC-supplied electronic ballasts for tubular fluorescent lamps – Performance requirements

EN 61048 , Auxiliaries for Lamps - Capacitors for Use in Tubular Fluorescent and Other Discharge Lamp Circuits - General and Safety Requirements

EN 61049 , Capacitors for Use in Tubular Fluorescent and Other Discharge Lamp Circuits Performance Requirements

ENERDATA/FhG-ISI (2003) Energy efficiency in the European Union 1990-2001, SAVE-ODYSSEE Project on Energy Efficiency Indicators

Enertech, 2004. Technologies de l'information et d'éclairage: Enquêtes de terrain dans 50 bâtiments de bureaux.

Enertech, 2005. Technologies de l'information et d'éclairage: Campagne de mesures dans 49 ensembles de bureaux de la région PACA.

EPB Besluit (2005), Besluit Vlaamse Regering, dd. 16/12/2005, Eisen voor energieprestatie en binnenklimaat. . (www.energiesparen.be)

EPB Bijlage 2 (2005), Besluit Vlaamse Regering, dd. 16/12/2005, Eisen voor energieprestatie en binnenklimaat, Bijlage II. (www.energiesparen.be)

European CFL QUALITY CHARTER'

Eurostat (2003). Eurostat data shop Handbook part 6.4.2. Europroms-Prodcom data, version 29/08/2003.

Federaal Planbureau, 2006a. Het klimaatbeleid na 2012: Analyse van scenario's voor emissiereductie tegen 2020 en 2050.

Federaal Planbureau, 2006b. Economische perspectieven 2006-2011.

Fördergemeinschaft Gutes Licht, (). Heft 01 Die Beleuchtung mit künstlichem Licht, ISBN 3-926 193-01-8.

Fördergemeinschaft Gutes Licht, (). Heft 04 Gutes Licht für Büros und Verwaltungsgebäude, ISBN 3-926 193-04-02

Freedonia, 2004. World lighting fixtures to 2008. In IEA, 2006

Garcia, (2003), Single phase power factor correction: a survey, IEEE Transactions on Power Electronics, volume 18, issue 3, May 2003.

Härle, 2007. High brightness LEDs: On the move to 1000lm & next steps for solid state lighting, V. Härle, communication on ' International Workshop: Status, Prospects and Strategies for LEDs in General Lighting", Ispra, Italy, 3 & 4 May 2007.

http://epp.eurostat.ec.europa.eu/portal/page?_pageid=0,1136195,0_45572097&_dad=portal&_schema=PORTAL

http://www.celma.org/pdf_files/CELMA_Ballast_Guide_2005.pdf

IAEEL, 1994. International Association for Energy Efficient Lighting Newsletter, downloaded from http://www.iaeel.org/IAEEL/NEWSL/1994/fyra1994/LiMa_4_94.html

IDDRI, 2004. Carine Barbier, Richard Baron, Michel Colombier (Iddri), Catherine Boemare (Cired). Climate change policies, Analysis of sectoral changes in Europe (Paris)

IEA, 2006. Light's Labour's Lost: Policies for energy-efficient lighting.

IEC/TS 61231 , International lamp coding system (ILCOS)

IESNA, 1995. Lighting Handbook, Eighth Edition, ISBN 0-87995-102-8

Klinger, (2006), Ermittlung des Leuchtenbetriebswirkungsgrades mit einem neuartigen Digital-EVG als Referenz-Vorschaltgerät, Licht 2006, Bern, Communication.

LRC (1995), Robert Wolsey, Lighting Answers: Power Quality, National Lighting Product Information Program, volume 2, number 2, February 1995.

NEMA LE 5 (2001), Procedure for Determining Luminaire Efficacy Ratings for Fluorescent Luminaires

Neufert, 2000. Architects'data, Third Edition, ISBN 0-632-05771-8.

Novem, 1999. Study on European Green Light: Saving potential and best practices in lighting applications and voluntary programmes. SAVE report

NYFER, 2001. Kijk op kantoren: Ontwikkeling van de regionale kantorenmarkten in Nederland.

Philips (Berno Ram) in Van de Wiel, H., 2006

prEN 15193 (2006), Energy performance of buildings - Energy requirements for lighting

Prodcom query from Eurostat website

RICS, 2005. RICS Office property market: German demographic trends and the property market Downloaded from <http://www.rics.org/Property/Commercialproperty/Officeproperty/Officepropertymarket/German%20demographic%20trends%20and%20the%20office%20market.html>, March 2005

Roisin, 2007, Optimising and control of energy lighting consumption in offices, communication on ' IEA-ECBCS Annex 45 Energy Efficient Electric Lighting for Buildings, E3 Light 5th Expert Meeting, 18-20 April 2007, Brussels, Belgium.

SenterNovem (2004). Energiebesparingsmonitor in de gebouwde omgeving. Rapportage EBM 2003.

SN 520 380/4 (2006), Elektrische Energie im Hochbau

Steele, 2007. The Market Outlook for High-Brightness LEDs in Lighting Applications International, R. Steele, , communication on ' International Workshop: Status, Prospects and Strategies for LEDs in General Lighting", Ispra, Italy, 3 & 4 May 2007.

Swiss Centre for Life Cycle Inventories: ECOINVENT database

Topalis (1993), Efficiency of energy saving lamps and harmonic distortion in distribution systems, IEEE Transactions on Power Delivery, volume 8, issue 4, October 1993.

United Nations Economic Commission for Europe, 2002. Environment and Human Settlements Division database on housing and building – last updated on 30/08/2006

Van de Wiel, H., 2006. Oude energievreters. Artikel in Milieu Magazine nr 5-6, jaargang 17.

VHK, 2005. MEEUP Methodology Report

VITO et al. (2007), Preparatory Studies for Eco-design Requirements of EuPs, Final Report Lot 9: Public street lighting

Vorsatz et al., 1997. Lighting market sourcebook for the US.

WTCB, W&K, Cenergie en Universiteit Gent, 2002. Kantoor 2000: Studie van energiegebruik en binnenklimaat van kantoren. Vliet-bis project.

Xenergy Inc., 2000. Commercial and industrial lighting study, Volume 1: Market research report.

ZVEI, (2005), Leitfaden zur DIN EN 12464-1: Beleuchtung von Arbeitsstätten – Teil 1: Arbeitsstätten in Innenräumen.

ZVEI, (2005), Life behaviour of discharge lamps for general lighting.

10 ABBREVIATIONS AND ACRONYMS

Abbreviation / Acronym	Full text	Defined in
BAT	Best Available Technology	MEEuP
BAU	Business-As-Usual	MEEuP
BFR	Ballast Failure Rate	
BGF	Ballast Gain Factor	
BMF	Ballast Maintenance Factor	
BNAT	Best Not yet Available Technology	MEEuP
BOM	Bill Of Materials	MEEuP
BS xxxxx	Prefix for a British Standard	
cd	candela (unit for light intensity)	
cd / m ²	candela per square meter (unit for luminance)	
CELMA	Federation of National Manufacturers Associations for Luminaires and Electrotechnical Components for Luminaires in the European Union	
CEN	Comité Européen de Normalisation European Committee for Standardization	
CEN/TR	CEN Technical Report (no standard)	
CENELEC	Comité Européen de Normalisation Electrotechnique European Committee for Electrotechnical Standardization	
CFL	Compact Fluorescent Lamp	
CFL-i	Compact Fluorescent Lamp with integrated ballast	
CFL-ni	Compact Fluorescent Lamp non integrated ballast	
CIE	Commission Internationale de l'Eclairage International Commission on Illumination	
CMH	Ceramic Metal Halide	

CN	Combined Nomenclature	1.1.2.1
CRI	Colour Rendering Index (see also Ra)	
DFF	Downward Flux Fraction	1.1.4.1
DG TREN	Directorat General for Transport and Energy	
DIY	Do It Yourself (shop)	
DLOR	Downward Light Output Ratio	
E	Illuminance [lx]	
E_{avg}	Average illuminance [lx]	
EC	European Commission	
EEI	Energy Efficiency Index	
ELC	European Lamp Companies Federation	
EMC	ElectroMagnetic Compatibility	
E_{min}	minimum illuminance	
EN xxxxx	Prefix for a European Standard	
EOL	End Of Life	MEEuP
EPB	Energy Performance of Buildings	1.3.1.3
EU25	The European Union of the 25 member countries	
EuP	Energy using Product	
FL	Fluorescent Lamp	
FU	Functional Unit	
GER	Gross Energy Requirements	MEEuP
HE	High Efficiency (for T5 LFL)	
HO	High Output (for T5 LFL)	
IEA	International Energy Agency	
IEC	International Electrotechnical Committee	

IEE	Intelligent Energy for Europe	
IESNA	Illuminating Engineering Society of North America	
ILCOS	International Lamp CODing System	
IP (rating)	Ingress Protection	
ISO	International Standards Organisation	
L	Luminance [cd/m ²]	
LCA	Life Cycle Assessment	MEEuP
LCC	Life-Cycle Cost	MEEuP
LED	Light Emitting Diode	
LER	Luminaire Efficacy Rating	1.1.4.1
LERc	Luminaire Efficacy Rating corrected	1.1.4.1
LFL	Linear Fluorescent Lamp	1.1.6
LGF	Lamp Gain Factor	
LLCC	Least Life-Cycle Cost	MEEuP
LLMF	Lamp Lumen Maintenance Factor	
LMF	Luminaire Maintenance Factor	
LOR	Light Output Ratio	
LPD	Lighting Power Density	
LSF	Lamp Survival Factor	
LVD	Low Voltage Directive	
lx	lux (unit for illumination)	
MEEUP	Methodology study for Ecodesign of Energy-using Products	
MEPS	Minimum Energy Performance Standard	
Mtoe	Megaton oil equivalent	
NA	Not Applicable	

OEM	Original Equipment (luminaire) Manufacturer	
OLED	Organic Light Emitting Diode	
PAH	Polycyclic Aromatic Hydrocarbons	MEEuP
PJ	PetaJoule = 10^{15} Joule	
P_{lamp}	Lamp power [W]	
PM	Particulate Matter	MEEuP
POP	Persistent Organic Pollutants	MEEuP
P_{real}	Real power consumption of a luminaire	
Ra	Colour rendering index (see also CRI)	
RoHS	Restriction of the use of certain Hazardous Substances	
ROI	Return On Investment	
RSMF	Room Surface Maintenance Factor	3.2.2
SME	Small and Medium-sized Enterprises	
SSL	Solid State Lighting (LED)	
TC 169/226 JWG	Technical Commission 169/229 Joint Working Group (Lighting) in CEN	
t_{group}	time period for group replacement (of lamps)	
TI	Threshold Increment	
U	Utilance (of an installation)	
UF	Utilization Factor	
UFF	Upward Flux Fraction	1.1.4.1
UFr	Utilization Factor real	
ULOR	Upward Light Output Ratio	
VHK	Van Holsteijn en Kemna BV	
VOC	Volatile Organic Compounds	MEEuP
WC	Worst Case	

WEEE	Waste of Electrical and Electronic Equipment	
WLED	White LED	
η_{ballast}	Ballast efficiency	
η_{lamp}	Luminous efficacy of a lamp [lm/W]	
Φ	(luminous) Flux [lm]	

ANNEX A: PRODCOM CATEGORIES OF RELEVANT LIGHTING PARTS APPLICABLE IN OFFICE LIGHTING

The for this office lighting study defined relevant 'lamps' are included in the following two Prodcum categories (Table 118). Please note that these lamps are also used in other applications.

Table 118: Two most relevant lamp types applicable for office lighting

PRODUCT GROUP	PRODCOM	DESCRIPTION
lamp type	31501510	Fluorescent hot cathode discharge lamps, with double ended cap (excluding ultraviolet lamps)
lamp type	31501530	Fluorescent hot cathode discharge lamps (excluding ultraviolet lamps, with double ended cap)

Table 119 contains the Prodcum control gear categories. The two most relevant categories for defined “office lighting ballasts” are: “Inductors for discharge lamps or tubes” or ferromagnetic ballasts; and “Ballasts for discharge lamps or tubes (excluding inductors)” or electronic ballasts. Please note that these ballasts are also used with other lamp types and in other applications.

Table 119: Ballast and ballast parts

PRODUCT GROUP	PRODCOM	DESCRIPTION
lamp parts	31105013	Inductors for discharge lamps or tubes
lamp parts	31105015	Ballasts for discharge lamps or tubes (excluding inductors)
lamp parts	31504250	Parts (excluding of glass or plastics) of lamps and lighting fittings, etc.

For the analysis we will use a more refined product segmentation according to the classification system developed by CELMA (which is compliant with the Ballast Directive) In this system ballasts are classified according to their Energy Efficiency Index (EEI)⁶⁷. The grading consists of 7 classes of efficiency defined by a limiting value of total input power related to the corresponding ballast lumen factor (BLF). These classes have no direct correlation to a specific technology. The label on the product will indicate the class defined through the Energy Efficiency Index. The classes are A1, A2, A3, B1, B2, C and D (See paragraph 1.1.5).

For the purpose of this study these CELMA ballast classes will be further segmented according to the complementary dimming control system and/or presence detection control system when incorporated in the luminaire (See § 1.1.5).

⁶⁷ The “Energy Efficiency Index” (EEI) of the ballast-lamp combination is defined as the corrected total input power of the lamp-ballast circuit.

In Eurostat’s product-specific statistics for trade and production (the so-called Europroms⁶⁸-Prodcom⁶⁹ statistics) office lighting luminaires can be reported in two manners:

1. According to lamp technology
2. According to the material from of which the luminaires are made.

For office lighting luminaires, Prodcom distinguishes under heading 31.50.25 “Chandeliers and other electric ceiling or wall lighting lamps” 4 types of office lighting luminaires according to lamp type (Table 120).

Table 120 : Office lighting luminaires categories

PRODUCT GROUP	PRODCOM	DESCRIPTION
Office lighting	31502563	Office lighting (task lighting): for incandescent lamps
Office lighting	31502565	Office lighting (task lighting): for compact fluorescent lamps
Office lighting	31502567	Office lighting (task lighting): for other fluorescent lamps
Office lighting	31502569	Office lighting (task lighting): for other lamps

Besides these relevant categories, enquiry of the lighting industry (ETAP, pers. Comm. of L. Truyen on 08/09/2006) revealed that the Prodcom heading 31.50.34.30 “Electric lamps and lighting fittings, of plastic and other materials, of a kind used for filament lamps and tubular fluorescent lamps” is also relevant for this study (See paragraph 1.1.2.1).

⁶⁸ Europroms is the name given to published Prodcom data. It differs from Prodcom in that it combines production data from Prodcom with import and export data from the Foreign Trade database.

⁶⁹ Prodcom originates from the French “PRODUCTION COMMUNAUTAIRE”

ANNEX B: EUROPROMS RESULTS FOR THE TWO MOST RELEVANT LAMP TYPES APPLICABLE IN OFFICE LIGHTING

Remark regarding the availability of data

According to the Eurostat data shop Handbook (part 6.4.2. Europroms-Prodcom data, version 29/08/2003) there are two reasons why expected data might not be found in Europroms:

- The data is confidential. This is indicated by (1) in the following tables.

If only a small number of enterprises produce a product in the reporting country, there is a risk that information regarding an individual enterprise might be revealed. If the enterprise does not agree to this the reporting country declares the production figures confidential. They are transmitted to Eurostat but not published. However if several countries declare their production for a heading to be confidential, an EU total can be published because the data for an individual country cannot be inferred.

- The data is missing. This is indicated as ‘-’ in the following tables.

There are a number of reasons why data might be missing: the reporting country does not survey the heading; the reporting country has reason to doubt the accuracy of the data and suppresses it; or the reporting country uses the wrong volume unit or the wrong production type, which means that the data is not comparable with other countries and is suppressed by Eurostat.

If data is missing for one or more Member States the corresponding EU total cannot be calculated and is also marked as missing.

Table 121: Fluorescent hot cathode discharge lamps, with double ended cap (excluding ultraviolet lamps): Europroms results

Year	Region	Production		Imports		Exports		Apparent consumption	
		Volume (Unit)	Value (Euro)	Volume	Value	Volume	Value	Volume (Unit)	Value (Euro)
1995	EU-15	-	-	35.499.391	33.613.480	84.309.412	64.049.380	-	-
2000	EU-15	-	392.905.940	58.594.285	49.459.660	65.388.744	74.478.450	-	367.887.150
2001	EU-15	417.402.169 (2)	456.910.317	63.627.007	57.261.540	77.804.599	71.625.520	403.224.577	442.546.337
2002	EU-15	384.928.874 (2)	430.431.029	57.526.654	51.399.280	88.768.820	72.442.220	353.686.708	409.388.089
2003	EU-15	(1)	(1)	77.570.470	65.283.680	178.684.941	72.359.410	-	-
2003	EU-25	447.475.713 (2)	440.158.829 (2)	116.254.466	83.489.024	296.927.308	124.933.837	266.802.871	398.714.016
2004	EU-15	(1)	(1)	87.508.252	61.858.890	207.383.653	117.288.650	-	-
2004	EU-25	443.176.926	433.341.545	119.260.965	75.769.736	252.438.197	137.006.112	309.999.694	372.105.169

Table 122: Fluorescent hot cathode discharge lamps (excluding ultraviolet lamps, with double ended cap): Europroms results

Year	Region	Production		Imports		Exports		Apparent consumption (calculated)	
		Volume (Unit)	Value (Euro)	Volume (Unit)	Value (Euro)	Volume (Unit)	Value (Euro)	Volume (Unit)	Value (Euro)
1995	EU-15	-	-	62.323.576	99.696.890	25.556.790	72.634.460	-	-
2000	EU-15	-	231.075.692	219.537.412	248.364.380	38.704.621	73.368.010	-	406.072.062
2001	EU-15	90.387.134 (2)	241.696.472	176.773.359	244.993.840	38.002.872	61.090.760	229.157.621	425.599.552
2002	EU-15	91.283.564 (2)	238.391.908	193.172.037	237.399.460	39.204.326	59.676.730	245.251.275	416.114.638
2003	EU-15	(1)	(1)	204.509.443	239.160.840	55.158.828	104.458.840	-	-
2003	EU-25	98.710.007	269.028.401	245.452.416	270.925.972	79.282.263	149.058.218	264.880.160	390.896.155
2004	EU-15	(1)	(1)	198.971.818	286.211.330	66.283.486	125.406.810	-	-
2004	EU-25	101.143.024	266.291.528	251.652.273	323.730.412	76.434.650	141.599.010	276.360.647	448.422.930

ANNEX C: OVERVIEW OF PRODUCTION, TRADE AND CONSUMPTION DATA FOR LAMP TYPES APPLICABLE IN OFFICE LIGHTING

Table 123: Overview of 'Fluorescent hot cathode discharge lamps, with double ended cap (excluding ultraviolet lamps)' production, trade and consumption data: 2001-2004 (Source: Europroms)

		2001	2002	2003	2003	2004	2004
VALUE (1000 Euro)	Remark	EU-15	EU-15	EU-15	EU-25	EU-15	EU-25
EU Manufacturer sales	This corresponds to Europroms "Production"	456.910	430.431	(1)	440.159	(1)	433.342
Total (extra EU-25) Imports		57.262	51.399	65.284	83.489	61.859	75.770
Total (extra EU-25) Exports		71.626	72.442	72.359	124.934	117.289	137.006
Net Balance	= Total Imports – Total Exports	-14.364	-21.043	-7.075	-41.445	-55.430	-61.236
EU Net supply	This corresponds to Europroms 'Apparent consumption'	442.546-	409.388	-	398.714	-	372.106-
Export as % of EU Manufacturer sales	Export as % of production						
EU Manufacturer sales		100	100	(1)	100	(1)	100
Total (extra EU-25) Exports	Sales on a foreign market	15,7	16,8	-	28,4	-	31,6
EU Sales	Sales on the EU-25 market	84,3	83,2	-	71,6	-	68,4
Import as % of EU Net supply	Import as % of Apparent consumption						
EU Net supply		100	100	-	100	-	100
Total (extra EU-25) Imports		12,9	12,6	-	20,9	-	20,4
EU production		87,1	87,4	-	79,1	-	79,6

Table 124: Overview of 'Fluorescent hot cathode discharge lamps (excluding ultraviolet lamps, with double ended cap)' production, trade and consumption data: 2001-2004 (Source: Europroms)

		2001	2002	2003	2003	2004	2004
VALUE (1000 Euro)	Remark	EU-15	EU-15	EU-15	EU-25	EU-15	EU-25
EU Manufacturer sales	This corresponds to Europroms "Production"	241.696	238.392	(1)	269.028	(1)	266.292
Total (extra EU-25) Imports		244.994	237.399	239.161	270.926	286.211	323.730
Total (extra EU-25) Exports		61.091	59.677	104.459	149.058	125.407	141.599
Net Balance	= Total Imports – Total Exports	183.903	177.722	134.702	121.868	160.804	182.131
EU Net supply	This corresponds to Europroms 'Apparent consumption' <i>EU Manufacturer sales + Imports – Exports</i>	425.599	416.114	-	390.896	-	448.423
Export as % of EU Manufacturer sales	Export as % of production						
EU Manufacturer sales		100	100	(1)	100	(1)	100
Total (extra EU-25) Exports	Sales on a foreign market	25,3	25,0	-	55,4	-	53,2
EU Sales	Sales on the EU-25 market	74,7	75,0	-	44,6	-	46,8
Import as % of EU Net supply	Import as % of Apparent consumption						
EU Net supply		100	100	-	100	-	100
Total (extra EU-25) Imports		57,6	57,0	-	69,3	-	72,2
EU production		42,4	43,0	-	30,7	-	27,8

ANNEX D: EUROPROMS RESULTS FOR BALLAST AND BALLAST PARTS APPLICABLE IN OFFICE LIGHTING

Table 125: Inductors for discharge lamps or tubes: Europroms results

Yea	Region	Production			Imports			Exports			Apparent consumption (calculated)		
		Volume	Value	Price per item (calculated)	Volume	Value	Price per item (calculated)	Volume	Value	Price per item (calculated)	Volume	Value	Price per item (calculated)
		(Unit)	(Euro)	(Euro per item)	(Unit)	(Euro)	(Euro per item)	(Unit)	(Euro)	(Euro per item)	(Unit)	(Euro)	(Euro per item)
1995	EU-15	-	-	-	18.329.283	6.376.630	0,3	40.369.012	82.063.690	2,0	-	-	-
2000	EU-15	-	-	-	50.092.153	32.781.20	0,7	105.666.50	43.175.779	0,4	-	-	-
2001	EU-15	228.827.67	446.473.00	2,0	24.765.054	35.158.43	1,4	54.726.648	143.705.68	2,6	198.866.07	337.925.75	1,7
2002	EU-15	232.313.43	432.665.38	1,9	16.026.270	41.599.01	2,6	59.894.676	112.040.38	1,9	188.445.02	362.224.01	1,9
2003	EU-15	(1)	(1)	-	19.242.992	49.845.89	2,6	53.890.048	124.656.66	2,3	-	-	-
2003	EU-25	498.360.54	379.028.14	0,8	136.068.03	70.062.62	0,5	68.408.689	136.498.58	2,0	566.019.89	312.592.18	0,6
2004	EU-15	(1)	(1)	-	62.718.631	59.870.96	1,0	60.386.997	147.863.60	2,5	-	-	-
2004	EU-25	591.918.05	342.501.77	0,6	126.957.81	69.681.80	0,5	69.039.908	154.293.91	2,2	649.835.95	257.889.65	0,4

Table 126: Ballasts for discharge lamps or tubes (excluding inductors): Europroms results

Yea	Region	Production			Imports			Exports			Apparent consumption (calculated)		
		Volume	Value	Price per item	Volume	Value	Price per item	Volume	Value	Price per item	Volume	Value	Price per item
		(Unit)	(Euro)	(Euro per item)	(Unit)	(Euro)	(Euro per item)	(Unit)	(Euro)	(Euro per item)	(Unit)	(Euro)	(Euro per item)
1995	EU-15	-	-	-	37.576.73	27.561.130	0,7	12.858.90	39.174.160	3,0	-	-	-
2000	EU-15	-	-	-	23.320.60	137.019.27	5,9	33.421.76	162.134.12	4,9	-	-	-
2001	EU-15	110.223.18	306.612.25	2,8	26.437.32	162.667.85	6,2	29.929.94	154.265.58	5,2	106.730.56	315.014.52	3,0
2002	EU-15	134.301.81	294.796.26	2,2	35.382.09	188.806.21	5,3	43.998.57	189.165.39	4,3	125.685.33	294.437.08	2,3
2003	EU-15	(1)	282.808.30	-	43.491.97	216.005.03	5,0	34.170.16	211.295.50	6,2	-	287.517.83	-
2003	EU-25	65.935.720	291.642.19	4,4	72.978.43	240.527.04	3,3	35.462.99	214.313.34	6,0	103.451.16	317.855.89	3,1
2004	EU-15	56.209.323	362.281.76	6,4	60.393.77	233.184.99	3,9	35.590.16	226.867.17	6,4	81.012.933	368.599.58	4,5
2004	EU-25	63.336.031	370.751.34	5,9	85.730.63	246.020.72	2,9	36.632.81	228.751.21	6,2	112.433.85	388.020.85	3,5

ANNEX E: OVERVIEW OF PRODUCTION, TRADE AND CONSUMPTION DATA FOR BALLAST AND BALLAST PARTS APPLICABLE IN OFFICE LIGHTING

*Table 127: Overview of 'Inductors for discharge lamps or tubes-ferromagnetic ballasts' production, trade and consumption data, 2001-2004
(Source: Europroms)*

		2001	2002	2003	2003	2004	2004
VALUE (1000 Euro)	Remark	EU-15	EU-15	EU-15	EU-25	EU-15	EU-25
EU Manufacturer sales	This corresponds to Europroms "Production"	446.473	432.665	(1)	379.028	(1)	342.502
Total (extra EU-25) Imports		35.158	41.599	49.846	70.063	59.871	69.682
Total (extra EU-25) Exports		143.706	112.040	124.657	136.499	147.864	154.294
Net Balance	= Total Imports – Total Exports	-108.548	-70.441	-74.811	-66.436	-87.993	-84.612
EU Net supply	This corresponds to Europroms 'Apparent consumption' = EU Manufacturer sales + Imports – Exports	337.926	362.224	-	312.592	-	257.890
Export as % of EU Manufacturer sales	Export as % of production						
EU Manufacturer sales		100	100	(1)	100	(1)	100
Total (extra EU-25) Exports	Sales on a foreign market	32,2	25,9	-	36,0	-	45,0
EU Sales	Sales on the EU-25 market	67,8	74,1	-	64,0	-	55,0
Import as % of EU Net supply	Import as % of Apparent consumption						
EU Net supply		100	100	-	100	-	100
Total (extra EU-25) Imports		10,4	11,5	-	22,4	-	27,0
EU production		89,6	88,5	-	77,6	-	73,0

Table 128: Overview of 'Ballasts for discharge lamps or tubes (excluding inductors)-electronic ballasts' production, trade and consumption data, 2001-2004 (Source: Europroms)

		2001	2002	2003	2003	2004	2004
VALUE (1000 Euro)	Remark	EU-15	EU-15	EU-15	EU-25	EU-15	EU-25
EU Manufacturer sales	This corresponds to Europroms "Production"	306.612	294.796	282.808	291.642	362.282	370.751
Total (extra EU-25) Imports		162.668	188.806	216.005	240.527	233.185	246.021
Total (extra EU-25) Exports		154.266	189.165	211.295	214.313	226.867	228.751
Net Balance	= Total Imports – Total Exports	8.402	-359	4.710	26.214	6.318	17.270
EU Net supply	This corresponds to Europroms 'Apparent consumption' = EU Manufacturer sales + Imports - Exports	315.014	294.437	287.518	317.856	368.600	388.021
Export as % of EU Manufacturer sales	Export as % of production						
EU Manufacturer sales		100	100	100	100	100	100
Total (extra EU-25) Exports	Sales on a foreign market	50,3	64,2	74,7	73,5	62,6	61,7
EU Sales	Sales on the EU-25 market	49,7	35,8	25,3	26,5	37,4	38,3
Import as % of EU Net supply	Import as % of Apparent consumption						
EU Net supply		100	100	100	100	100	100
Total (extra EU-25) Imports		51,6	64,1	75,1	75,7	63,3	63,4
EU production		48,4	35,9	24,9	24,3	36,7	36,6

ANNEX F: EUROPROMS RESULTS FOR CATEGORIES OF LUMINAIRES IN OFFICE LIGHTING

Table 129: Office lighting (task lighting): for incandescent lamps : Europroms results

	Production (volume)				Production (value)			
	1995	2000	2001	2002	1995	2000	2001	2002
France	(2)	(1)	(1)	161.615	5.755.927	(1)	5.133.000	10.241.000
Netherlands	(1)	0	0	0	(1)	0	0	0
Germany	(2)	(2)	(2)	451.866	(2)	(2)	(2)	12.519.000
Italy	626.306	(2)	(2)	(2)	2.671.186	(2)	(2)	(2)
United Kingdom	(2)	(2)	(2)	(2)	(2)	(2)	(2)	(2)
Ireland	0	0	0	0	0	0	0	0
Denmark	0	0	0	0	0	0	0	0
Greece	(2)	(2)	(2)	(2)	(2)	(2)	(2)	(2)
Portugal	(1)	(1)	(1)	(1)	(1)	(1)	(1)	(1)
Spain	(2)	(2)	(2)	(2)	(2)	(2)	(2)	(2)
Belgium	(2)	(2)	(2)	(2)	(2)	(2)	(2)	(2)
Luxemburg	0	0	0	0	0	0	0	0
Sweden	(2)	(2)	(2)	(2)	(2)	(2)	(2)	(2)
Finland	(2)	1.768	1.715	1.545	(2)	55.334	53.820	47.883
Austria	(2)	(2)	(2)	(2)	(2)	(2)	(2)	(2)
Malta								
Estonia		0	0	0		0	0	0
Latvia			0	0			0	0
Lituania		(2)	0	0		(2)	0	0
Poland				(2)				(2)
Czech Republic			(2)	(2)			(2)	(2)
Slovakia		(2)	(2)	0		(2)	(2)	0
Hungary			0	0			0	0

Slovenia			0	0			0	0
Cyprus								
EU15TOTALS	(1)	(1)	(1)	(1)	(1)	(1)	(1)	(1)
EU25TOTALS								

Table 130: Office lighting (task lighting): for compact fluorescent lamps : Europroms results

	Production (volume)				Production (value)			
	1995	2000	2001	2002	1995	2000	2001	2002
France	(2)	(2)	144.62	204.749	5.287.275	10.727.178	13.722.000	14.501.000
Netherlands	(1)	0	0	0	(1)	0	0	0
Germany	(2)	(2)	(2)	732.859	(2)	(2)	(2)	44.144.000
Italy	307.588	(2)	(2)	(2)	8.600.843	(2)	(2)	(2)
United Kingdom	(2)	(2)	(2)	(2)	(2)	(2)	(2)	(2)
Ireland	0	0	0	0	0	0	0	0
Denmark	0	0	0	0	0	0	0	0
Greece	(2)	(2)	(2)	(2)	(2)	(2)	(2)	(2)
Portugal	35.634	84.237	62.378	56.845	699.365	2.068.041	1.528.313	1.270.515
Spain	(2)	(2)	(2)	(2)	(2)	(2)	(2)	(2)
Belgium	(2)	(2)	(2)	(2)	(2)	(2)	(2)	(2)
Luxemburg	0	0	0	0	0	0	0	0
Sweden	(2)	(2)	(2)	(2)	(2)	(2)	(2)	(2)
Finland	(2)	344.714	345.232	333.560	(2)	17.509.797	18.856.556	17.403.971
Austria	(2)	(2)	(2)	(2)	(2)	(2)	(2)	(2)
Malta								
Estonia		0	0	0		0	0	0
Latvia			0	0			0	0
Lituania		(2)	0	0		(2)	0	0
Poland				(2)				(2)
Czech Republic			(2)	(2)			(2)	(2)
Slovakia		(2)	(2)	0		(2)	(2)	0
Hungary			0	0			0	0
Slovenia			0	0			0	0
Cyprus								
EU15TOTALS	(1)	2.897.468 ⁽³⁾	551.772 ⁽³⁾	1.328.013 ⁽³⁾	(1)	56.667.559 ⁽³⁾	34.106.869 ⁽³⁾	77.319.486 ⁽³⁾
EU25TOTALS								

Table 131: Office lighting (task lighting): for other fluorescent lamps : Europroms results

	Production (volume)				Production (value)			
	1995	2000	2001	2002	1995	2000	2001	2002
France	(2)	(2)	1.136.771	1.588.695	68.638.642	102.063.083	67.800.000	71.465.000
Netherlands	(1)	0	0	0	(1)	0	0	0
Germany	(2)	(2)	(2)	3.535.824	(2)	(2)	(2)	257.500.000
Italy	2.498.064	(2)	(2)	(2)	27.378.013	(2)	(2)	(2)
United Kingdom	(2)	(2)	(2)	(2)	(2)	(2)	(2)	(2)
Ireland	0	0	0	0	0	0	0	0
Denmark	0	0	0	0	0	0	0	0
Greece	(2)	(2)	(2)	(2)	(2)	(2)	(2)	(2)
Portugal	400.126	966.357	850.674	755.591	7.613.126	14.654.458	13.700.389	12.656.539
Spain	(2)	(2)	(2)	(2)	(2)	(2)	(2)	(2)
Belgium	(2)	(2)	(2)	(2)	(2)	(2)	(2)	(2)
Luxemburg	0	0	0	0	0	0	0	0
Sweden	(2)	(2)	(2)	(2)	(2)	(2)	(2)	(2)
Finland	(2)	229.456	121.277	1.056	(2)	6.859.243	3.690.716	126.720
Austria	(2)	(2)	(2)	(2)	(2)	(2)	(2)	(2)
Malta								
Estonia		0	0	0		0	0	0
Latvia			(1)	(1)			(1)	(1)
Lituania		(2)	0	0		(2)	0	0
Poland				(2)				(2)
Czech Republic			(2)	(2)			(2)	(2)
Slovakia		(2)	(2)	0		(2)	(2)	0
Hungary			0	0			0	0
Slovenia			(1)	(1)			(1)	(1)
Cyprus								
EU15TOTALS	(1)	17.421.169 ⁽³⁾	2.108.722 ⁽³⁾	5.881.166 ⁽³⁾	(1)	251.838.855 ⁽³⁾	85.191.105 ⁽³⁾	341.748.259 ⁽³⁾
EU25TOTALS								

Table 132: Office lighting (task lighting): for other lamps : Europroms results

	Production (volume)				Production (value)			
	1995	2000	2001	2002	1995	2000	2001	2002
France	(1)	(1)	(1)	0	(1)	(1)	(1)	0
Netherlands	(1)	0	0	0	(1)	0	0	0
Germany	(2)	(2)	(2)	451.866	(2)	(2)	(2)	12.519.000
Italy	603.110	(2)	(2)	(2)	8.174.111	(2)	(2)	(2)
United Kingdom	(2)	(2)	(2)	(2)	(2)	(2)	(2)	(2)
Ireland	0	0	0	0	0	0	0	0
Denmark	0	0	0	0	0	0	0	0
Greece	(2)	(2)	(2)	(2)	(2)	(2)	(2)	(2)
Portugal	(1)	(1)	(1)	(1)	(1)	(1)	(1)	(1)
Spain	(2)	(2)	(2)	(2)	(2)	(2)	(2)	(2)
Belgium	(2)	(2)	(2)	(2)	(2)	(2)	(2)	(2)
Luxemburg	0	0	0	0	0	0	0	0
Sweden	(2)	(2)	(2)	(2)	(2)	(2)	(2)	(2)
Finland	(2)	2.849	2.764	2.454	(2)	104.950	102.090	90.807
Austria	(2)	(2)	(2)	(2)	(2)	(2)	(2)	(2)
Malta								
Estonia		0	0	0		0	0	0
Latvia			0	0			0	0
Lituania		(2)	0	0		(2)	0	0
Poland				(2)				(2)
Czech Republic			(2)	(2)			(2)	(2)
Slovakia		(2)	(2)	0		(2)	(2)	0
Hungary			0	0			0	0
Slovenia			0	0			0	0
Cyprus								
EU15TOTALS	962.485 ⁽³⁾	(1)	(1)	(1)	10.313.148 ⁽³⁾	(1)	(1)	(1)
EU25TOTALS								

ANNEX G: OVERVIEW OF LAMP AND BALLAST PRODUCTION, TRADE AND CONSUMPTION IN EU-25 IN 2004

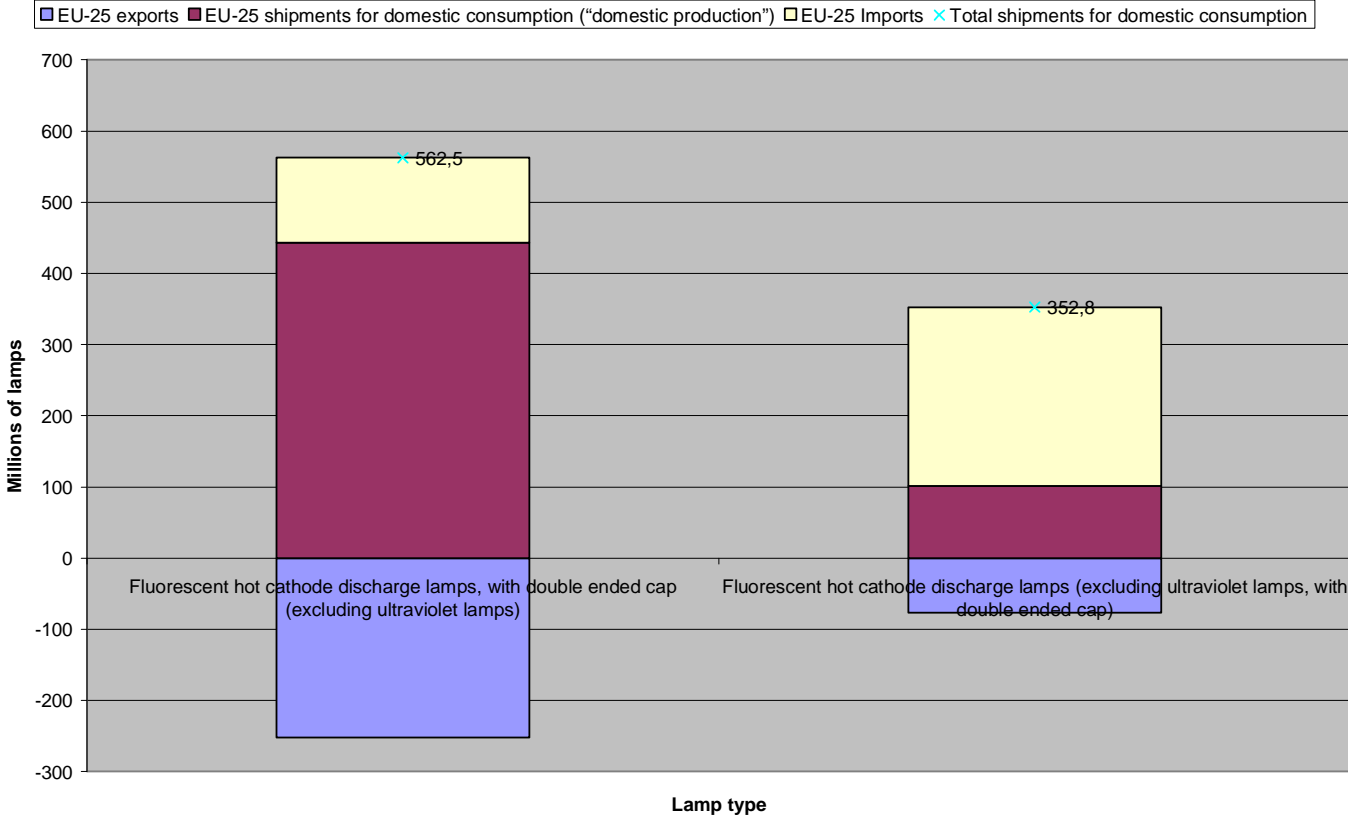

Figure 66: Lamp production, trade and consumption volume in EU-25, 2004

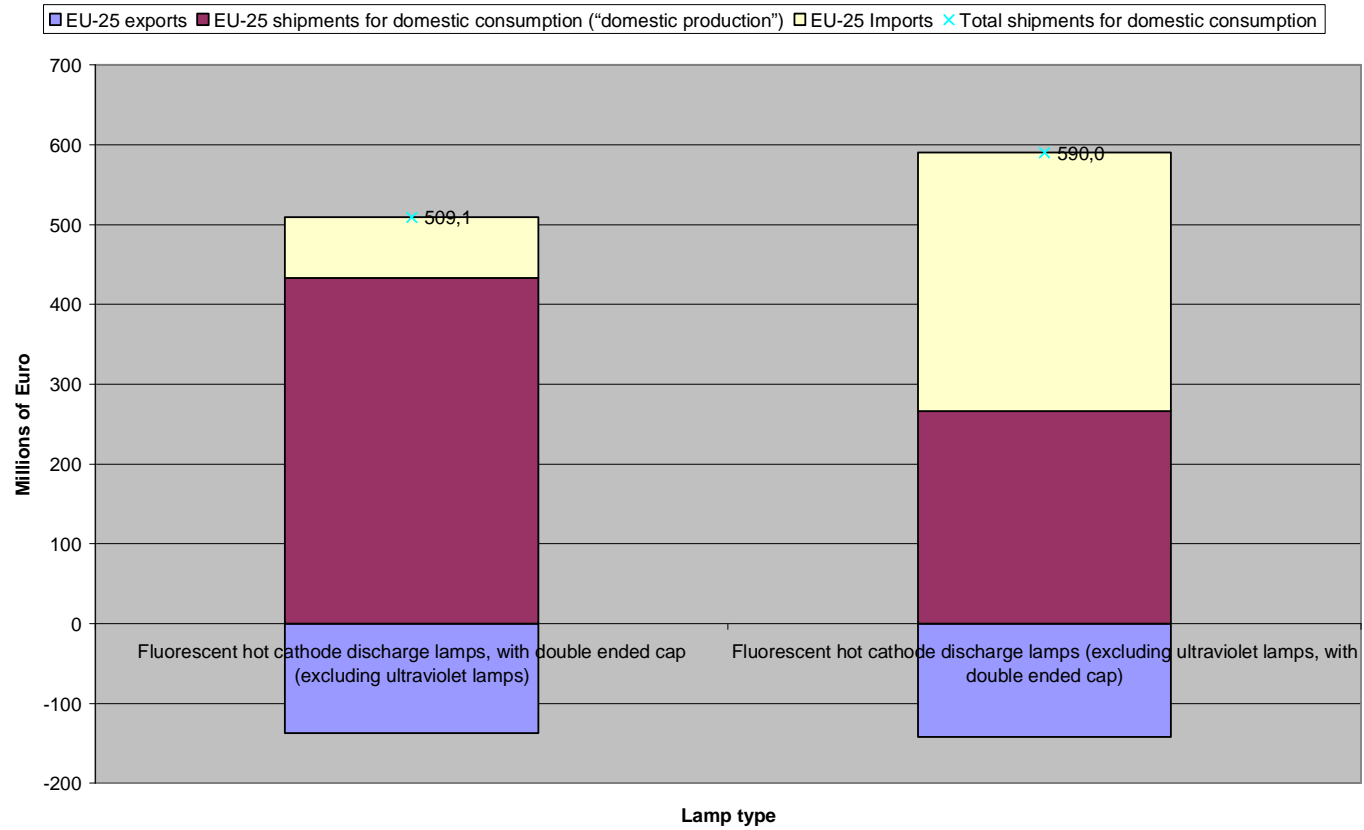

Figure 67: Value of lamp production, trade and consumption in EU-25, 2004

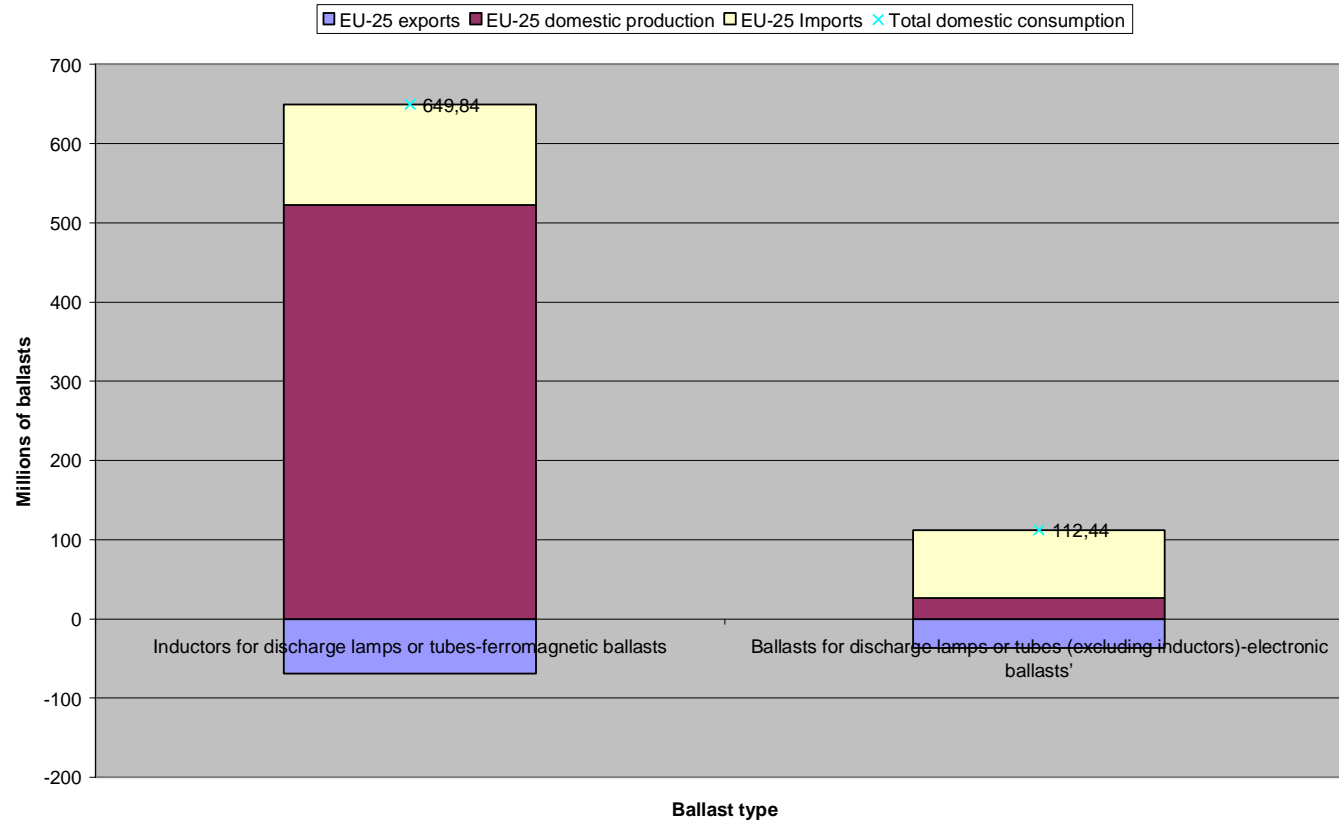

Figure 68: Ballast production, trade and consumption volume in EU-25, 2004

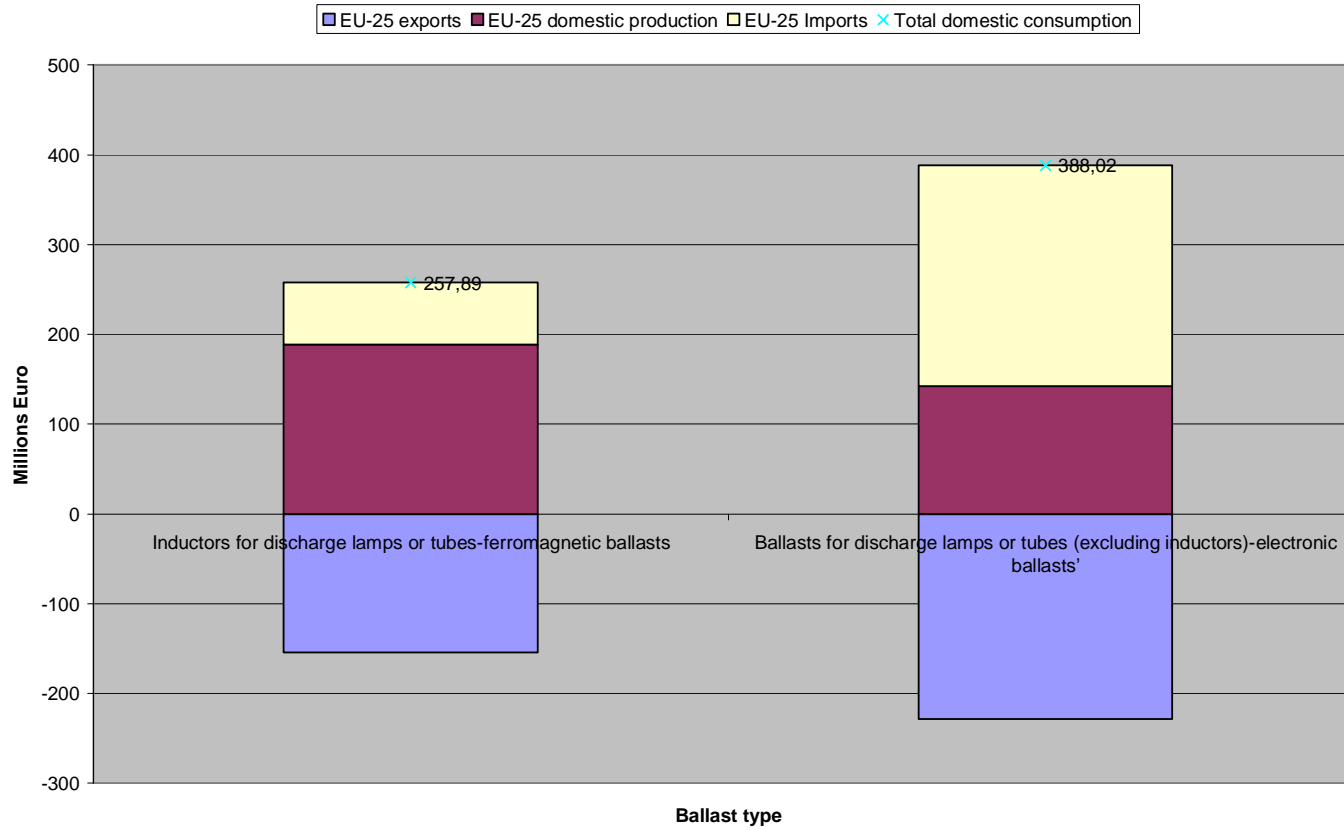

Figure 69: Value of ballast production, trade and consumption in EU-25, 2004

ANNEX H: EU-25 LAMP SALES

Table 133: EU-25 lamp sales, 1999-2004 (Source: rescaled based on population from original ELC sales data for the Western EU market)

Lamp Type	Quantity (000's)					
	1999	2000	2001	2002	2003	2004
LINEAR & SPECIAL PRODUCT FLUORESCENT LAMPS						
(a) T12	24.179	25.808	19.619	17.486	15.672	14.164
(b) T8 Halo phosphor	116.392	126.321	126.041	127.290	135.310	149.982
(c) T8 tri-phosphor		80.660	83.050	85.038	79.499	88.312
(d) T5 new (14 - 80w)	75.146				9.598	12.133
(e) All others (including T5 old types 4 - 13w and Special)	26.679	28.514	30.654	29.923	31.196	33.048
Total Linear and special product fluorescent lamps	242.397	261.303	259.365	259.736	271.274	297.639
COMPACT FLUORESCENT LAMPS						
(a) Retrofit	32.258	35.369	39.205	41.226	43.500	52.238
(b) Non-Retrofit	40.355	45.750	47.366	48.612	51.131	56.049
Total Compact fluorescent lamps	72.613	81.119	86.571	89.838	94.631	108.286
TUNGSTEN HALOGEN LAMPS						
(a) Single Ended, Mirrored (Low voltage)	42.638	47.587	46.814	48.018	50.222	53.107
(b) Linear (High voltage)	17.404	20.024	19.320	19.435	21.141	22.361
(c) Mains Halogen (Substitute for GLS and Reflector)	10.714	17.073	18.284	16.192	19.785	27.112
(d) LV Halogen Capsule				27.866	32.937	35.319
(e) HV Halogen Capsule				5.521	3.686	5.151
Total Tungsten halogen lamps	70.756	84.684	84.417	117.031	127.772	143.051
INCANDESCENT LAMPS						
(a) Reflector	110.052	126.601	129.744	135.008	137.746	123.208
(b) GLS (Including clear/pearl, candles, coloured & dec.)	925.118	977.008	966.826	956.600	978.737	1.102.092
Total Incandescent lamps	1.035.170	1.103.609	1.096.570	1.091.608	1.116.483	1.225.299
HIGH INTENSITY DISCHARGE LAMPS						
(a) All Mercury Lamps (including mixed)	8.711	9.333	8.501	8.542	8.151	7.938

(b) All Sodium lamps	8.801	9.151	10.265	10.206	10.457	10.982
(c) All Metal Halide lamps	5.649	6.935	7.531	8.011	8.958	10.714
<u>Total High Intensity Discharge lamps</u>	23.161	25.418	26.297	26.759	27.566	29.633
TOTAL	1.444.097	1.556.133	1.553.220	1.584.971	1.637.726	1.803.909

ANNEX I: CHARACTERIZATION OF THE EUROPEAN BUILDING STOCK

Table 134: Current floor area of European Office Buildings (Source: Novem, 1999 – SAVE project)

Country	Current Floor Area
	1000m ²
NORTH	
Denmark	15.060
Finland	11.295
Sweden	21.084
WEST	
Ireland	3.012
U.K	106.325
CENTRAL	
Austria	19.578
Belgium	23.343
Germany	162.801
Luxembourg	3.012
Netherlands	48.947
MID	
France	121.386
SOUTH	
South	145.923
Total E.U.-15	681.766

Table 135: Characterization of the “new-8” building stock

Building age	Small non-residential buildings (<1000m ²)	Non-residential buildings >1000m ²	Total non-residential	Total ⁷⁰	% non-residential of total building stock	
	Million m ²	Million m ²	Million m ²	Million m ²	%	
Estonia	<1975	3,1	5,3	8,4	40,0	21,0
	1975-1990	1,8	3,1	4,9	23,3	21,0
	1990-2001	0,2	0,4	0,6	2,9	20,7
	Total	5,1	8,8	13,9	66,2	21,0
Latvia	<1975	6,0	11,5	17,5	53,7	32,6
	1975-1990	3,0	5,8	8,8	26,8	32,8
	1990-2001	0,4	0,7	1,1	3,3	33,3
	Total	9,4	18,0	27,4	83,9	32,7
Lithuania	<1975	8,5	13,6	22,1	108,0	20,5
	1975-1990	3,0	4,7	7,7	37,6	20,5
	1990-2001	0,7	1,1	1,8	8,8	20,5
	Total	12,2	19,5	31,7	154,4	20,5
Baltic Republics	<1975	17,6	30,5	48,1	201,6	23,9
	1975-1990	7,8	13,6	21,4	87,7	24,4
	1990-2001	1,3	2,2	3,5	15,1	23,2
	Total	26,7	46,3	73	304,4	24,0
Poland	<1975	77,8	85,8	163,6	642,8	25,5
	1975-1990	39,7	43,7	83,4	327,6	25,5
	1990-2001	18,6	20,6	39,2	154,0	25,5
	Total	136,2	150,1	286,3	1124,3	25,5
Czech Republic	<1975	35,6	40,3	75,9	261,5	29,0
	1975-1990	12,2	13,8	26	89,8	29,0
	1990-2001	1,6	1,8	3,4	11,4	29,8
	Total	49,3	55,9	105,2	362,7	29,0
Slovakia	<1975	10,0	19,6	29,6	104,5	28,3
	1975-1990	6,1	12,0	18,1	64,2	28,2
	1990-2001	1,2	2,4	3,6	12,6	28,6
	Total	17,3	34,0	51,3	181,3	28,3
Hungary	<1975	27,4	30,8	58,2	214,9	27,1
	1975-1990	12,7	14,2	26,9	99,4	27,1
	1990-2001	2,9	3,3	6,2	23,0	27,0
	Total	43,0	48,3	91,3	337,3	27,1
Slovenia	<1975	4,8	6,1	10,9	39,5	27,6
	1975-1990	2,5	3,1	5,6	20,2	27,7
	1990-2001	0,8	1,0	1,8	6,6	27,3
	Total	8,1	10,2	18,3	66,3	27,6
Total CEEC⁷¹-4	<1975	77,8	96,8	174,6	620,4	28,1
	1975-1990	33,5	43,2	76,7	273,6	28,0
	1990-2001	6,5	8,4	14,9	53,5	27,9
	Total	117,8	148,4	266,2	947,5	28,1

⁷⁰ Other categories include: single-family house; apartment house (<1000m²); apartment house (>1000m²)

⁷¹ Central-Eastern European countries Czech Republic, Hungary, Slovakia and Slovenia (CEEC-4)

ANNEX J: OFFICE STOCK PROJECTIONS TO 2030: FROM EMPLOYMENT TO OFFICE DEMAND

Source: View on offices: Development of the regional office markets in the Netherlands, NYFER, 2001 commissioned by Neprom and KFN

Transition of agriculture and industry to a services economy is the main driving force of the increase in office stock. This stock has strongly increased over the past 10 years in the Netherlands, of 26 mio m² r.f.s. in 1989 to 36 mio m² r.f.s. in 1999. Over 10 years this stock increased with almost 40%. Of this 36 mio m² was in 1999 34 million m² in use. This stock calculations for that matter only comprise solitary office buildings, and thus not offices of the self-employed or office space in company complexes, hospitals and university buildings⁷²

Without having to know exactly the mechanism of company relocation and use of space a fairly reliable definition/picture of the relation between employment and office demand can be obtained based on analysis of panel data.⁷³

The results of the econometric analysis are presented in Table 136.

⁷² Source: Data file R.L. Bak; see : Bak, 1999: Kantorenatlas Nederland.

The file is composed based on own observations and pretends to have mapped 98% of all office space in the Netherlands. Only solitary office buildings over 500m² are included. Other sources assume a total office stock of 72,8 million m² in 1999. That number is obtained by multiplying total office employment (2,6 million) with an average use of space of 28 m² per person (See: ABNAMRO, 2001: The ABN AMRO dynamic office market model, p. 9, en: NVB, 2000: Thermometer kantoren, p. 34). The explanation of the difference is that here is calculated with m² b.r.s (Bruto rentable Floor space) and furthermore all office space is counted: thus also office space in different business premises and solitary office buildings being smaller than 500m². It is assumed that office premises with a floor surface >500m² make up 80% of all solitary office space and that solitary office buildings accommodate 70% of the total office surface in the Netherlands (See: De Wulf, 1994: Toekomst van de kantorenmarkt, p. 36). If these percentages are correct – and these are open to question- 36 mio m² r.f.s. in big solitary office buildings indicates a Total stock of 73 million m² b.f.s. in 1999, comparable to stock figures from other sources. This study always starts from the figures in the data file of R.L. Bak, thus in m² r.f.s. and only solitary office buildings >500m². The conversion factors are only used to be able to compare the results of this study with other prognoses

⁷³ Panel data analysis brings time series of different variables in connection. In this way can be analysed how the change of one variable corresponds to that of the other variable. In this case the development of office use per coropregion is taken as dependent (endogenous) variable in the model and the employment development in 12 different industry branches per coropregion as independent variables (exogenous). The estimated parameters indicate then whether and to which extent the change of employment in the diverse sectors (the 12 exogenous variables) can explain the change in office demand. Based on those results the model is reduced till the model with the greatest explanatory ability remained. In that model 3 exogenous variables (sectors) were left that together explain the best the change in office use. The height of the coefficient determines the proportion of the relation between dependent and independent variable. The t-value (number between brackets) is a measure for the statistic probability of the effect

Table 136: Effect of growth of employment on office use in coropregions, 1989-1999

Region	Effect of 1 additional employee in the sector on the office demand (in m ² r.f.s)	t-value ⁷⁴
	Coefficient	
G4 (Amsterdam, Den Haag, Rijnmond, Utrecht)		
Financial institutions	51,8	(14,1)**
Provision of business services	8,5	(5,2)**
Public administration	49,0	(28,5)**
Remaining coropregions		
Financial institutions	29,5	(6,4)**
Provision of business services	21,3	(19,3)**
Public administration	1,4	(2,7)**

Regression shows that 95% of the yearly additional office demand in the 4 big cities can be explained by the growth of employment in 3 sectors: Financial institutions, Provision of business services, and Public administration. Of all sectors initially comprised in the analysis the combination of these 3 showed to explain the development of office employment the most solid. The coefficients in Table 136 indicate that 1 additional job with a Financial institution on average explains an additional use of 51,8 m² r.f.s. office. A job in the Provision of business services explains on average an additional use of 8,5 m² r.f.s. office, and an additional job in public administration 49m².

The coefficients from Table 136 do not mean that every employee with a financial institution in Amsterdam occupies 51,8 m² office space and that an employee in the provision of business services settles for only 8,5 m². The coefficients indicate the statistical coherence between an additional job in a certain sector and additional office demand.

That this coefficient is relatively high for financial institutions means that probably a great part of the companies in that sector are office-holding companies. But even then 51,8 m² would be high compared to an average use of space of 29 m² r.f.s. per person. Employment with financial institutions will have to represent employment in other sectors. Those sectors are not expressed separately in the statistical analysis because they are directly related to employment at Financial institutions which in turn is strongly related to the demand for office space. The same holds for the coefficient for employment in public administration. The relative low coefficient for “provision of business services” means that firstly far from all employment in that sector is office-employment. This sector gathers-since the new sector classification of CBS dating from 1983-namely also evidently non-office-holding companies such as bicycle repaires, photographers, security companies, cleaning companies, repair companies, rental companies and employment agencies. But it can also imply that a part of the office demand in the provision of business services in the 4 big cities is expressed statistically indirect via the stronger correlating financial institutions or public administrations.

⁷⁴ T-value < 1,6: No significant effect
t-value > 1,6: 90% certainty significant
t-value > 2,0: 95% certainty significant

ANNEX K: EXPERT INQUIRY

Questionnaire:

EuP Office Lighting Questionnaire

VITO is performing on behalf of the European Commission a preparatory study for a possible implementing measure related to office lighting in the framework of the Eco-design of Energy Using Products (EuP) Directive (more info http://ec.europa.eu/enterprise/eco_design/index_en.htm).

This enquiry is part of the preparatory study and has for purpose to acquire data for a realistic EU25 environmental and economic impact model for office lighting. The objective is to base this study on available and realistic data.

We kindly ask for your contribution by completing this questionnaire. We assumed that you or your organization can help us to get the right information. If we made a wrong assumption, we urgently request you to send us the correct contact details of people or another organizations that could give us this kind of information..

You can follow the progress of our study on the project website:

<http://www.eup4light.net>

The market analysis of the report is based on large sets of market data and statistics. The current data set gives an in-depth view on the existing and new lighting installations in EU-25.

However, cultural differences between the different member states may cause some adaptations. The aim of the present questionnaire is to detect whether such cultural differences between member states exist.

Please e-mail this enquiry to info@eup4light.net before 21 December 2006

The answers should therefore give an impression of the situation in your country. Please fill in the questionnaire, based on average standard practices in your country.

Name :

Company :

Country :

1. Existing office building stock

1.1 At the level of office rooms, distinctions can be made between smaller office rooms and open space office rooms. Please ESTIMATE the distribution between these two types of offices. What percentage of the nett office floor area is being used for the two types ?

	Floor area of small offices (less than 30m ² or less than 6 persons per room)	Floor area of large offices (more than 30m ² and/or more than 6 persons per room)
<input type="checkbox"/>	over 90%	less than 10%
<input type="checkbox"/>	between 75% and 90%	between 10% and 25%
<input type="checkbox"/>	between 60% and 75%	between 25% and 40%
<input type="checkbox"/>	between 50% and 60%	between 40% and 50%
<input type="checkbox"/>	about 50%	about 50%
<input type="checkbox"/>	between 40% and 50%	between 50% and 60%
<input type="checkbox"/>	between 25% and 40%	between 60% and 75%
<input type="checkbox"/>	between 10% and 25%	between 75% and 90%
<input type="checkbox"/>	less than 10%	over 90%

Remarks :

1.2 At what rate are lighting installation currently being renewed on average in office buildings?

- 2. Every 5 years or faster
- 3. Between 5 and 10 years
- 4. Between 10 and 15 years
- 5. Between 15 and 20 years
- 6. Between 20 and 25 years
- 7. Between 25 and 30 years

1.1 Can you provide an estimate of the total office surface in your country?

Yes No

If, yes: m²

1.2 What is the yearly growth rate of this office surface stock?

.....% in year.....

2. Differences between the installed lighting and new lighting installations

2.1 What part of the installation uses currently electronic ballasts instead of electromagnetic ballasts in office rooms in fixed luminaires?

In existing lighting installations

In new lighting installations

.....% of the installed base has
electronic ballasts

.....% of the new installations has
electronic ballasts

Remarks :

2.2 Both ceiling mounted luminaires with direct light and suspended luminaires with direct/indirect light are available. What is the market penetration of suspended luminaires ?

In existing lighting installations

In new lighting installations

.....% of the installed base are
suspended luminaires.

.....% of the new installations are
suspended luminaires with
direct/indirect light.

Remarks :

1.1 Different types of lamps are available :

2. Fluorescent lamps (FL) in general:

- Compact Fluorescent Lamps (CFL)
- Linear Fluorescent Lamps (LFL) T8-type
- Linear Fluorescent Lamps (LFL) T5-type (14W or more)

3. Any other type

Please indicate an approximate level of market penetration for these different types of lamps, both for existing as for new installations in office buildings for the office task area with fixed luminaires.

Market share FOR FIXED CEILING MOUNTED OR SUSPENDED luminaires installed in the OFFICE ROOM (task area) :

In existing lighting installations

In new lighting installations

..... %FL

..... %FL

.....% other types

.....% other types

Detailed information about used FL types:

Detailed information about used FL types:

.....% CFL

.....% CFL

.....% T8 LFL

.....% T8 LFL

.....% T5 LFL

.....% T5 LFL

Remarks :

1. New lighting installations

What is the market situation for new lighting installations in office rooms in fixed luminaires?

Are the following lighting installation components currently standard for a NEW lighting installation ?

	In small offices (< 30 m ²)			In larger open space offices (> 30 m ² or more then 6 persons)		
Daylight sensors	Yes	No	Only for %	Yes	No	Only for %
Individual control for each	Yes	No	Only for %	Yes	No	Only for %
Presence detection	Yes	No	Only for %	Yes	No	Only for %

Remarks :

1.4 Relighting projects in existing office rooms are an important part of annual sales. Please give a price estimation of a standard relighting project ? Please also give the standard illumination level? (this price includes materials, installation, removal of the old installation and commissioning.)

Between €/m² and €/m²

Between.....€/luminaire and€/luminaire

Illuminance requirement anno 1990: 500 lux other lux

Illuminance requirement anno 2005: 500 lux other lux

Are there relighting subventions in your country: Yes No

Remarks :

Many thanks for your cooperation !

Results:

Only 4 countries filled in the questionnaire:

- Belgium: Catherine Lootens, Groen Licht Vlaanderen
- Germany: Stefan Fassbinder, Deutsches Kupferinstitut Berufsverband
- Spain: Juan J. González, Sluz S.L.
- United Kingdom: BRE for Market Transformation Programme.

Inquiry results:	Belgium	Germany	Spain	UK
Cellular offices %	50-60	60-75	25-40	25-40
Open plan (landscape) offices %	40-50	25-40	60-75	60-75
Functional luminaire life [y]	15-20	15-20	15-20	10-15
Office surface [10 ⁶ m ²]	23	600		apr/00
Growth rate office surface %	1	(1994) 6		1,3
Electronic ballast existing %	5	10	25	
Electronic ballast new %	70	50	65	*
* all new ballast sales electronic (replacem + new) %				45
A2 direct+indirect lighting, installed base	10	10	15	? (low)
A2 direct+indirect lighting, new	20	50	30	? (low)
Lamp types existing FL %	80	99	70	**
Lamp types existing other %	20	1	30	**
Lamp types existing FL CFL %	10	5	15	**
Lamp types existing FL T8 %	80	90	75	**
Lamp types existing FL T5 %	10	5	10	**
Lamp types new FL %	95	100	85	**
Lamp types new other %	5	0	15	**
Lamp types new FL CFL %	16	10	20	**
Lamp types new FL T8 %	52	45	50	**
Lamp types new FL T5 %	32	45	30	**
New lighting with daylight sensor (small) %	10	0	5	
New lighting with individual control (small) %	1	0	20	
New lighting with presence detection (small) %	25	0	10	
New lighting with daylight sensor (open plan) %	15	0	10	
New lighting with individual control (open plan) %	5	0	20	
New lighting with presence detection (open plan) %	25	0	15	
Relighting costs €/m ²	20-40		60-150	
Relighting costs €/luminaire	150-200		30-120	75-150
Illuminance requirement 1990 [lx]	300		500	300
Illuminance requirement 2005 [lx]	500		500	500
Relighting subventions	y		y	n

**No specific data for office, see table below 'Lamps survey for all non-domestic in UK'.

Lamps survey Non-domestic UK	Existing installations	Replacement & New sales Fluorescent
Lamp type	Number in millions	%
HID	6	
Incandescent	48	
Tungsten halogen	23	
CFL	29	13,8
LFL T12	33	7,3
LFL T8 Halophosphate	113	49
LFL T8 Triphosphor	61	20
LFL T5	17	9,2

ANNEX L: STAKEHOLDER LIST ON 19TH JUNE 2007.

CompanyName	First name	Last name	Meeting Office 02/04/2007	Country	Type company	national / international	interest lamp	interest luminaire	interest control gear	interest streetlighting	interest officelighting
N. Copernicus Observatory and Planetarium in Brno and Int. Dark Sky Assoc., Czech Section	Jan	Hollan		Czech Republic		national	■	■	■	■	■
ABB	Gianluca	Donato		Italy	Large		■	■	■	■	■
Agoria	Laurent	Hellebaut		Belgium		national	■	■	■	■	■
AIDI	Paolo	Soardo		Italy		national	■	■	■	■	■
AIE	Evelyne	Schellekens		Belgium	SME	international			■	■	■
Arcelor	Sigrid	Jacobs		Belgium	Large	international		■		■	■
Artemide	Bernard	Chevalier		France	Large		■	■	■		■
ASSIL / ANIE	Sandro	Benini	■	Italy		national	■	■	■	■	■
ASSIL / ANIE	Fabio	Pagano		Italy		national	■	■	■	■	■
Austrian Association of Electricity Companies (VEÖ)	Karl	Pitel		Austria		national	■	■	■	■	■
Austrian Standards Institute	Monika	Hartl		Austria		national	■	■		■	■
AustrianEnergyAgency	Thomas	Barth		Austria		national	■	■		■	■
BEGHELLI SPA	Fabio	Pedrazzi		Italy	Large			■			■
BIO Intelligence Service S.A.S.	Shailendra	Mudgal		France							
Boockmann GmbH	Kai	Boockmann		Germany	SME	international			■		
BRE Environment	Hilary	Graves		United Kingdom	Large		■	■	■	■	■
CCCME(China Chamber of Commerce)	Cai	Ming		China		national	■	■	■	■	■
CCI Slovenia	Zarko	Jenko		Slovenia		national	■	■	■	■	■
CE Lighting Ltd	Mick	Wilkes		China	Large	international	■	■	■		■
CELMA	Stéphanie	Mittelham		Belgium		international		■	■	■	■
Centre Design Est-France	Edith	Nanty		France	SME	national	■	■	■	■	■
CieloBuio	Fabio	Falchi		Italy		national	■	■		■	
Concord Lighting Ltd	Ray	Newnham		United Kingdom	Large		■	■	■	■	■
Concord:marlin	Jon	Hinton		United Kingdom	Large	international	■	■			■

CompanyName	First name	Last name	Meeting Office 02/04/2007	Country	Type company	national/ international	interest lamp	interest luminaire	interest control gear	interest streetlighting	interest office lighting
Danish Energy Authority	Peter	Nielsen		Denmark		national					
Danish Environmental Protection Agency	Janus	Lorentz-Petersen		Denmark							
Danish Illuminating Engineering Society	Kenneth	Munck		Denmark	SME	national	■	■	■	■	■
DISANO ILLUMINAZIONE SPA	Lorenzo	Franchi		Italy	Large	international		■		■	■
DKI Deutsches Kupferinstitut Berufsverband	Stefan	Fassbinder	■	Germany		national			■	■	■
Eamonn Bates Europe	Feodora	von Franz		Belgium	SME		■	■	■	■	■
Ecofys	Rogier	Coenraads		Netherlands	SME					■	■
Eden Energy	Hugues	Dailiez		France		national	■	■	■	■	■
ELC Federation	Gerald	Strickland		Belgium		international	■			■	■
Electricity of France	Odile	Le Cann		France	Large	national	■	■	■	■	■
ENDS Europe	Sonja	van Renssen		Belgium	Large	international				■	■
Energy piano	Casper	Kofod		Denmark	SME	national	■	■	■	■	■
Environment and Development Foundation	Albert	Chen		Taiwan	SME	national	■	■	■	■	■
ERCO Leuchten GmbH	Ralf	Wershoven	■	Germany		national		■		■	■
Especialidades Luminotecnicas S.A.	Marco Antonio	Lahoz Pfeiffer		Spain	Large				■	■	■
Essexnexans	Leonard	Danel		France	Large				■	■	■
Etap Lighting	Frans	Taeymans	■	Belgium	Large	international	■	■	■		■
ETAP NV	Luc	Truyen		Belgium	SME		■	■	■		■
ETAP NV	Ronny	Verbeeck		Belgium	Large	national	■	■	■	■	■
EuP network Germany	Dirk	Jepsen		Germany						■	■
EuroCommerce	Christel	Davidson		Belgium		international					■
Eurofer	Clare	Broadbent		Belgium		international					
European Commission	Andras	Toth		Belgium		international	■	■	■	■	■
European Copper Institute	Hans	De Keulenaer		Belgium		international				■	■
European Copper Institute	Sergio	Ferreira		Belgium		international	■	■		■	■
European Lamp Companies Federation	Jarita	Christie	■	Belgium		international	■				
Eutema Technology Management GmbH	Erich	Prem		Austria	SME		■	■	■	■	■

CompanyName	First name	Last name	Meeting Office 02/04/2007	Country	Type company	national/ international	interest lamp	interest luminaire	interest control gear	interest streetlighting	interest office lighting
EYÉY	Derya	Aydemir		Turkey		national	■	■	■	■	■
Federale Raad voor Duurzame Ontwikkeling	Stefanie	Hugelier		Belgium		national	■	■	■	■	■
Finnish Environment Institute	Ari	Nissinen		Finland		national				■	■
Foresite Systems	Rupert	Foxall		United Kingdom	SME	international	■	■	■	■	■
FOTISTIKI SA	Pakis	Sotiropoulos		Greece	SME					■	■
Foundation of taiwan Industry service	Dinah	Tai		Taiwan	SME	green NGO	■	■	■	■	■
Foundation of taiwan Industry service	Lin	Yei		Taiwan	SME	national	■	■			
Fraunhofer IZM	Karsten	Schischke		Germany		national	■	■	■	■	■
Future Electronics	Mauro	Ceresa		Italy	Large	international	■	■	■	■	■
General Electric	Ferenc	Papp		Hungary	Large		■				
Genesis Energy	Kelvin	Blackwell		New Zealand	Large	national					■
German Energy Agency	Tobias	Marsen		Germany		national	■	■	■	■	■
Groen Licht Vlaanderen	Catherine	Lootens	■	Belgium	SME	national	■	■	■	■	■
Helvar	Max	Björkgren		Finland	Large	international			■	■	■
Helvar	Leena	Tähkämö		Finland	SME	international	■	■		■	■
Idman Oy	Riikka	Lahdenperä		Finland	SME		■	■	■	■	■
Illuminating Engineering Society of Finland	Heikki	Härkönen		Finland		national	■	■	■	■	■
IMQ SpA	Paolo	Gianoglio		Italy	Large		■	■	■	■	■
INDAL	Federico	Arias		Spain	Large	international	■	■	■	■	■
Industria b.v.	Nic	van Koningsbruggen		Netherlands	Large		■	■	■	■	
Industrias Ventura S.L.	Rafael	del Aguila Alvarez		Spain	SME			■	■		
Industry Technology Research Insittute	Nick, Tzu-Yar	Liu		Taiwan		national	■				■
Industry Technology Research Insittute	George, Shin-Ru	Tang		Taiwan		national	■				■
INECSA	Manel	Gonzalez		Spain	SME	international	■	■	■	■	■
Infineon Technologies	Werner	Ludorf		Germany	Large		■	■	■	■	■
Infineon Technologies AG	Michael	Herfurth	■	Germany	Large		■		■		■
Infineon Technologies AG	Manfred	Schlenk	■	Germany	Large	international	■	■	■	■	■

CompanyName	First name	Last name	Meeting Office 02/04/2007	Country	Type company	national/ international	interest lamp	interest luminaire	interest control gear	interest streetlighting	interest office lighting
Infra Engineering	Menno	Van Noort		Netherlands	Large						
International CFL Harmonisation Initiative	Stuart	Jeffcott		United Kingdom							
International Dark-Sky Association Europe	Friedel	Pas		Belgium		international				■	
IREM SpA	Marco	Ugo		Italy	SME					■	
ISGR	Hisao	Nakashima		Japan	SME	national				■	■
IVF Industrial Research and Development Corp.	Anna Karin	Jönbrink		Sweden		national	■	■	■	■	■
KERP	Andreas	Schiffleitner		Austria	SME	international	■	■	■	■	■
KREIOS	Lieven	Vanhooydonck	■	Belgium	SME		■	■	■	■	■
LABORELEC	Marc	Vanden Bosch	■	Belgium		international	■	■		■	■
LG Electronics	Hee Il	Park		KOREA	Large	international				■	
Light Consult International	Axel	Stockmar		Germany			■	■	■	■	■
Lighting Industry Federation Ltd	Bernard	Pratley		United Kingdom	SME	national	■	■	■	■	■
lisheng	Jeff	Zhu		China	SME	international	■			■	■
Lund University	Carl	Dalhammar		Sweden		national	■	■	■	■	■
Lysteknisk Selskab	Ulrich	Klausen		Denmark	SME		■	■	■	■	■
Lysteknisk Selskab		Velk		Denmark		national	■	■	■	■	■
MA 39-VFA	Nikolaus	Thiemann		Austria	Large	national	■	■		■	■
Metrolight Inc.	Jonathan	Hollander		United States	Large	international	■		■		
Ministry of Economy of the Slovak Republic	Jan	Magyar		Slovakia		national	■	■	■	■	■
Ministry of Economy, Labour and Entrepreneurship	Hrvoje	Medarac		Croatia		national	■	■	■	■	■
MUSEUM AM SCHÖLERBERG	Andreas	Hänel		Germany							
NEMA	Craig	Updyke		United States	Large	national	■	■	■	■	■
Neonlite	Tony	Yu		China	Large	international	■	■	■	■	■
Neonlite Electronic & Lighting (HK) Ltd	Debbie	Tam		China	SME	national	■	■	■	■	■
Nowak Licht und Strom e.K.	Alexander	Nowak		Germany	SME		■	■	■	■	■
Odyssey Energy Limited	Roger	Loveless		New Zealand	SME					■	
Öko-Institut e.V.	Dietlinde	Quack		Germany		national	■				■

CompanyName	First name	Last name	Meeting Office 02/04/2007	Country	Type company	national/ international	interest lamp	interest luminaire	interest control gear	interest streetlighting	interest office lighting
OSRAM	Josef	Stienen		Germany	Large		■	■	■	■	■
OSRAM GmbH	Richard	Lothholz	■	Germany	Large						
OSRAM-Italy	Pietro	Tedesco		Italy	Large	international	■	■	■	■	■
Palmstep Electronics Ltd	Jan	Christlieb		Mauritius	Large	international	■	■	■		■
Panasonic MEI	Gareth	Rice		Japan	Large	international	■	■		■	■
PETITJEAN	Helet	Sebastien		France	SME	national	■	■	■	■	
Philips	Bert	Kenis		Belgium	Large	international	■	■	■	■	
Philips	Paul	Wu		China	Large		■	■	■	■	■
Philips AG Lighting	Job	Daams		Switzerland	Large		■	■	■	■	■
Philips Electronics	Peter	Adriaans		Netherlands	Large	international	■	■	■	■	■
Philips Lighting	Frank	Altena		Netherlands	Large		■	■	■	■	■
Philips Lighting	Eddy	Ceelen		Netherlands	Large	international	■	■	■	■	■
Philips Lighting	Robert	Class		Germany	Large	international		■		■	■
Philips Lighting	Gil	Soto Tolosa		Netherlands	Large	international	■	■	■	■	
Philips Lighting	Jan	Zeguers		Netherlands	Large			■	■		■
Philips Lighting BV	Marcel	Jacobs		Netherlands	Large	international	■	■	■	■	■
Philips Lighting Turnhout	Dirk	Smeyers		Belgium	Large	international	■	■	■	■	
Philips Lys A/S	Hans Jørgen	Jacobsen		Denmark	Large	national		■	■	■	■
Philips Nederland BV	Jan	Veldhuis	■	Netherlands	Large	international	■	■	■	■	■
Planning & Architecture	Thomas	Christoffersen		Denmark	Large	international	■	■	■	■	■
PlesTech Ltd	Graham	Adams		United Kingdom	SME	international	■	■	■	■	■
Prismalence AB	Lars	Bergkvist		Sweden	SME					■	
Rijkswaterstaat	Bob	Hamel		Netherlands		national		■	■	■	
R-Tech	Marc	Gillet		Belgium	Large		■	■	■	■	
SAFE	Giuse	Togni		Switzerland		national				■	
Schröder Uitrusting	Rob	Verbeelen		Belgium	SME			■			
SenterNovem	Ruud	van Wordragen		Netherlands		national				■	

CompanyName	First name	Last name	Meeting Office 02/04/2007	Country	Type company	national/ international	interest lamp	interest luminaire	interest control gear	interest streetlighting	interest office lighting
Sibelga	Benedicte	Collard		Belgium	Large	national	■	■	■	■	■
Siteco	Oliver	Scopes		United Kingdom	Large		■	■	■	■	
Siteco Beleuchtungstechnik GmbH	Kai Hendrik	Sabla		Germany	SME	international					■
Siteco Beleuchtungstechnik GmbH	Bernhard	Schroll		Germany	SME	international		■		■	■
SLI	Christian	Brehm		Germany	Large	international	■	■	■	■	■
SLI Sylvania	Wannong	Eckhardt		Germany	Large	international	■	■	■	■	■
SLI Sylvania	Rudy	Geens		Belgium	Large	international	■	■	■	■	■
STU FEI Bratislava	Dionyz	Gasparovsky		Slovakia		national				■	■
Sylvania	Nicole	Loysch		Belgium	Large	international	■				
Syndicat Eclairage	Jacques	Villat		France	SME	national	■	■	■	■	■
Synergrid	Koen	Wouters		Belgium		national				■	
Technical University Iasi	Dorin	Lucache		Romania	SME	international	■	■		■	■
Technology Industries of Finland	Carina	Wiik		Finland		national		■	■	■	■
Thanglong Neon Co	Nguyen	Van Tien		Noord-Vietnam.	SME		■	■	■	■	
The Centre	Jacek	Truszczynski		Belgium	SME		■	■	■	■	■
The Danish Electricity Saving Trust	Poul Erik	Pedersen	■	Denmark							
The Lighting Association	Keven	Kearney		United Kingdom		national	■	■	■	■	■
Thorn Lighting Ltd	Lou	Bedocs		United Kingdom	Large	international	■	■	■	■	■
Thorn Lighting Ltd	Peter	Thorns		United Kingdom	Large		■	■	■	■	■
TridonicAtco GmbH & Co KG	Roy	Vageskar		Austria	Large	international			■		
TRILUX	Jan	Van Riel		Belgium	Large	international	■	■	■	■	■
Troyes University of Technology	Fabrice	Mathieux		France		national	■	■	■	■	■
Troyes University of Technology	Alexandre	Diepdalle		France		national	■	■		■	
Tungsram-Schröder Zrt	Péter	Szwarcz		Hungary	SME	international		■		■	
TUV	Gary	Hu		China		international	■	■			■
TUV Rheinland	Adams	Liu		China	Large	international	■	■	■	■	■
TWI Ltd	David	Calder		United Kingdom		international	■	■	■	■	■

CompanyName	First name	Last name	Meeting Office 02/04/2007	Country	Type company	national/ international	interest lamp	interest luminaire	interest control gear	interest streetlighting	interest officelighting
UK Market Transformation Programme	Hilary	Graves	■	United Kingdom		national	■	■	■	■	■
VITO	Theo	Daems		Belgium							
VITO	Bart	Jansen	■	Belgium		national	■	■	■	■	■
VITO	Dries	Maes		Belgium	Large	international					
VITO	Veronique	Van Hoof		Belgium		national				■	■
VITO	Paul	Van Tichelen	■	Belgium							
WTCB - CSTC	Arnaud	Deneyer		Belgium	SME	national	■	■	■		■
WWF Switzerland	Anette	Michel		Switzerland		international					■
Zumtobel Lighting	Peter	Dehoff		Austria	Large		■	■	■		■
ZVEI	Norbert	Wittig		Germany	SME	national			■		
ZVEI - Zentralverband Elektrotechnik- und Elektronikindustrie e. V.	Dieter	Schornick		Germany	SME	national	■	■	■	■	■
	Tachibana	Hirokazu		Japan	Large	national	■			■	■

Some stakeholders are not mentioned in the list above, because they have expressed their will to be not officially published in this report.